

INSTALLATION MANUAL

PRODUCT NAME : Medium ALPHA Round - ID without Base



IP66

No.	Input	Ordering Code
1.	220-240V~ 50/60Hz	5962-A/B/D/H/N-3/4/5/A-537-XX
2.		5962-A/B/D/H/N-3/4/5/A-538-XX
3.		5962-A/B/D/H/N-3/4/5/A-539-XX
4.		5962-A/B/D/H/N-3/4/5/A-534-XX
5.		5962-A/B/D/H/N-3/4/5/A-535-XX
6.		5962-A/B/D/H/N-3/4/5/A-536-XX
7.		5962-4-3/4/5/A-286-XX
8.		5962-4-3/4/5/A-289-XX

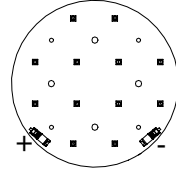

1-6

Light Emitting Diodes
(LED)

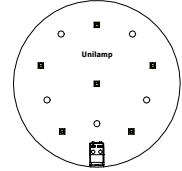

7-8

Light Emitting Diodes
(LED)

1

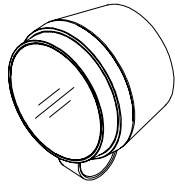

Medium ALPHA Round
ID with out base

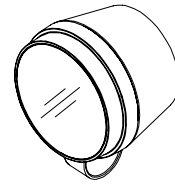
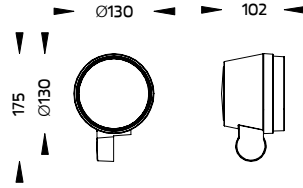

2

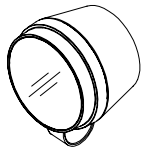

Medium ALPHA Round ID
On/Off , CASAMBI

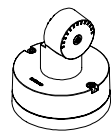

Round base for Ground mount [On,Off]
[pre-assembled from factory]
Ordering Code/รหัสสั่งซื้อ : AUN-MOT-0021-XX

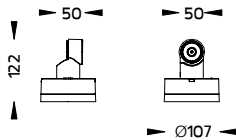

3

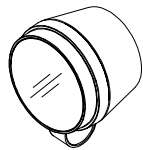

Medium ALPHA Round ID
DIM 1-10V , DALI

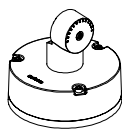

Round base for Ground mount [1-10V or Dali]
[pre-assembled from factory]
Ordering Code/รหัสสั่งซื้อ : AUN-MOT-0022-XX

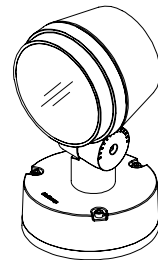
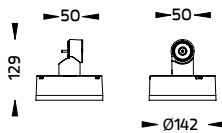

4

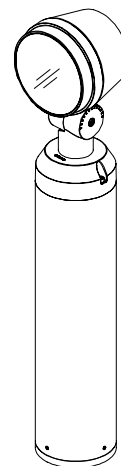
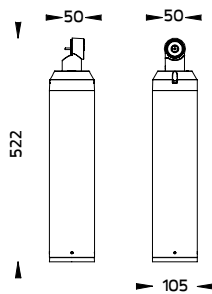
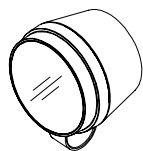

Medium ALPHA Round ID
On/Off , CASAMBI

Short Pole. [On,Off] [pre-assembled from factory]
Ordering Code/รหัสสั่งซื้อ : AUN-POL-0043-XX

5

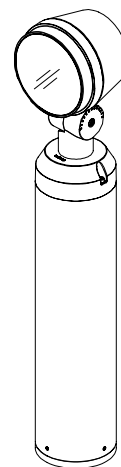
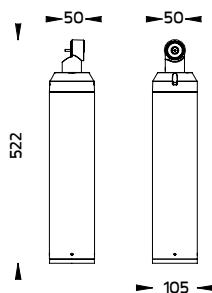
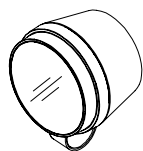

Medium ALPHA Round ID
DIM 1-10V , DALI

Short Pole. [1-10V or Dali] [pre-assembled from factory]
Ordering Code/รหัสสั่งซื้อ : AUN-POL-0044-XX

6

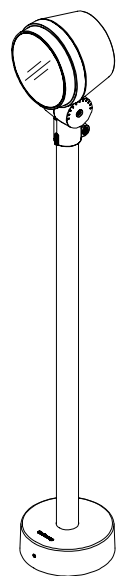
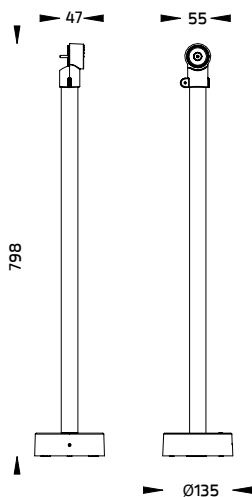
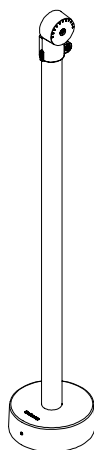
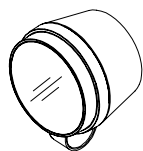

Medium ALPHA Round ID
On/Off , CASAMBI

Aluminium Arm L 740mm. [On/Off] [pre-assembled from factory]
Ordering Code/รหัสสั่งซื้อ : AUN-MOT-0018-XX

7

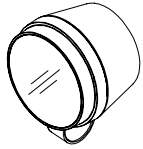

Medium ALPHA Round ID
DIM 1-10V , DALI

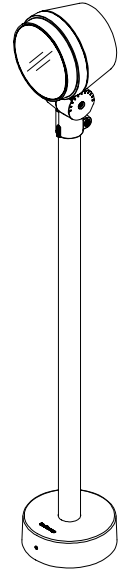
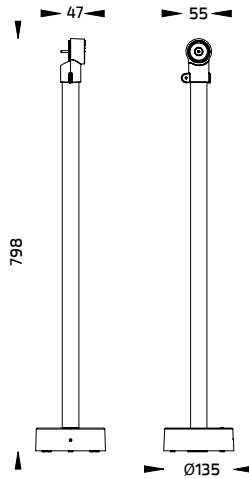
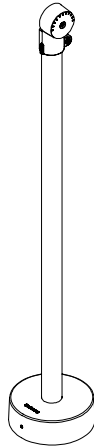

Aluminium Arm L 740mm. [1-10V or DALI] (pre-assembled from factory)
Ordering Code/รหัสสั่งซื้อ : AUN-MOT-0019-XX

8

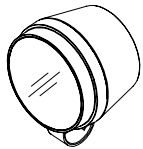

Medium ALPHA Round ID
On/Off , CASAMBI

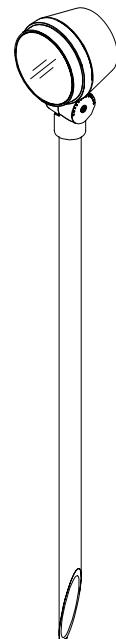
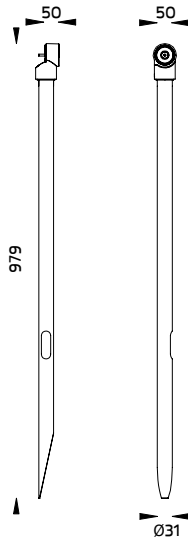

Aluminium Earth Spike L 900mm. [On/Off] (pre-assembled from factory)
Ordering Code/รหัสสั่งซื้อ : AUN-ESP-0008-XX

9

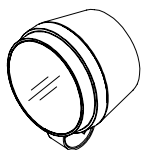

Medium ALPHA Round ID
DIM 1-10V , DALI

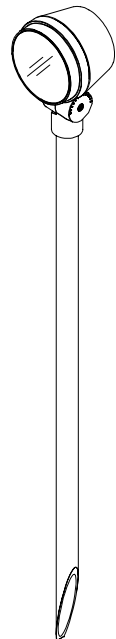
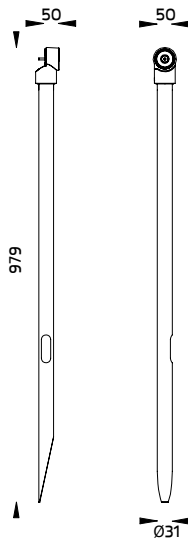

Aluminium Earth Spike L 900mm. [1-10V or DALI] (pre-assembled from factory)
Ordering Code/รหัสสั่งซื้อ : AUN-ESP-0009-XX

10

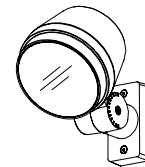
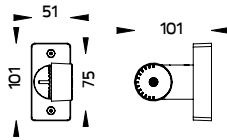
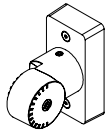
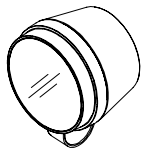

Medium ALPHA Round ID
On/Off , CASAMBI

Pole mount adaptor for square pole. [On/Off] pre-assembled from factory)
Ordering Code/รหัสสั่งซื้อ : AUN-MOT-0038-XX

11

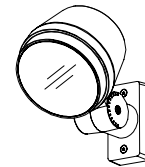
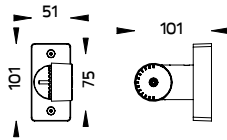
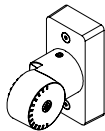
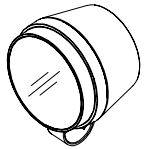

Medium ALPHA Round ID
DIM 1-10V , DALI

Pole mount adaptor for square pole. [1-10V or DALI] (pre-assembled from factory)
Ordering Code/รหัสสั่งซื้อ : AUN-MOT-0039-XX

12

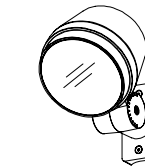
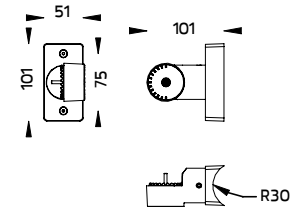
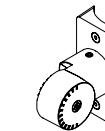
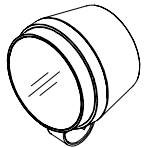

Medium ALPHA Round ID
On/Off , CASAMBI

Pole mount adaptor for pole dia 60mm. [On/Off] (pre-assembled from factory)
Ordering Code/รหัสสั่งซื้อ : AUN-MOT-0032-XX

13

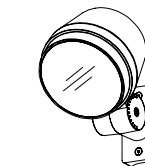
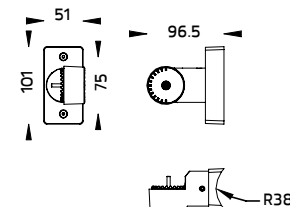
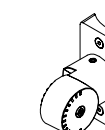
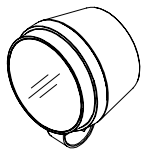

Medium ALPHA Round ID
On/Off , CASAMBI

Pole mount adaptor for pole dia 76mm. [On/Off] (pre-assembled from factory)
Ordering Code/รหัสสั่งซื้อ : AUN-MOT-0034-XX

14

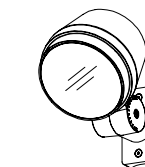
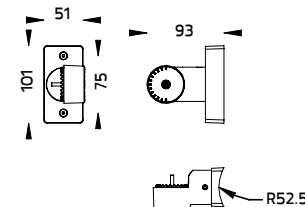
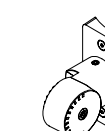
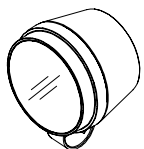

Medium ALPHA Round ID
On/Off , CASAMBI

Pole mount adaptor for pole dia 102-105mm. [On/Off] (pre-assembled from factory)
Ordering Code/รหัสสั่งซื้อ : AUN-MOT-0036-XX

15

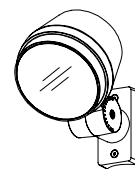
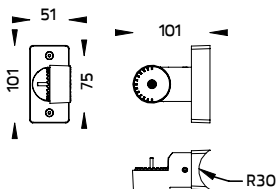
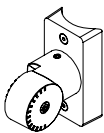
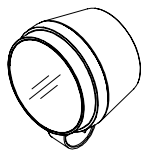

Medium ALPHA Round ID
DIM 1-10V , DALI

Pole mount adaptor for pole dia 60mm. [1-10V or DALI] [pre-assembled from factory]
Ordering Code/รหัสสั่งซื้อ : AUN-MOT-0033-XX

16

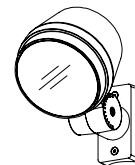
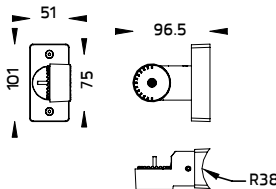
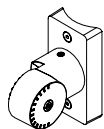
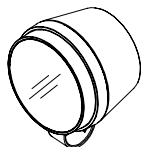

Medium ALPHA Round ID
DIM 1-10V , DALI

Pole mount adaptor for pole dia 76mm. [1-10V or DALI] [pre-assembled from factory]
Ordering Code/รหัสสั่งซื้อ : AUN-MOT-0035-XX

17

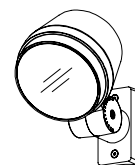
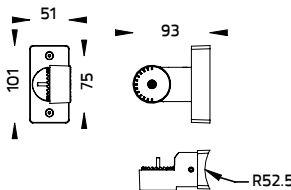
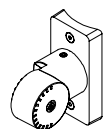
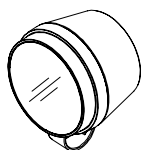

Medium ALPHA Round ID
DIM 1-10V , DALI

Pole mount adaptor for pole dia 102-105mm. [1-10V or DALI] [pre-assembled from factory]
Ordering Code/รหัสสั่งซื้อ : AUN-MOT-0037-XX

18

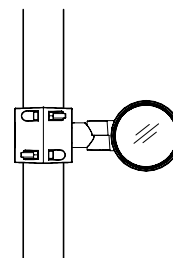
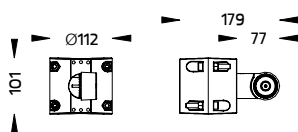
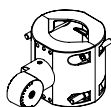
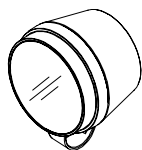

Medium ALPHA Round ID
On/Off , CASAMBI

Pole Clamp Single Side Diameter 60-76mm. [On/Off]
[pre-assembled from factory]
Ordering Code/รหัสสั่งซื้อ : AUN-CLP-0040-XX

19

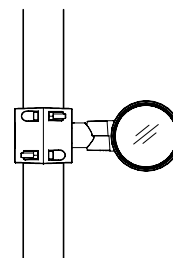
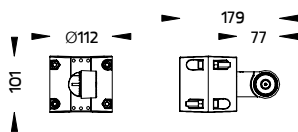
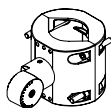

Medium ALPHA Round ID
DIM 1-10V , DALI

Pole Clamp Single Side Diameter 60-76mm. [DIM 1-10V , DALI]
[pre-assembled from factory]
Ordering Code/รหัสสั่งซื้อ : AUN-CLP-0041-XX

20

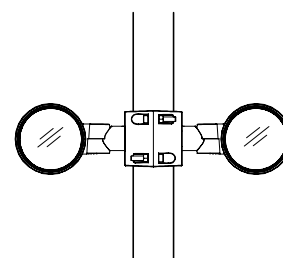
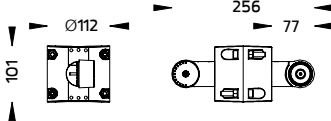
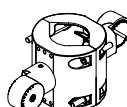

Medium ALPHA Round ID
On/Off , CASAMBI

Pole Clamp Double Side Diameter 60-76mm. [On/Off]
[pre-assembled from factory]
Ordering Code/รหัสสั่งซื้อ : AUN-CLP-0044-XX

21

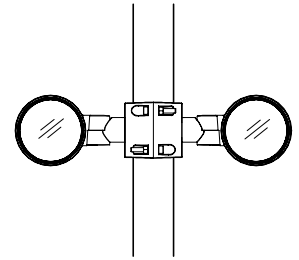
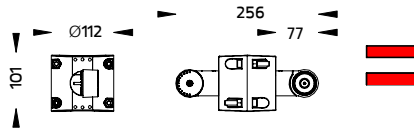
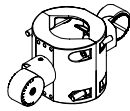
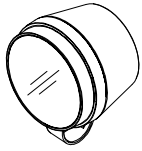

Medium ALPHA Round ID
DIM 1-10V , DALI

Pole Clamp Double Side Diameter 60-76mm. (DIM 1-10V , DALI)
[pre-assembled from factory]
Ordering Code/รหัสสั่งซื้อ : AUN-CLP-0045-XX

22

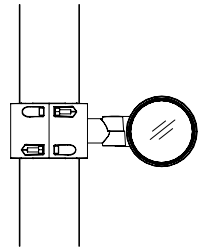
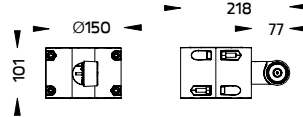
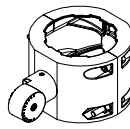
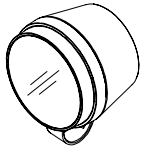

Medium ALPHA Round ID
On/Off , CASAMBI

Pole Clamp Single Side Diameter 102-105mm. (On/Off)
[pre-assembled from factory]
Ordering Code/รหัสสั่งซื้อ : AUN-CLP-0042-XX

23

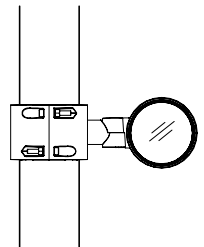
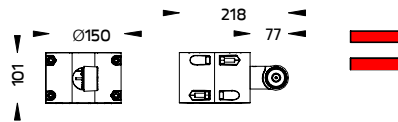
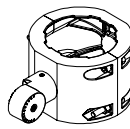
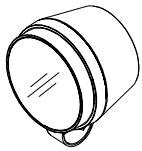

Medium ALPHA Round ID
DIM 1-10V , DALI

Pole Clamp Single Side Diameter 102-105mm. (DIM 1-10V , DALI)
[pre-assembled from factory]
Ordering Code/รหัสสั่งซื้อ : AUN-CLP-0043-XX

24

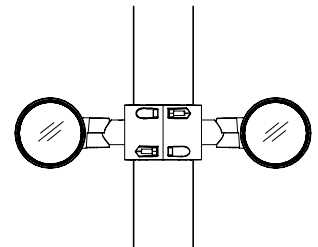
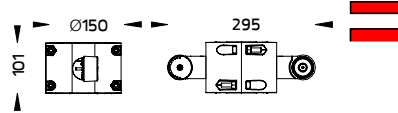
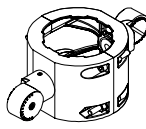
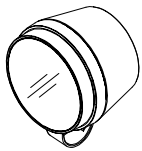

Medium ALPHA Round ID
On/Off , CASAMBI

Pole Clamp Single Side Diameter 102-105mm. (On/Off)
[pre-assembled from factory]
Ordering Code/รหัสสั่งซื้อ : AUN-CLP-0046-XX

25

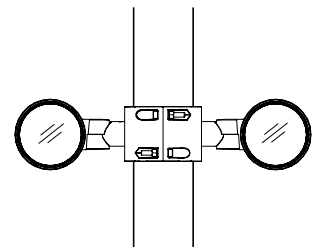
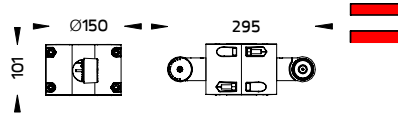
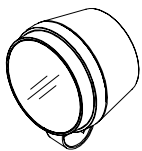

Medium ALPHA Round ID
DIM 1-10V , DALI

Pole Clamp Single Side Diameter 102-105mm. (DIM 1-10V , DALI)
[pre-assembled from factory]
Ordering Code/รหัสสั่งซื้อ : AUN-CLP-0047-XX

26

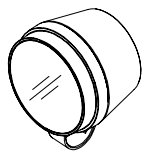

Medium ALPHA Round ID
On/Off , CASAMBI

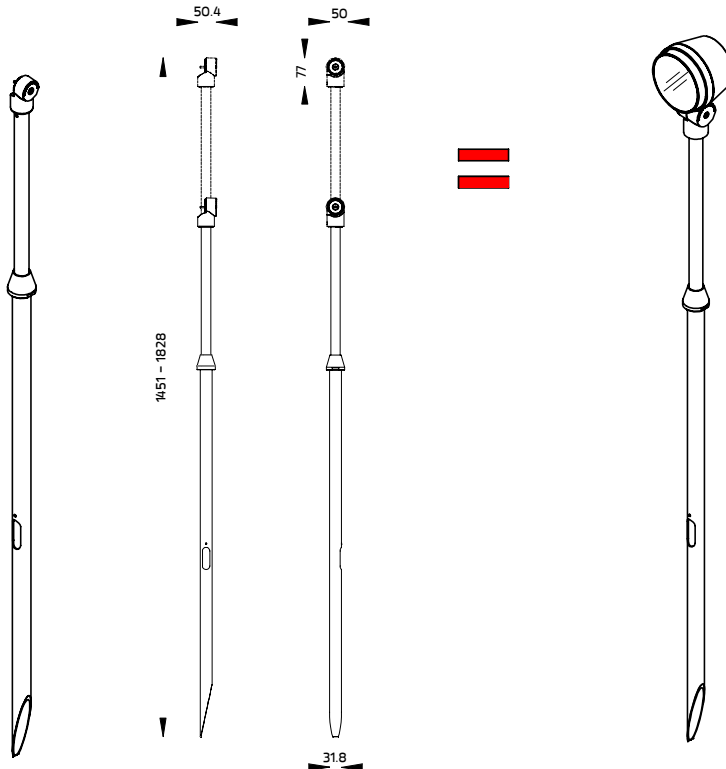

Adjustable Aluminium Earth Spike L 900-1300mm. [On/Off]
[pre-assembled from factory] for Medium ALPHA Round - ID
Ordering Code/รหัสสั่งซื้อ : AUN-ESP-0023-XX

27

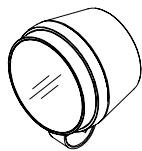

Medium ALPHA Round ID
DIM 1-10V , DALI

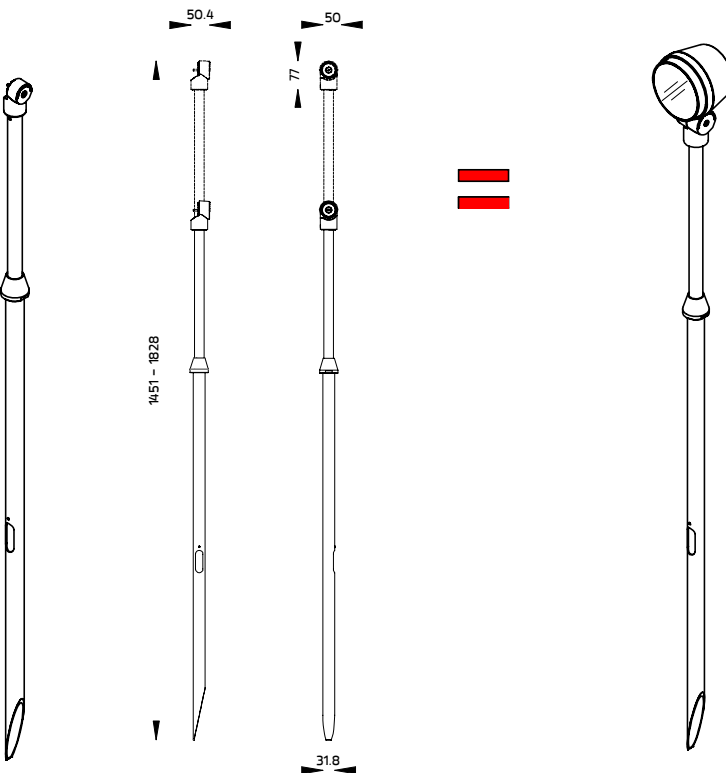

Adjustable Aluminium Earth Spike L 900-1300mm. [1-10V or DALI]
[pre-assembled from factory] for Medium ALPHA Round - ID
Ordering Code/รหัสสั่งซื้อ : AUN-ESP-0024-XX

28

⚠ Use appropriate installation material depending on installation conditions.
เลือกวัสดุและอุปกรณ์ยึดที่เข้ากับพื้นที่และประเภทการติดตั้ง

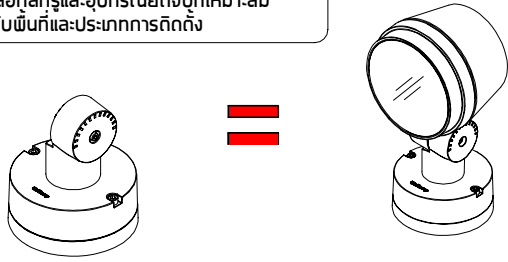

Round base for Ground mount (On,Off)
[pre-assembled from factory]
Ordering Code/รหัสสั่งซื้อ : AUN-MOT-0021-XX

Wall plug anchor size ขนาดพุกยึดผนัง		Screw size ขนาดสกรูยึดปลั้ว		
D	L	D	H	L
Ø7 mm./มม.	37 mm./มม.	Ø4 mm.	Ø9 mm.	38 mm.

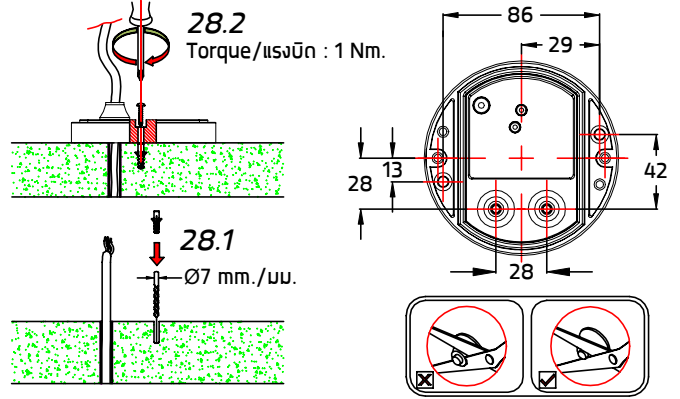

29

⚠ Use appropriate installation material depending on installation conditions.
เลือกวัสดุและอุปกรณ์ยึดที่เข้ากับพื้นที่และประเภทการติดตั้ง

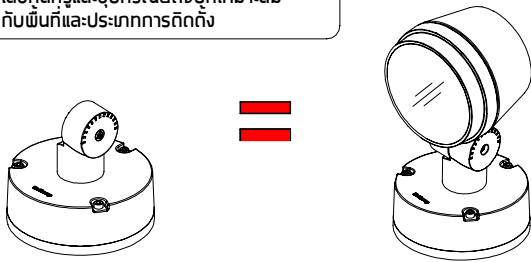

Round base for Ground mount (1-10V or Dali)
[pre-assembled from factory]
Ordering Code/รหัสสั่งซื้อ : AUN-MOT-0022-XX

Wall plug anchor size ขนาดพุกยึดผนัง		Screw size ขนาดสกรูยึดปลั้ว		
D	L	D	H	L
Ø7 mm./มม.	37 mm./มม.	Ø4 mm.	Ø9 mm.	38 mm.

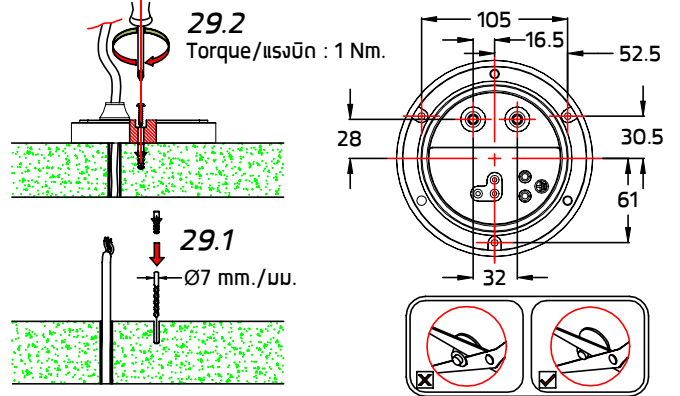

30 For On-off System and CASAMBI System.
สำหรับระบบเปิด-ปิด และระบบ CASAMBI

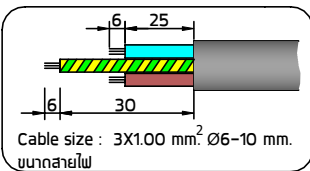
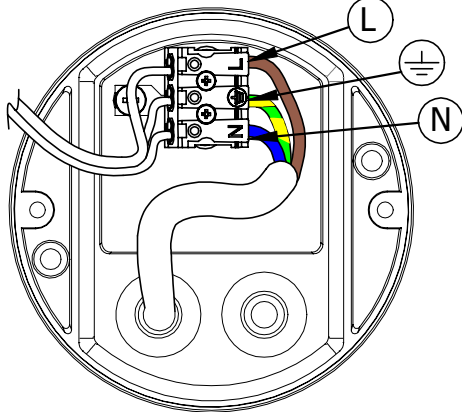

31

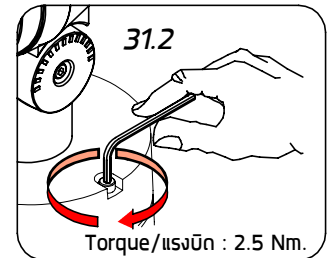
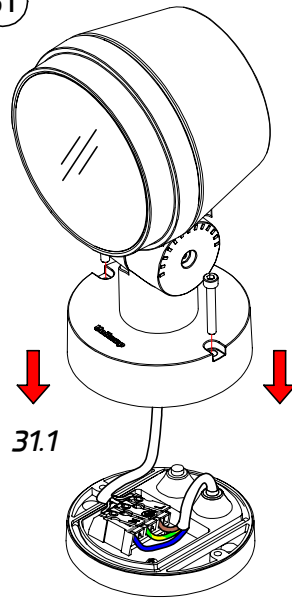

Torque/แรงบิด : 2.5 Nm.

32

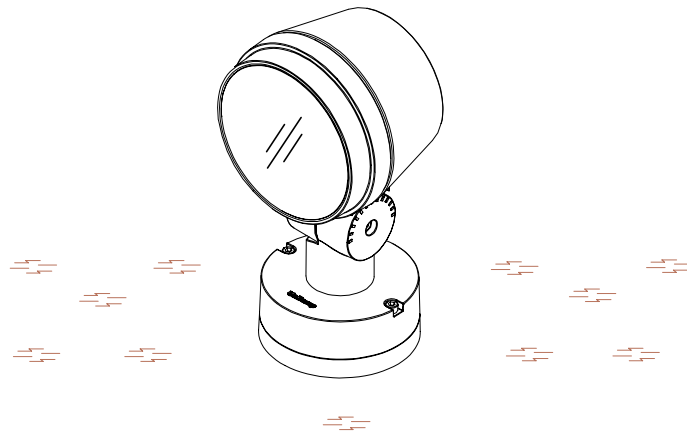

Installation complete
ติดตั้งเสร็จสมบูรณ์

33

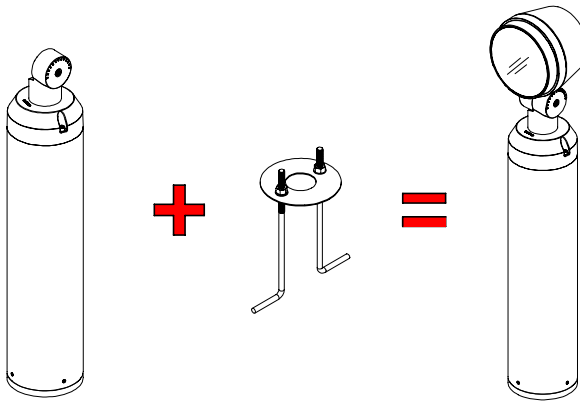

Short Pole. [pre-assembled from factory]
Ordering Code/รหัสสั่งซื้อ : AUN-POL-0043-XX , AUN-POL-0044-XX

34

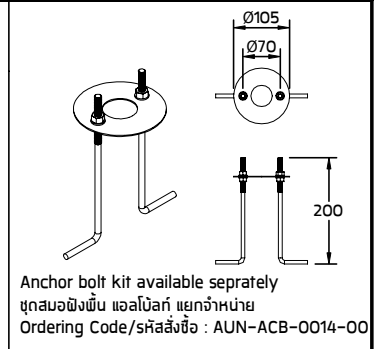
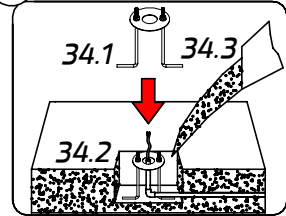

Anchor bolt kit available separately
ชุดสมอฝังพื้น แอลโบลท์ แยกจำหน่าย
Ordering Code/รหัสสั่งซื้อ : AUN-ACB-0014-00

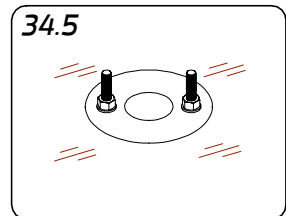
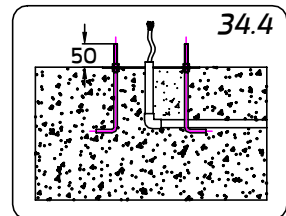

35

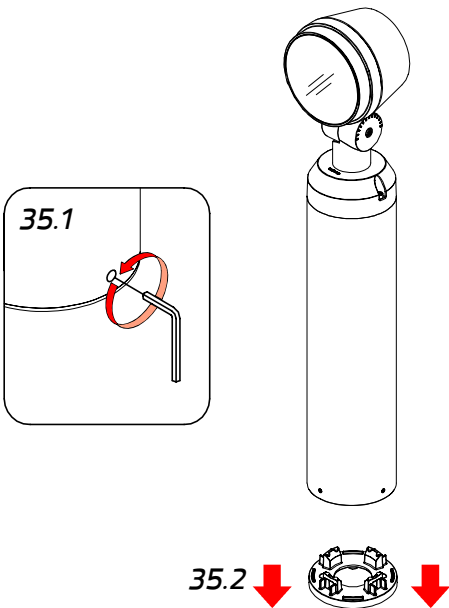

36

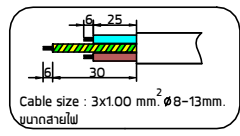
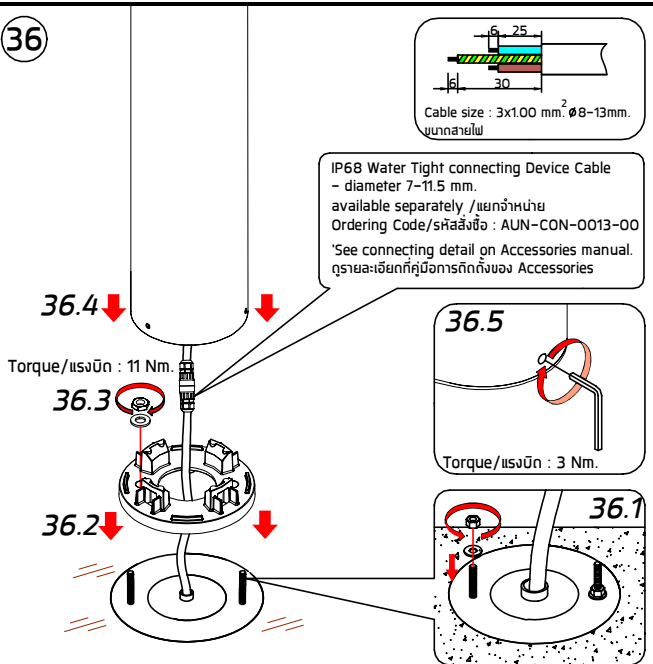

IP68 Water Tight connecting Device Cable - diameter 7-11.5 mm. available separately / แยกจำหน่าย
Ordering Code/รหัสสั่งซื้อ : AUN-CON-0013-00
*See connecting detail on Accessories manual. กรุณาละเอียดที่คู่มือการติดตั้งของ Accessories

Torque/แรงบิด : 11 Nm

Torque/แรงบิด : 3 Nm

37

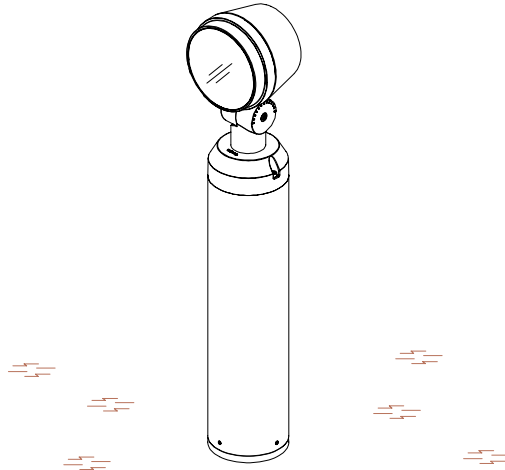

Installation complete
ติดตั้งเสร็จสมบูรณ์

38

⚠ Use appropriate installation material depending on installation conditions.
เลือกวัสดุและอุปกรณ์ยึดจับที่เหมาะสมกับพื้นที่และประเภทการติดตั้ง

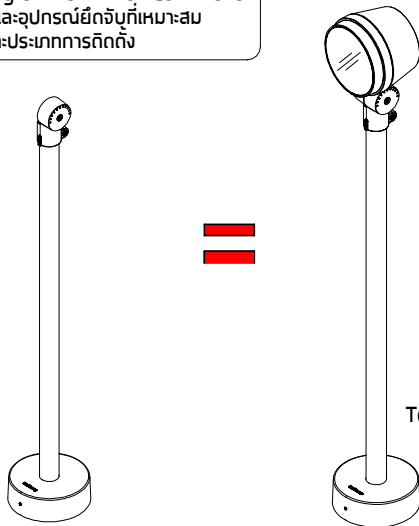

Aluminium Arm L 900mm. (pre-assembled from factory)
Ordering Code/รหัสสั่งซื้อ : AUN-MOT-0018-XX , AUN-MOT-0019-XX

Wall plug anchor size ขนาดตะกั่วฝังผนัง		Screw size ขนาดสกรูยึดผนัง
D	L	
Ø7 mm./มม.	37 mm./มม.	Ø4 mm. Ø9 mm. 38 mm.

38.1

Ø7 mm./มม.

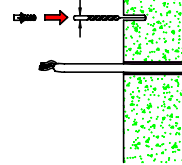

38.2

Torque/แรงบิด : 1 Nm.

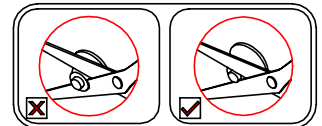
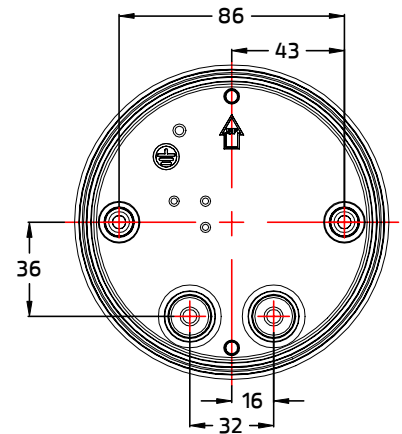
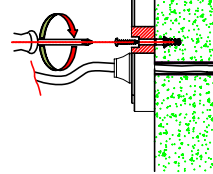

39

⚠ Bush protected against dripping water.
บุชป้องกันน้ำซึมเข้าตัวโคม

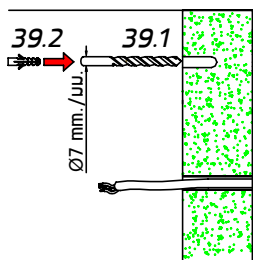

39.2

Torque/แรงบิด : 1.0 Nm.

39.3

Torque/แรงบิด : 1.0 Nm.

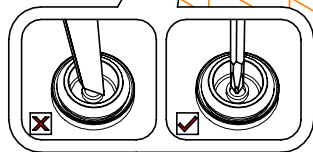

40

For On-off System and CASAMBI System.
สำหรับระบบเปิด-ปิด และระบบ CASAMBI

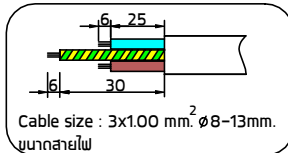
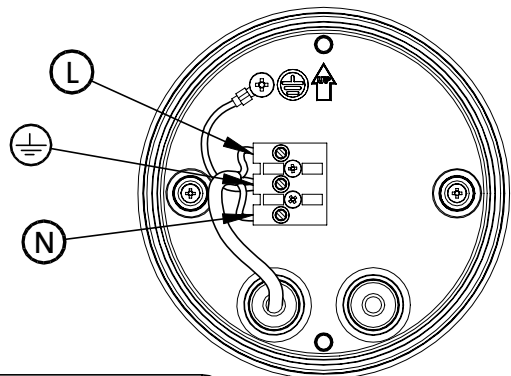

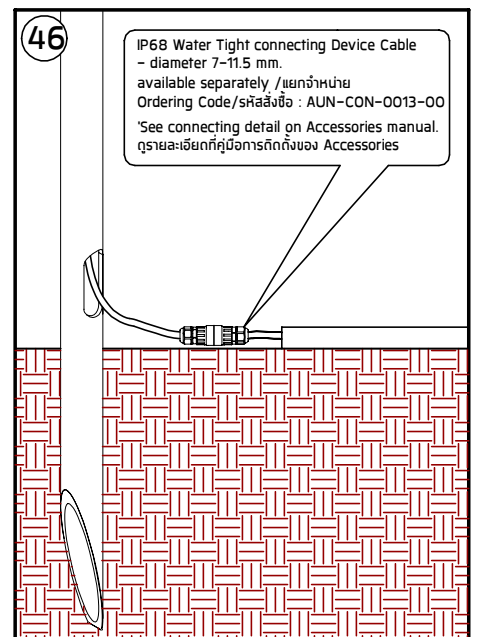
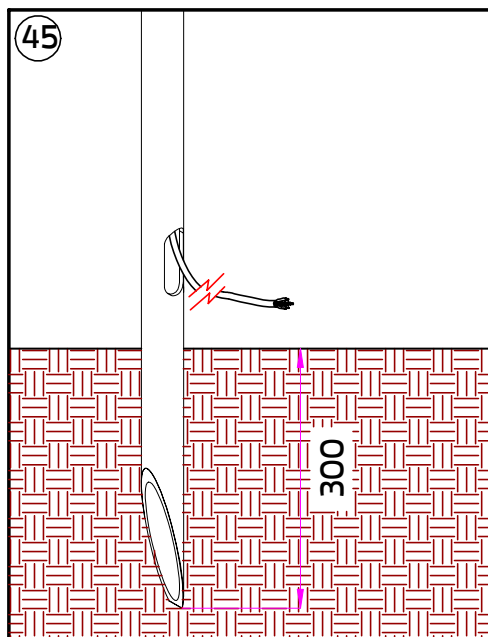
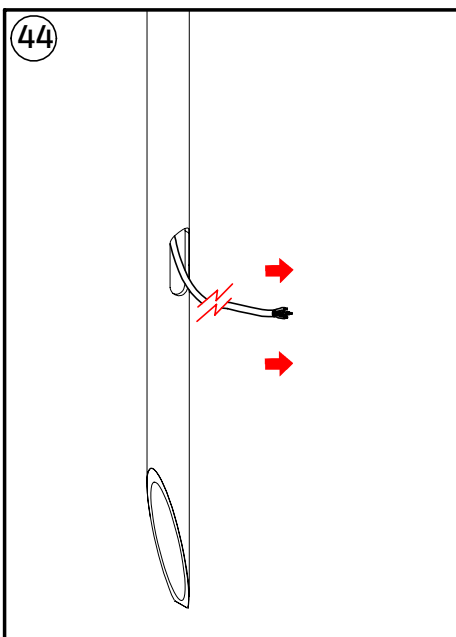
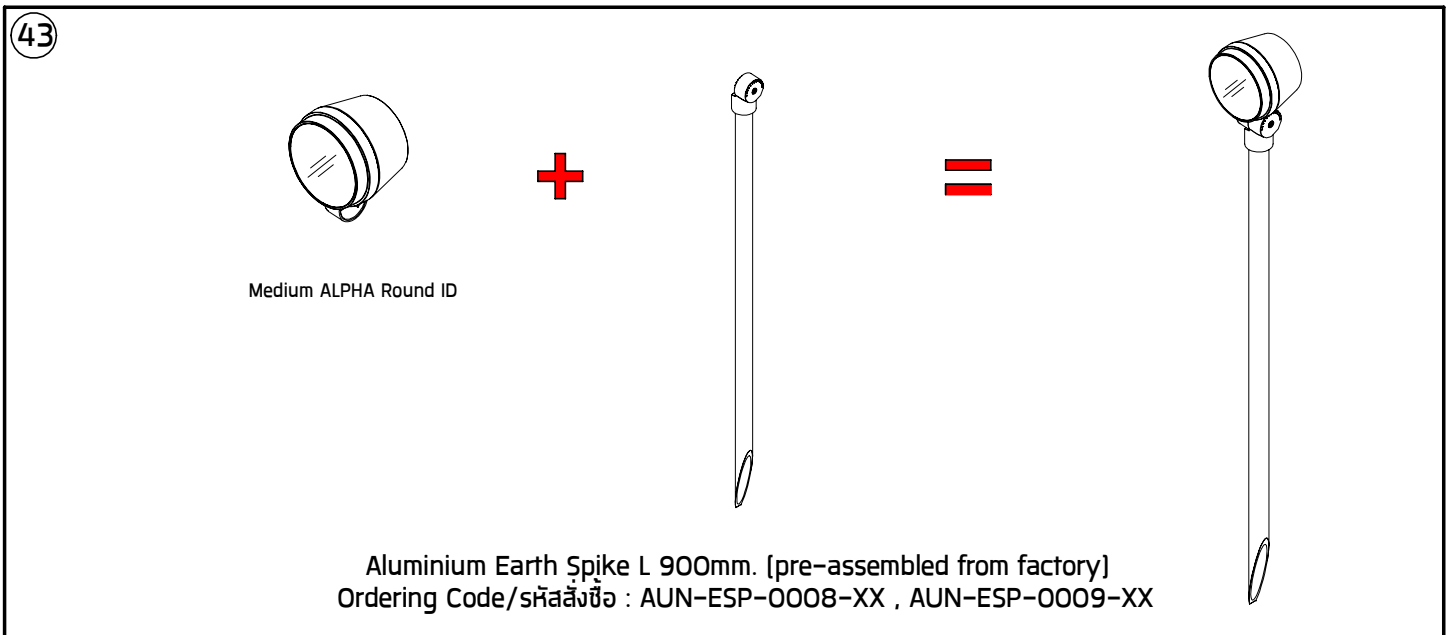
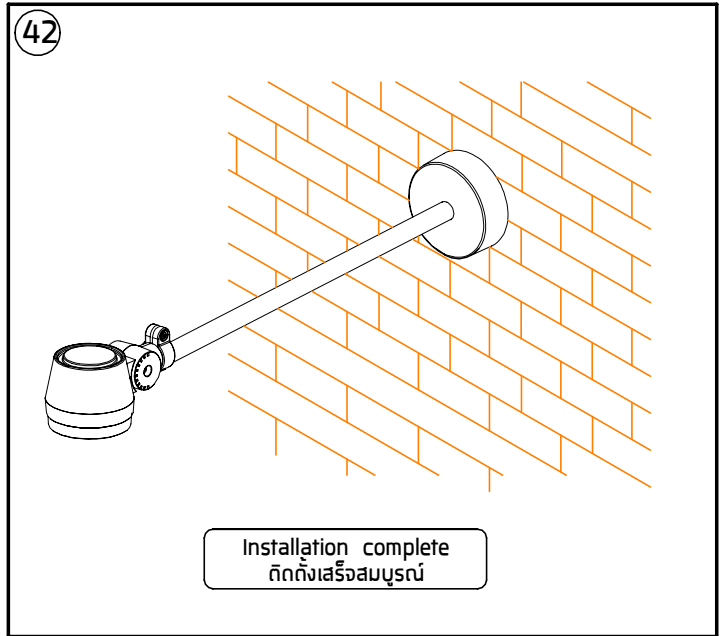
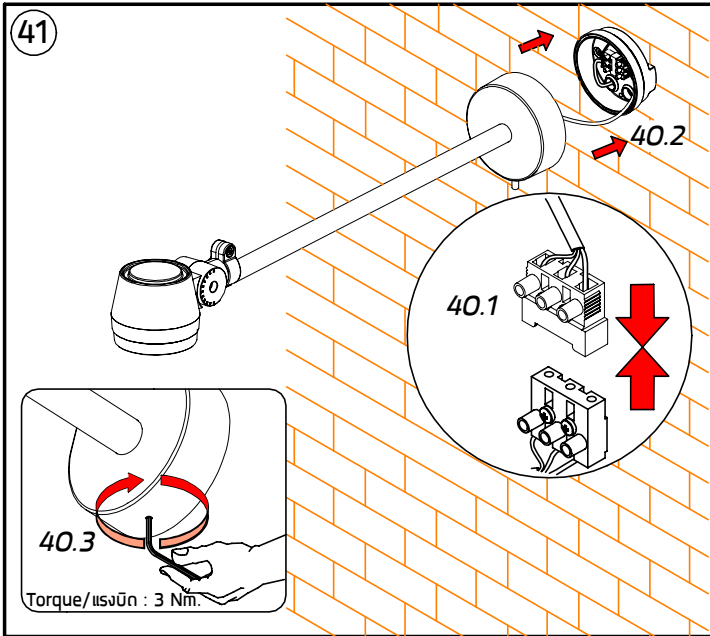

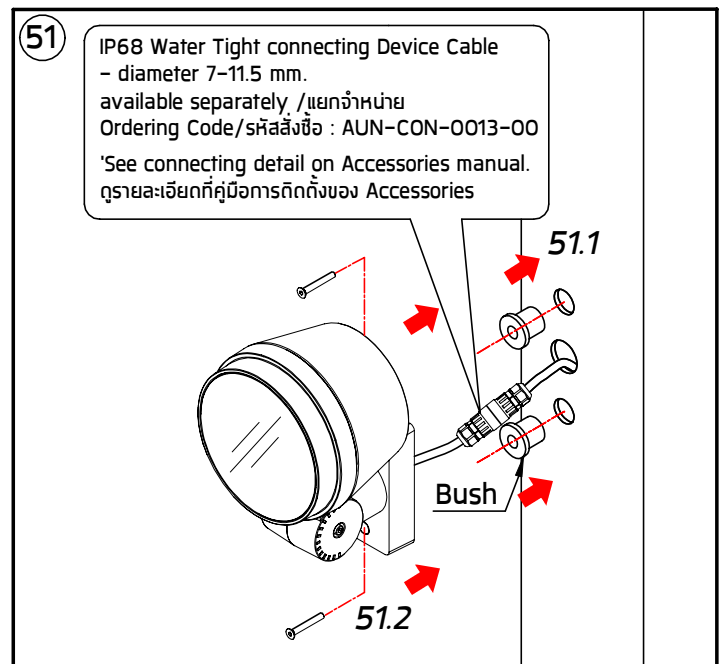
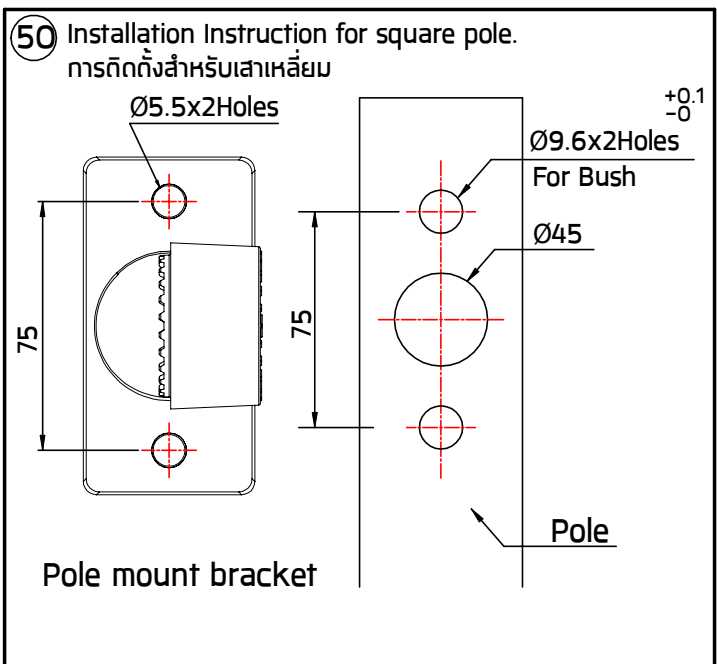
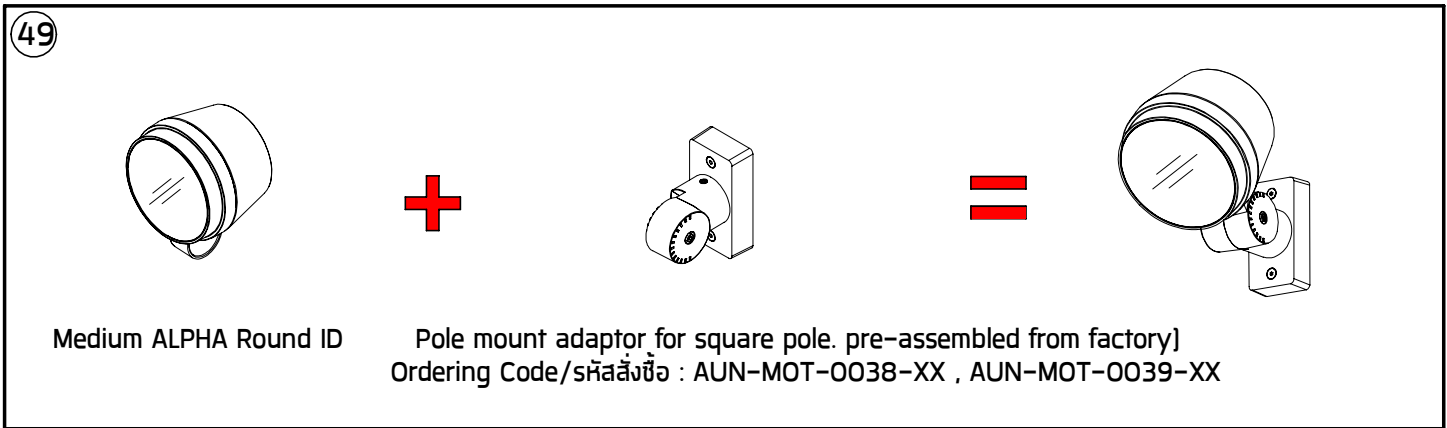
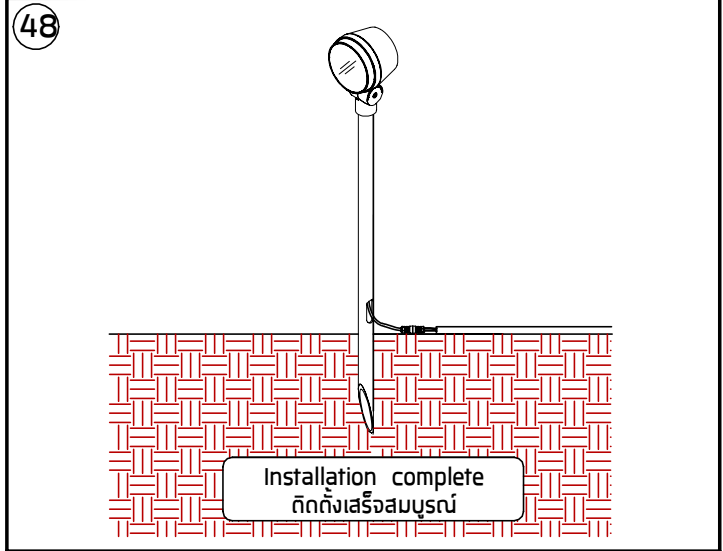
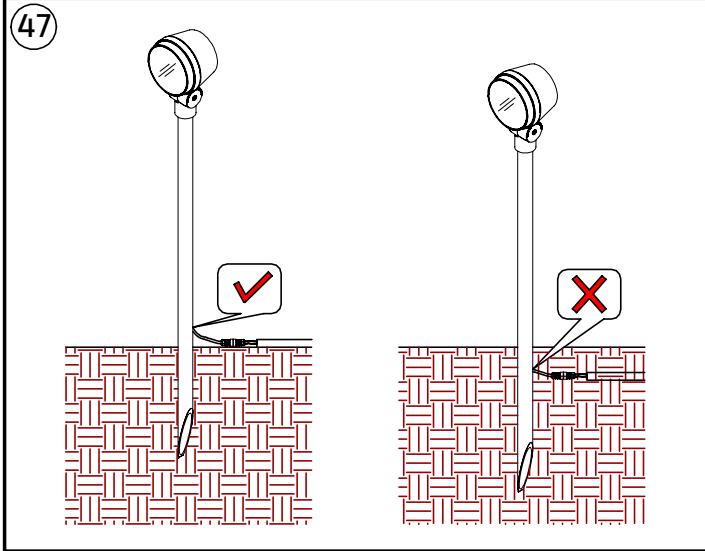

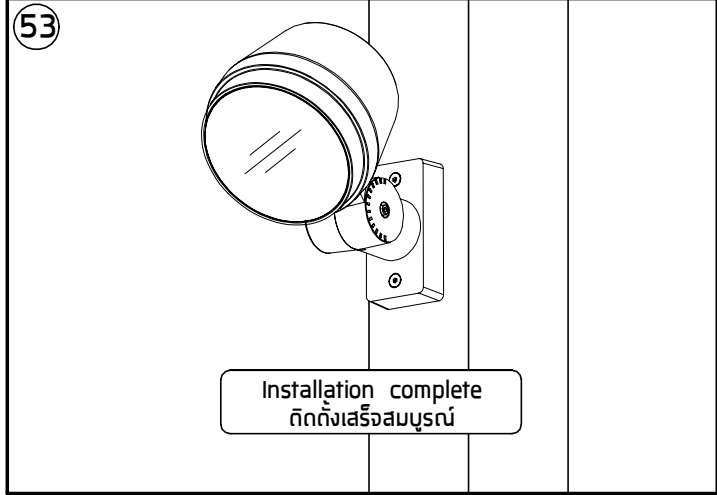
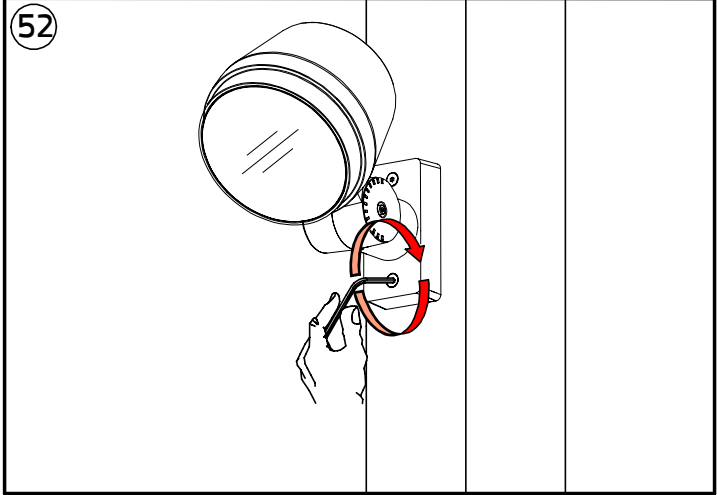

54

Medium ALPHA Round ID

No.	Accessory Name	Ordering Code
1.	Pole mount adaptor for pole dia 60mm. [On/Off]	AUN-MOT-0032-XX
2.	Pole mount adaptor for pole dia 76mm. [On/Off]	AUN-MOT-0034-XX
3.	Pole mount adaptor for pole dia 102-105mm. [On/Off]	AUN-MOT-0036-XX
4.	Pole mount adaptor for pole dia 60mm. [1-10V or DALI]	AUN-MOT-0033-XX
5.	Pole mount adaptor for pole dia 76mm. [1-10V or DALI]	AUN-MOT-0035-XX
6.	Pole mount adaptor for pole dia 102-105mm. [1-10V or DALI]	AUN-MOT-0037-XX

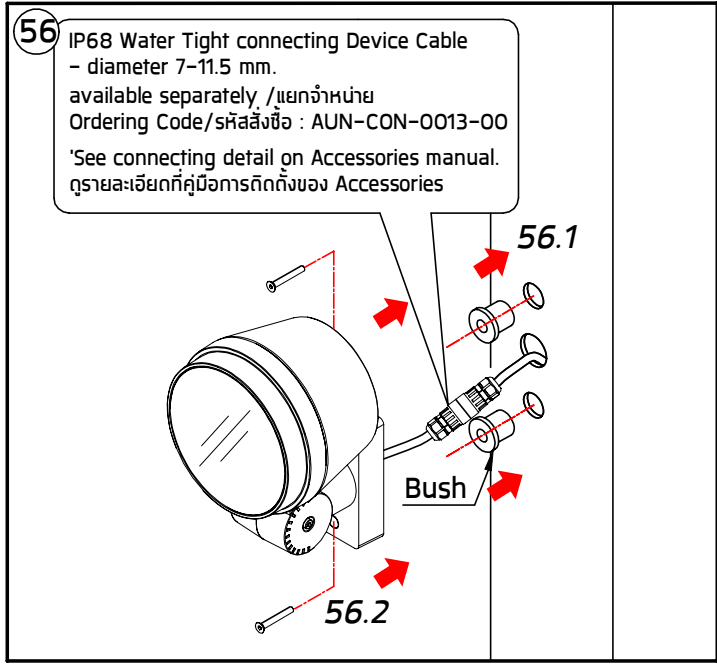
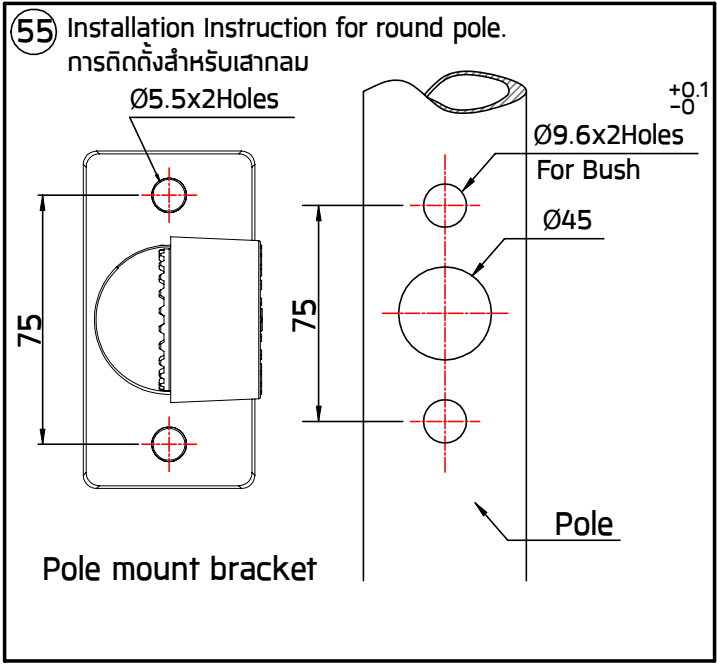

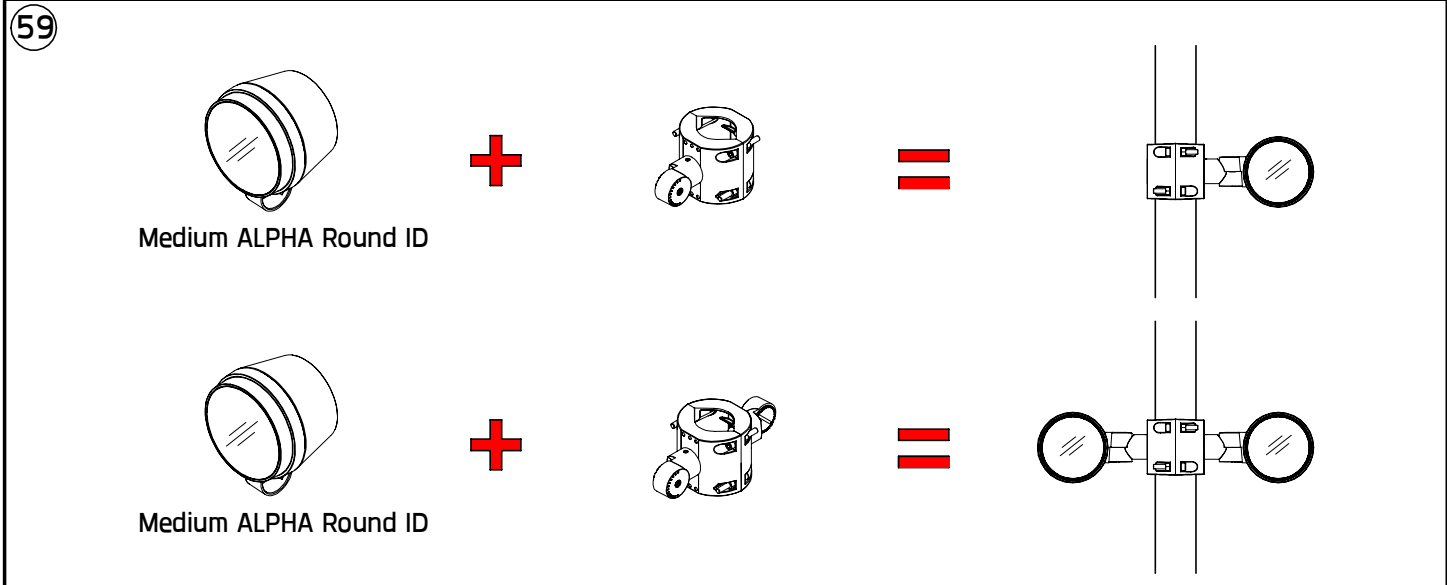
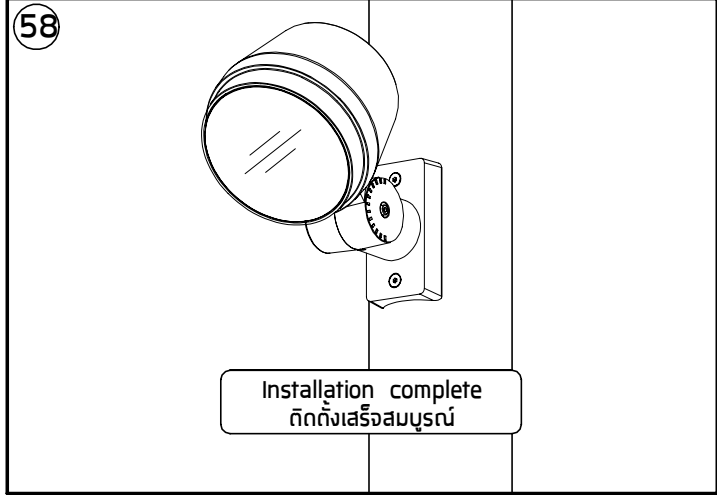
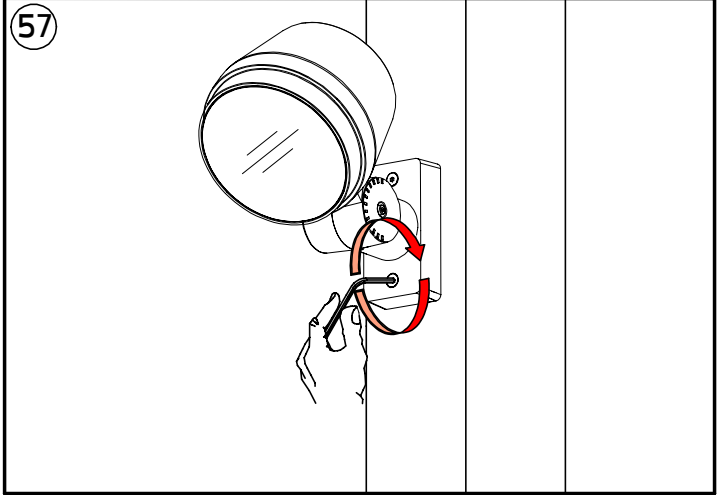

No.	Accessory Name	Ordering Code
1.	Pole Clamp Single Side Diameter 60-76mm. [On/Off]	AUN-CLP-0040-XX
2.	Pole Clamp Single Side Diameter 60-76mm. [DIM 1-10V , DALI]	AUN-CLP-0041-XX
3.	Pole Clamp Double Side Diameter 60-76mm. [On/Off]	AUN-CLP-0044-XX
4.	Pole Clamp Double Side Diameter 60-76mm. [DIM 1-10V , DALI]	AUN-CLP-0045-XX
5.	Pole Clamp Single Side Diameter 102-105mm. [On/Off]	AUN-CLP-0042-XX
6.	Pole Clamp Single Side Diameter 102-105mm. [DIM 1-10V , DALI]	AUN-CLP-0043-XX
7.	Pole Clamp Single Side Diameter 102-105mm. [On/Off]	AUN-CLP-0046-XX
8.	Pole Clamp Single Side Diameter 102-105mm. [DIM 1-10V , DALI]	AUN-CLP-0047-XX

60

IP68 Water Tight connecting Device Cable
- diameter 7-11.5 mm.
available separately / แยกจำหน่าย
Ordering Code/รหัสสั่งซื้อ : AUN-CLP-0047-XX
*See connecting detail on Accessories manual.
ดูรายละเอียดที่คู่มือการติดตั้งของ Accessories

60.1

61

Torque/แรงบิด : 2.5 Nm.

62

Installation complete
ติดตั้งเสร็จสมบูรณ์

63 For On-off System.
สำหรับระบบเปิด-ปิด

A = 24-25 mm.
B = 7-8 mm.
C = 19-20 mm.

Green/Yellow : ⊕
Brown : L
Blue : N

Cable Size/ขนาดสายไฟ : 3x1.00 mm² Ø7-11.5 mm.

IP68 Water Tight Connecting Device, 3 Pole, Cable Diameter 7-11.5mm.
ชุดข้อต่อสายไฟกันน้ำIP68, สำหรับสายไฟ 3สาย
Available Separately/แยกจำหน่ายต่างหาก
Ordering Code : AUN-CON-0013-00

64 For 1-10V dimming and DALI system.
สำหรับระบบทึบ1-10VและระบบDALI

A = 24-25 mm.
B = 7-8 mm.
C = 19-20 mm.

Green/Yellow : ⊕
Brown : L
Blue : N
White : + /DA1
Black : - /DA2

Cable Size/ขนาดสายไฟ : 5x1.00 mm² Ø8-12.5 mm.

IP68 water tight connecting device 5 Pole.Cable Diameter 8-12.5mm.
ชุดข้อต่อสายไฟกันน้ำIP68, สำหรับสายไฟ 5 สาย
Available Separately/แยกจำหน่ายต่างหาก
Ordering Code : AUN-CON-0014-00

65

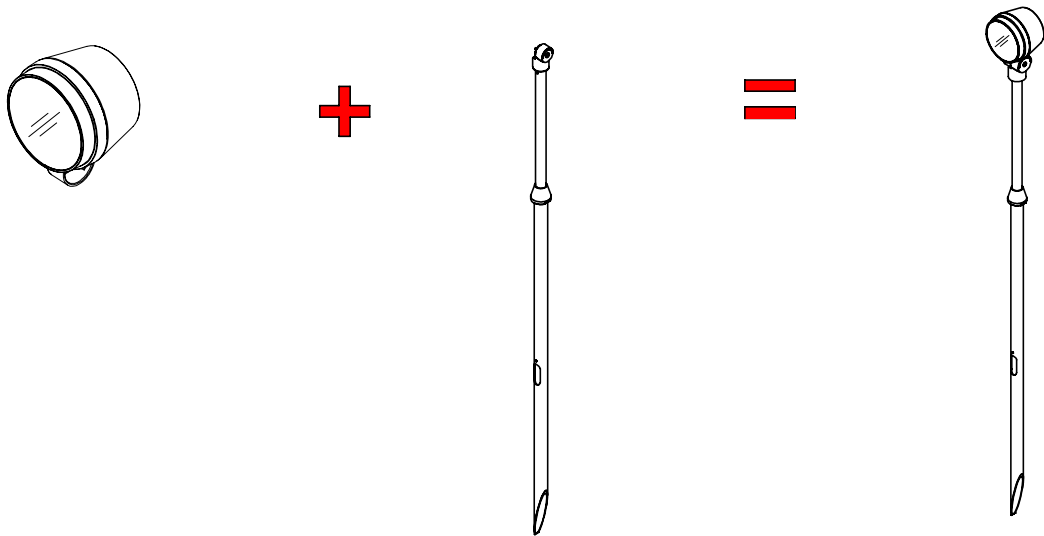

No.	Accessory Name	Ordering Code
1.	Adjustable Aluminium Earth Spike L 900-1300mm. [On/Off]	AUN-ESP-0023-XX
2.	Adjustable Aluminium Earth Spike L 900-1300mm. [1-10V or DALI]	AUN-ESP-0024-XX

66

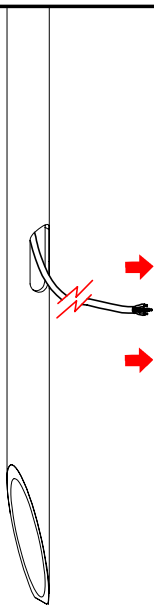

67

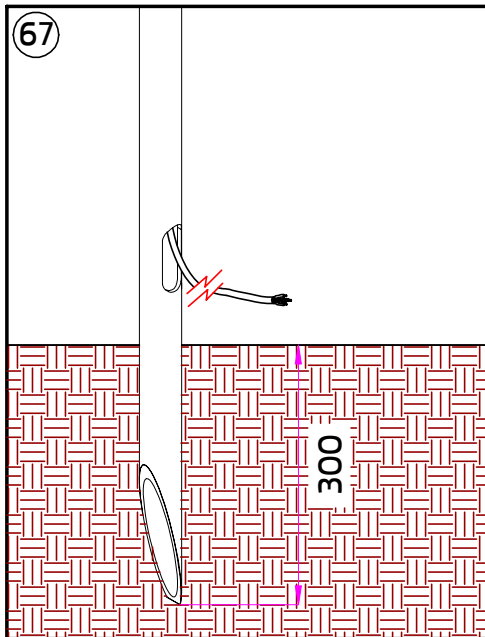

68

IP68 Water Tight connecting Device Cable
 - diameter 7-11.5 mm.
 available separately / แยกจำหน่าย
 Ordering Code/รหัสสั่งซื้อ : AUN-CON-0013-00
 *See connecting detail on Accessories manual.
 กรุณาระเบียบที่คู่มือการติดตั้งของ Accessories

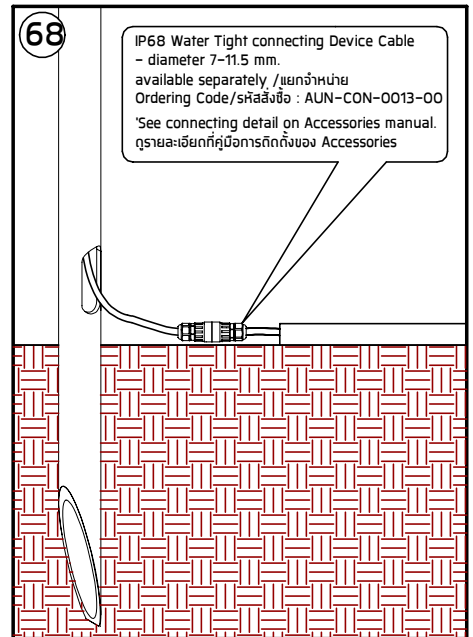

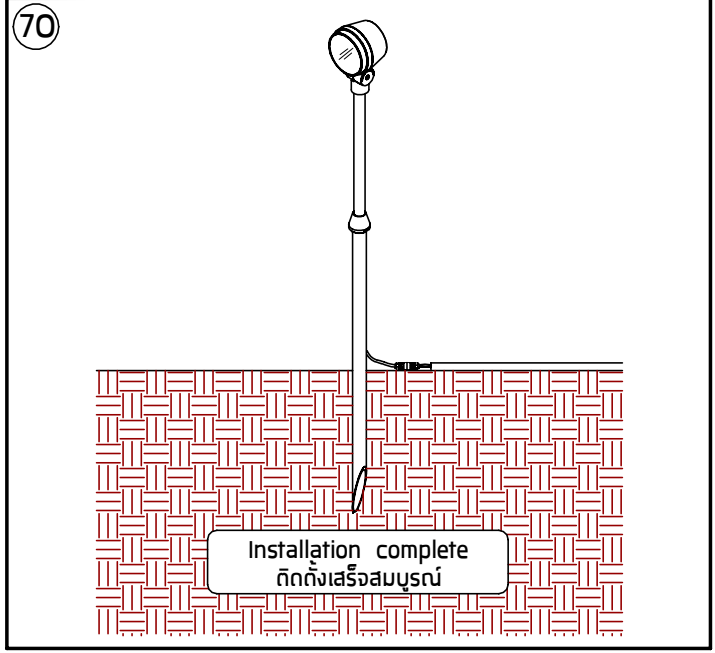
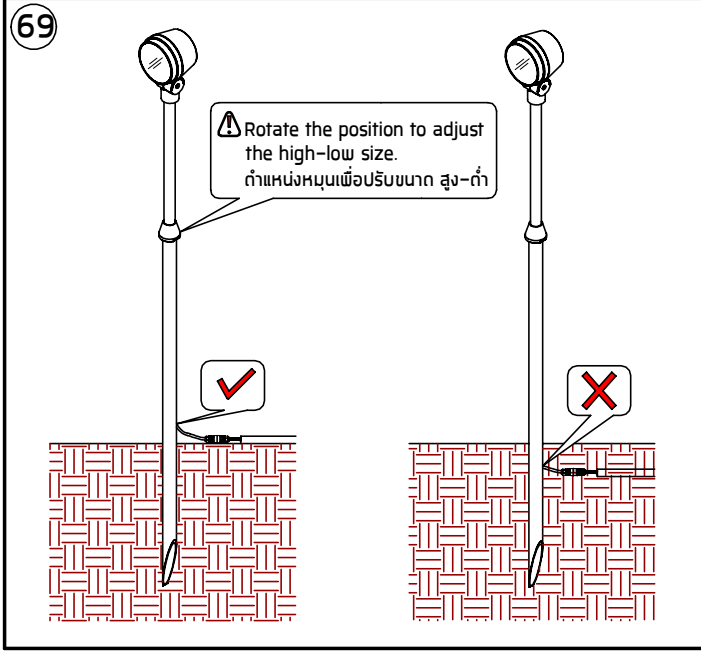

Remark :
หมายเหตุ

1. Installation should be carried out by a qualified electrician in accordance with appropriate national wiring regulation.
การติดตั้งโคมไฟและอุปกรณ์ ควรดำเนินการโดยช่างไฟฟ้าที่มีความรู้และความชำนาญ ในการติดตั้งอุปกรณ์ไฟฟ้า โดยเฉพาะตามมาตรฐานของการไฟฟ้า
2. Disconnect the power before changing the lamp.
ปิดสวิทช์ไฟทุกครั้งที่เปลี่ยนหลอดไฟ
3. This is Class1 luminaire, the installation must be completed with earthing.
โคมไฟรุ่นนี้ถูกจัดไว้ในประเภทของการป้องกันไฟฟ้ารั่ว ระดับ 1 ที่จะต้องต่อสายดินตามมาตรฐานความปลอดภัย
4. Do not exceed the maximum wattage.
ห้ามใช้หลอดไฟที่มีขนาดวัตต์เกินกว่าที่ระบุ หรือใช้หลอดไฟประเภท
5. Don't touch LED while maintaining or cleaning.
ห้ามสัมผัสหลอด LED ขณะบำรุงรักษา หรือทำความสะอาด

Warning :
ข้อควรระวัง

1. The manufacturer will not be liable or held responsible for any incorrect installation, misuse or improper use and unauthorised modification to the fittings. Failure to comply with mentioned warning may cause serious damage or serious injury to persons, animals or objects. If any modification is required please consult your dealer for the details.
ทางผู้ผลิตไม่สามารถรับผิดชอบในความเสียหายใดๆที่เกิดจากการติดตั้งไม่ถูกวิธี, ใช้งานผิดประเภทหรือดัดแปลงตัวโคม ในทุกกรณีซึ่ง สิ่งผิดปกติเหล่านี้ อาจทำให้เกิดอันตรายกับ คน สัตว์ สิ่งของ หากมีข้อสงสัยหรือมีความต้องการปรับแต่งตัวโคม ให้เหมาะสมกับการใช้งานกรุณาติดต่อตัวแทนจำหน่ายหรือผู้ผลิต
2. Where damage has occurred to the fittings, please make the replacement with standard parts before use.
ในกรณีที่มีส่วนประกอบใดเกิดความเสียหายกรุณาเปลี่ยนชิ้นส่วนใหม่ก่อนการใช้งานทุกครั้ง เพื่อความปลอดภัย

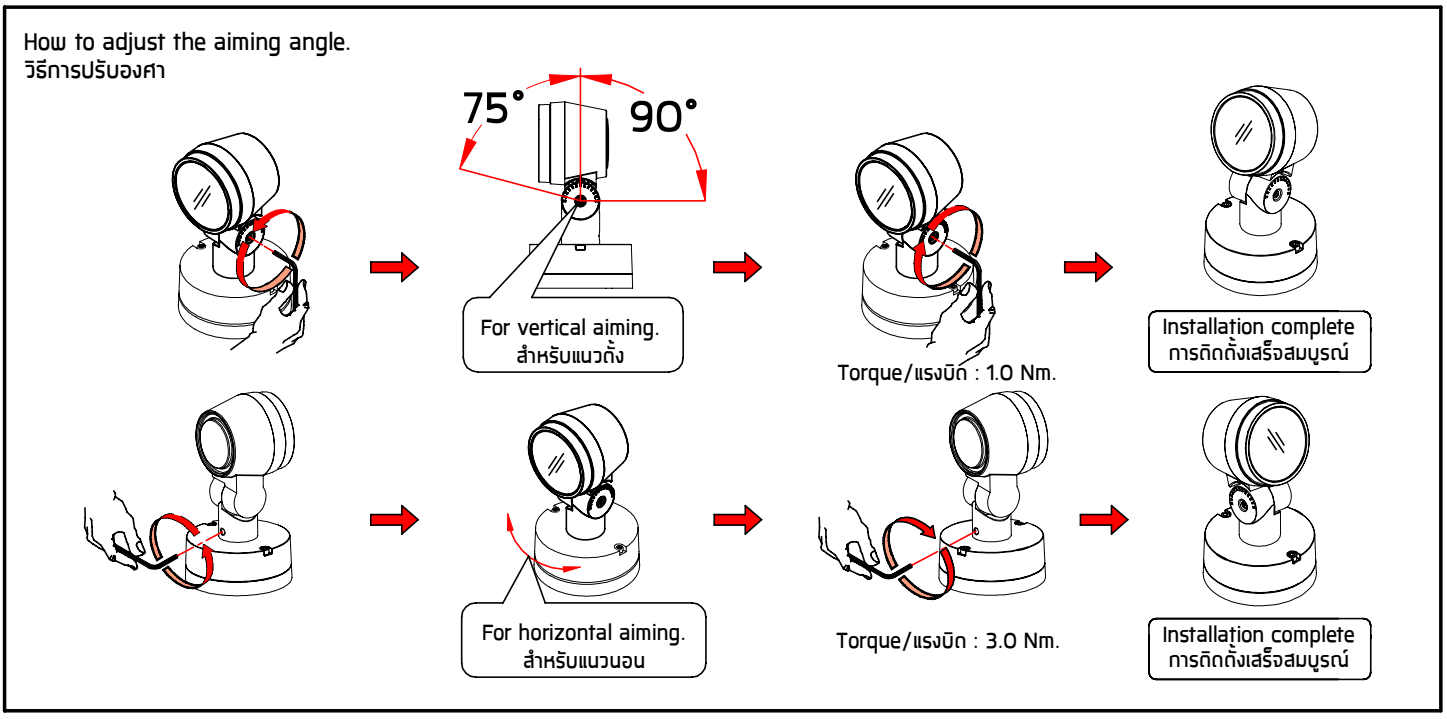

For On-Off system.
สำหรับระบบเปิด - ปิด

For 1-10V dimming and DALI system.
สำหรับระบบทึม1-10VและระบบDALI

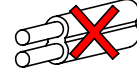

- Cable Size/ขนาดสายไฟ : 3x1.00 mm² Ø7-11.5mm.
- Cable Size/ขนาดสายไฟ : 5x1.00 mm² Ø8-12.5 mm.

In case the supply cable is exposed to sunlight use UV resistant cable.

กรณีที่มีการติดตั้งคอมไฟนอกรอาคาร หรือคอมไฟที่มีการแผ่รังสียูวี สายไฟต้องสามารถป้องกัน หรือ มีการป้องกันไม่ให้ถูกรังสียูวีได้

NO

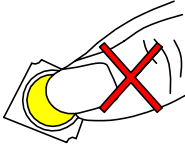

- Do not touch the LED because it may shorten the life time or the LED can be breaking down.
ห้ามสัมผัสหลอด LED โดยเด็ดขาด เพราะจะทำให้หลอดเสื่อมสภาพ

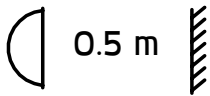

- Minimum distance to lighted surface.
ระยะห่างขั้นต่ำ จากหน้าคอมถึงพื้นผิวที่ถูกลูแสงสว่าง

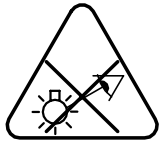

- The luminaire should be positioned so that prolonged staring into the luminaire at a distance closer than 0.5m is not expected.
ตำแหน่งที่ติดตั้งดวงคอมควรอยู่ในจุดที่แสงไม่ส่องเข้าดวงตาโดยตรงเป็นเวลานาน หากเข้าใกล้ในระยะน้อยกว่า 0.5 ม.

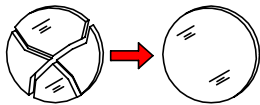

- Any damaged safety glass cover must be replaced only with the original spare part.
เมื่อกระจกเกิดความเสียหาย เพื่อความปลอดภัยควรสั่งอะไหล่แท้จากผู้ผลิตเท่านั้น

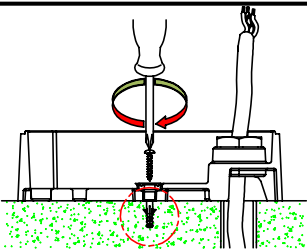

- Make sure the plug is secured tightly and note the ground level.
พุกต้องยึดอย่างแน่นหนาและเสมอกับพื้นผิว

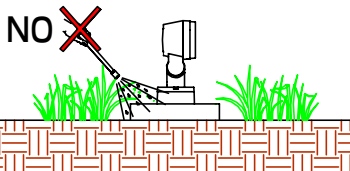
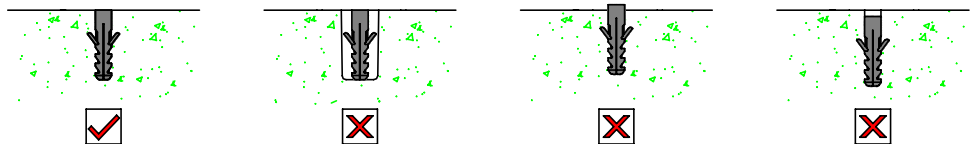

- Not using chemical compounds and aggressive agents such as , weed repellents fertilizers , acid solvent and contaminated irrigation water near the Luminaires.
ห้ามใช้สารเคมีเช่น ปุ๋ย, ยากำจัดศัตรูพืช, ปูนขาว, สารละลายที่เป็นกรด และน้ำปนเปื้อนสารเคมี บริเวณที่ติดตั้งคอมไฟ

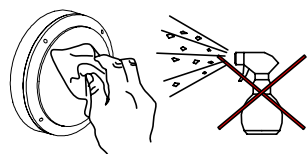

- Clean the products regularly to maintain good light output and prolong surface quality .
Only use solvent-free cleaning solutions on the products.
ทำความสะอาดผลิตภัณฑ์เป็นประจำเพื่อรักษาความส่องสว่างที่ดีและยืดอายุคุณภาพพื้นผิว
ใช้น้ำยาทำความสะอาดที่ไม่มีแอลกอฮอล์หรือตัวทำละลายกับผลิตภัณฑ์เท่านั้น

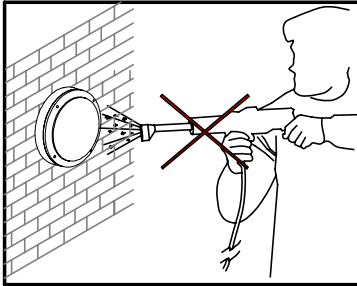

- Do not use a high pressure washer to clean the products.
ห้ามใช้เครื่องฉีดน้ำแรงดันสูงในการทำความสะอาดผลิตภัณฑ์

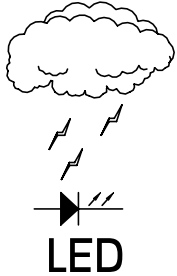

- Our products are installed with electronic components with the protection against overvoltage according to IEC 61547. The customers have to install the additional overvoltage protection devices (against surge, transients, etc) in their electrical system to avoid the risk of damage. Failing to do so will end the product warranty. ผลิตภัณฑ์ของเราได้มีการติดตั้งอุปกรณ์อิเล็กทรอนิกส์สำหรับการป้องกันแรงดันไฟเกินตามมาตรฐาน IEC 61547 และลูกค้าต้องติดตั้งอุปกรณ์ป้องกันแรงดันไฟเกินเพิ่มเติม (ป้องกันไฟกระชาก, ไฟฟ้าลัดวงจร ฯลฯ) ในระบบไฟฟ้าด้วย เพื่อหลีกเลี่ยงความเสี่ยงที่จะเกิดความเสียหาย หากไม่ดำเนินการดังกล่าว การรับประกันจะสิ้นสุดลง

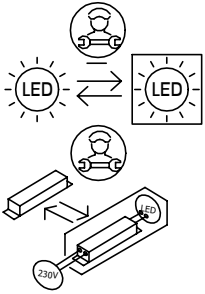

- To replace the LED module or the entire luminaire. Please consult your sales representative.
หากต้องการเปลี่ยน LED module หรือโคมไฟโปรดติดต่อตัวแทนขายของคุณ



- Environmental protection: Waste electrical products should not be disposed of with household waste. please recycle where facilities exist. check with your local authority or retailer for recycling advice According to directive 2002/96/CE and directive 2012/19/EU Waste Electrical and Electronic Equipment (WEEE). ห้ามทิ้งผลิตภัณฑ์นี้ร่วมกับขยะในครัวเรือนชนิดอื่นๆเมื่อสิ้นสุดอายุการใช้งานโปรดแยกผลิตภัณฑ์ออกจากของเสียประเภทอื่นๆและรีไซเคิลอย่างเหมาะสมเพื่อส่งเสริมการนำทรัพยากรกลับมาใช้ซ้ำซึ่งจะช่วยป้องกันอันตรายต่อสิ่งแวดล้อมหรือสุขภาพของมนุษย์ที่เกิดจากการทิ้งขยะโดยไม่มีการควบคุม อ้างอิงตามระเบียบ 2002/96/CE และระเบียบ 2012/19/EU Waste Electrical and Electronic Equipment (WEEE).

Replacing the LED module

วิธีการเปลี่ยน LED module

1. Contact your sales representative for replacement LED modules. Make sure that the replacement module match the initially supplied module. Note the part number printed on the LED module.
เตรียม LED module ให้ตรงกับรุ่นที่ต้องการเปลี่ยนโดยตรวจสอบที่หมายเลขที่พิมพ์บนLED modules และ ติดต่อกับตัวแทนขายเพื่อสั่งซื้อ LED modules ที่ต้องการเปลี่ยน
2. The LED module can be replaced by qualified persons using standard tools.
การเปลี่ยน LED module ต้องทำโดยช่างผู้ชำนาญและใช้เครื่องมือที่ได้มาตรฐาน
3. Disconnect power before opening the luminaire housing.
ตัดแหล่งจ่ายไฟก่อนที่จะเปิดตัวโคม
4. Replace the old LED module with the new LED module. Reapply thermal interface material as supplied with the new LED module.
ถอด LED module ที่ชำรุดออก จากนั้นทำความสะอาดจุดวางหลอด แล้วจึงทำการประกอบ LED module ใหม่ และต้องเปลี่ยน แผ่นThermal Pad หรือ Thermal Grease ด้วยทุกครั้ง
5. Inspect gaskets and if required replace with new gaskets. Defective luminaire covers must be replaced. Inspect correct wiring of replaced LED module.
ตรวจสอบปะเก็นและชิ้นส่วนของตัวโคม ถ้าชำรุดเสียหายให้ทำการเปลี่ยนใหม่ และตรวจสอบการเข้าสายไฟของ LED module ที่เปลี่ยนใหม่ถูกต้องหรือไม่
6. Close the luminaire housing before reconnecting power.
ปิดฝาครอบลือคโคมไฟให้เรียบร้อยก่อนเปิดไฟ