

## INSTALLATION MANUAL

PRODUCT NAME : Mounting arm for 1-3 Spotlights , Pole Clamp

No.	Accessories name	Ordering Code
1.	Mounting arm for 1-3 Spotlights	AUN-MOT-0013-XX
2.	Pole Clamp Diameter 102-105 mm. for mounting arm	AUN-CLP-0008-XX
3.	Pole Clamp Diameter 60-76 mm. for mounting arm	AUN-CLP-0009-XX

1

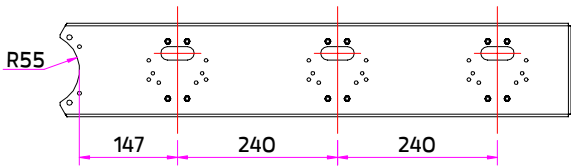
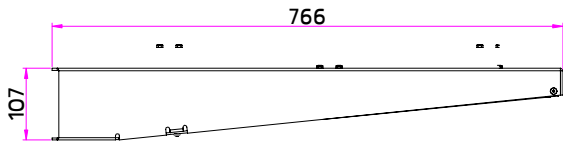
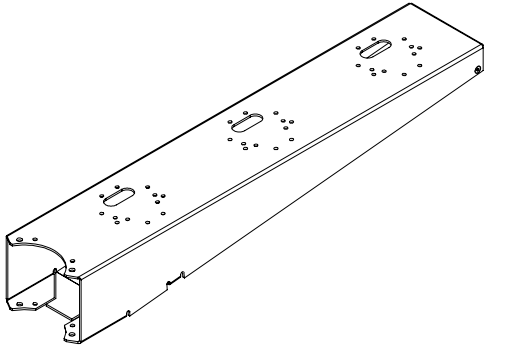

2

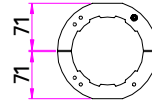
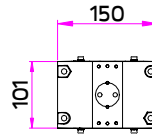
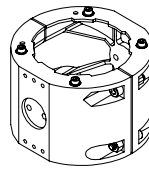

3

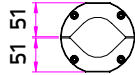
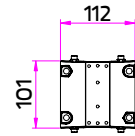
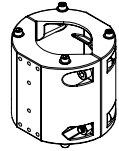

## 1 Sample Part ตัวอย่างชิ้นส่วน

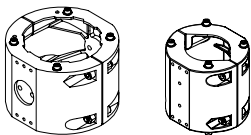

Part-A  
ชิ้น-A

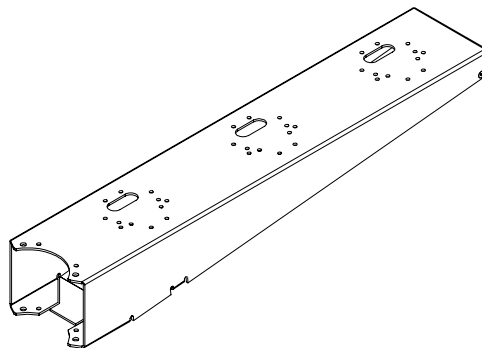

Part-B  
ชิ้น-B

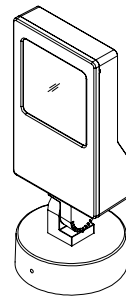

Part-C  
ชิ้น-C

2

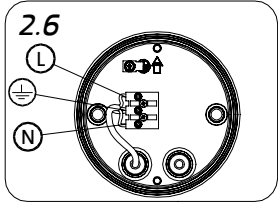
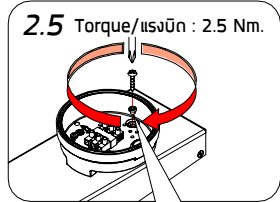
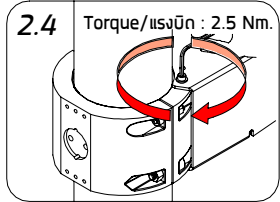
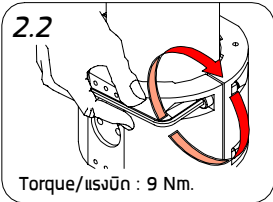

⚠ Bush protected against dripping water.  
 บุษป้องกันน้ำซึมเข้าตัวโคม

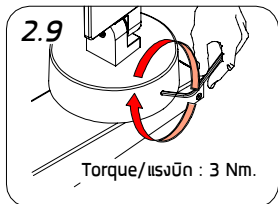
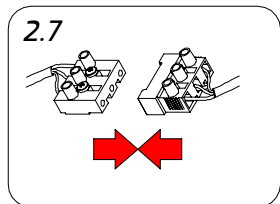
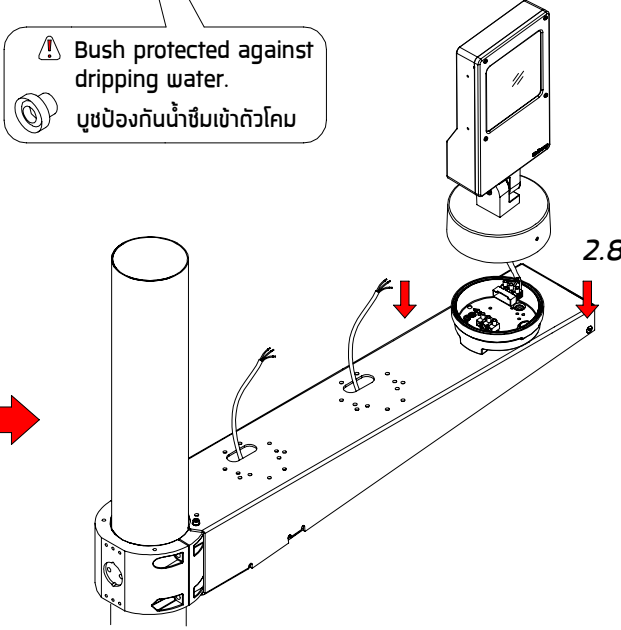
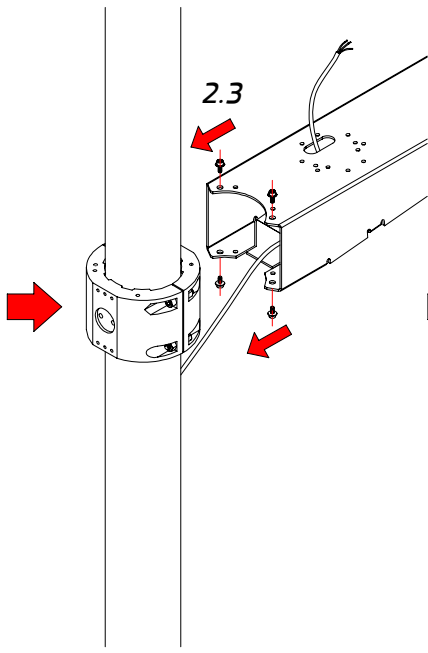
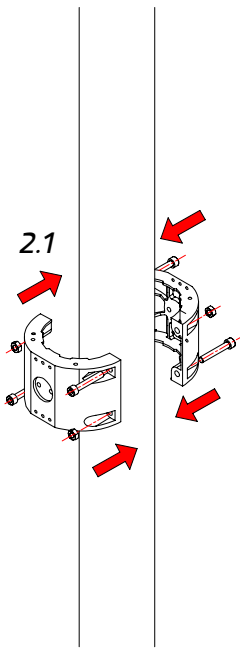

3

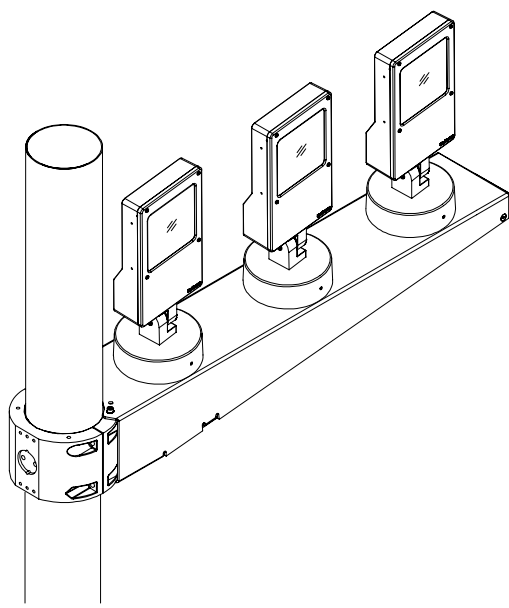

Installation complete  
 การติดตั้งเสร็จสมบูรณ์