

INSTALLATION MANUAL

PRODUCT NAME : Softening Filter for ATHLON

Item	Accessories Name	Ordering Code
1	Softening Filter	0290-0-9-000-000

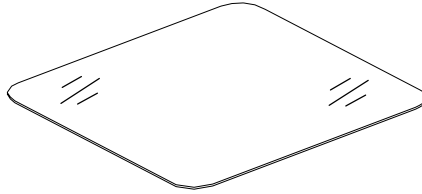

1

1

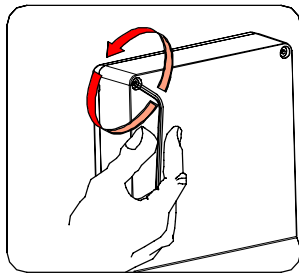
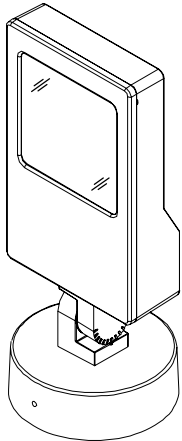

2

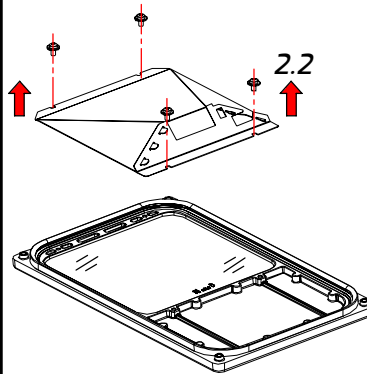

2.1

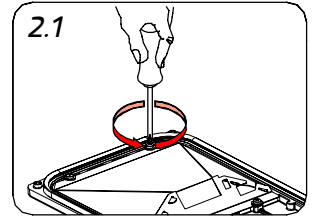

3

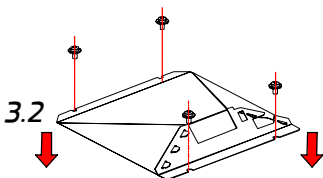

3.1

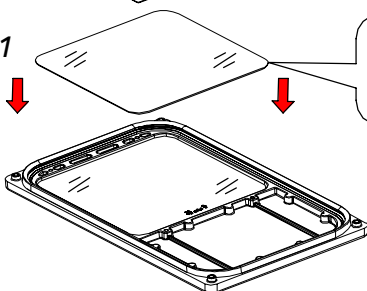

3.3

Torque : 0.5Nm.
แรงบิด

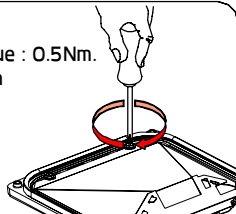

Softening Filter .
ซอฟเทนนิ่ง ฟิลเตอร์

4

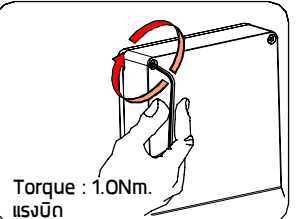
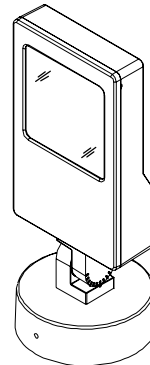

Torque : 1.0Nm.
แรงบิด

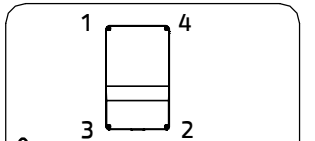

⚠ Lock the screws following this sequence.

ควรขันสกรูตามลำดับของหมายเลขที่ระบุไว้ตามรูปภาพ

Installation complete
การติดตั้งเสร็จสมบูรณ์