

SHOOTER

SHOOTER

ON-GROUND

 **Unilamp**

LAST UPDATE: 28-05-2024



SHOOTER is a rigid ground-surface uplighter made of a corrosion resistant LM6 aluminium housing passivated with Nano ceramic and double coated with super durable paint. SHOOTER is engineered from the beginning to be an ultra reliable IP67 luminaire and be able to withstand harmful impact. The LED used in this luminaire is produced by market leading manufacturer with the choices of three different color temperatures from 2700K, 3000K or 4000K in high color consistency and outstanding CRI. It is suitable for installation where a typical in-ground uplighter cannot be used or a cost effective solution is necessary. This luminaire is ideal for illumination of columns, panels, blocks, and plants.

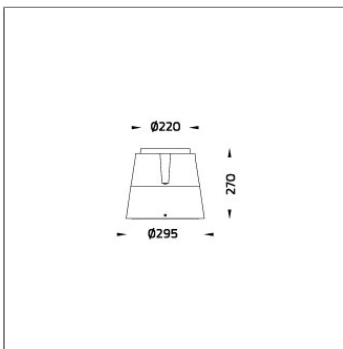

Technical Data



Ordering Code :	9900-7-3-874-XX
Lamp :	LED
Beam :	38°
CCT :	4000 K
CRI :	CRI >80
SDCM :	SDCM = 3
Lamp Lumen :	1900 lm
Luminaire Lumen :	1510 lm
Lamp Wattage :	20 W
Luminaire Wattage :	20 W
Efficacy :	75 lm/W
Ambient Temperature :	50°C
Lumen Maintenance	L70B50 >40,000 h
Controller :	On-Off (AC LED)
Input Voltage :	220-240Vac 50/60Hz
Net Weight :	7.20 kg.

Ordering code guide

XXXX-X-X-XXX-XX
A C E

- A Product Code
- B Reflector
- C Electrical Component
- D Lamp
- E Color



Icon definition

*Due to the constancy of product development, we reserve the right to alter all specification without prior notice.

Unilamp Co., Ltd.
461 Ramintra Road, Kannayao, Bangkok 10230 Thailand
Tel : +66(O)2 943 2420-1, +66(O)2 946 4170-1
Fax : +66(O)2 943 2419
online@unilamp.co.th
www.unilamp.co.th

SHOOTER

SHOOTER

ON-GROUND



LAST UPDATE: 28-05-2024

Specification

IEC Standard	IEC 60598-1 General Requirement IEC 60598-2-1 Fixed Luminaires												
Protection	IP67 Class I												
IK Rating	Protection against mechanical impact IK10 on body and optical part.												
Luminaires Body Housing	High-pressure die cast aluminum alloy body and components.												
Coating Process	Nano ceramic surface conversion, resistant to corrosive environment. Luminaire primarily coated with epoxy resin and top coated with UV stabilized polyester powder and cured in digital temperature controlled chamber at 200°C.												
Diffuser	Impact resistant safety tempered glass cover. Able to withstand the temperature up to 250°C.												
Reflector	High performance anodized spun aluminum reflector.												
Gasket	Post-cured treated silicone gasket. Temperature and weather resistant. Working temperature -40°C to +200°C.												
External Screws	External screws are in stainless steel with protection grease.												
Cable Entry	Cable entry protected by M20 cable gland. To be used with H05RN-F/ H07RN-F cable with 7-13mm. diameter.												
Led	High quality AC LED module. Conform to safety standard and electromagnetic compatibility standard.												
Internal Wire	Tinned copper conductor with silicone insulated internal wire. IMQ approved. Working temperature -40°C to +180°C.												
Terminal Block	Terminal block in GFR PA6.6 for cable with cross section up to 2.5 sqmm. VDE approved. Class1 luminaire provided with the earth connection.												
Pre-Wire Cable	Pre-wired with 3x1.0 sqmm. H07RN-F neoprene cable. IMQ approved.												
Caution	Installation work has to be carried on according to the enclosed installation manual.												
Color	<table><tr><td></td><td>Black O1</td></tr><tr><td></td><td>Graphite O2</td></tr><tr><td></td><td>Dark Grey O3</td></tr><tr><td></td><td>Aluminum Silver O4</td></tr><tr><td></td><td>White O6</td></tr><tr><td></td><td>Wooden Brown O7</td></tr></table>		Black O1		Graphite O2		Dark Grey O3		Aluminum Silver O4		White O6		Wooden Brown O7
	Black O1												
	Graphite O2												
	Dark Grey O3												
	Aluminum Silver O4												
	White O6												
	Wooden Brown O7												

Light Distribution

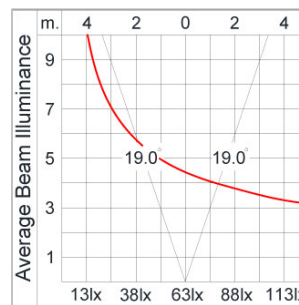
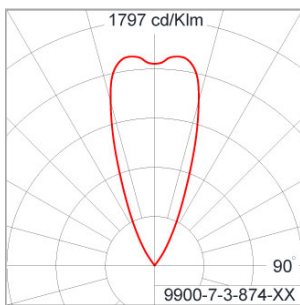

*Due to the constancy of product development,
we reserve the right to alter all specification
without prior notice.

Unilamp Co., Ltd.
461 Ramintra Road, Kannayao, Bangkok 10230 Thailand
Tel : +66(0)2 943 2420-1, +66(0)2 946 4170-1
Fax : +66(0)2 943 2419
online@unilamp.co.th
www.unilamp.co.th

SHOOTER

SHOOTER

ON-GROUND



LAST UPDATE: 28-05-2024

Accessories

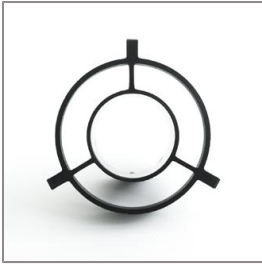

Ordering Code:
AUN-GHS-0016-00
Glare shield ring, COB

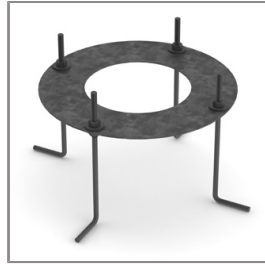

Ordering Code:
AUN-ACB-0004-00
Anchor bolt kit



Ordering Code:
AUN-CON-0003-00
IP68 Connector, cable
diameter 8-10mm,
gel-filled for through wiring

*Due to the constancy of product development,
we reserve the right to alter all specification
without prior notice.

Unilamp Co., Ltd.
461 Ramintra Road, Kannayao, Bangkok 10230 Thailand
Tel : +66[0]2 943 2420-1, +66[0]2 946 4170-1
Fax : +66[0]2 943 2419
online@unilamp.co.th
www.unilamp.co.th