

# SHOOTER

SHOOTER

ON-GROUND

 **Unilamp**

LAST UPDATE: 11-03-2025



SHOOTER is a rigid ground-surface uplighter made of a corrosion resistant LM6 aluminium housing passivated with Nano ceramic and double coated with super durable paint. SHOOTER is engineered from the beginning to be an ultra reliable IP67 luminaire and be able to withstand harmful impact. The LED used in this luminaire is produced by market leading manufacturer with the choices of three different color temperatures from 2700K, 3000K or 4000K in high color consistency and outstanding CRI. It is suitable for installation where a typical in-ground uplighter cannot be used or a cost effective solution is necessary. This luminaire is ideal for illumination of columns, panels, blocks, and plants.

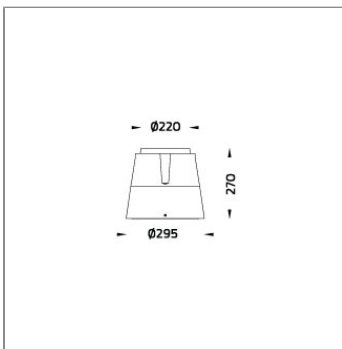

## Technical Data



|                       |                    |
|-----------------------|--------------------|
| Ordering Code :       | 9900-6-3-506-XX    |
| Lamp :                | LED                |
| Beam :                | 23°                |
| CCT :                 | 2700 K             |
| CRI :                 | CRI >80            |
| SDCM :                | SDCM = 3           |
| Lamp Lumen :          | 3160 lm            |
| Luminaire Lumen :     | 3050 lm            |
| Lamp Wattage :        | 23 W               |
| Luminaire Wattage :   | 27 W               |
| Efficacy :            | 112 lm/W           |
| Ambient Temperature : | 50°C               |
| Lumen Maintenance     | L70B10 >90,000 h   |
| Controller :          | On-Off             |
| Input Voltage :       | 220-240Vac 50/60Hz |
| Net Weight :          | 1.50 kg.           |

### Ordering code guide

XXXX-X-X-XXX-XX  
A C E

- A Product Code
- B Reflector
- C Electrical Component
- D Lamp
- E Color



Icon definition

\*Due to the constancy of product development, we reserve the right to alter all specification without prior notice.

Unilamp Co., Ltd.  
461 Ramintra Road, Kannayao, Bangkok 10230 Thailand  
Tel : +66(O)2 943 2420-1, +66(O)2 946 4170-1  
Fax : +66(O)2 943 2419  
online@unilamp.co.th  
www.unilamp.co.th

# SHOOTER

## SHOOTER

### ON-GROUND



LAST UPDATE: 11-03-2025

#### Specification

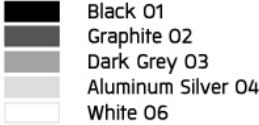
|                         |   |
|-------------------------|---|
| IEC Standard            | IEC 60598-1 General Requirement<br>IEC 60598-2-1 Fixed Luminaires   |
| Protection              | IP67 Class I  |
| IK Rating               | Protection against mechanical impact IK10 on body and optical part.   |
| Luminaires Body Housing | High-pressure die cast aluminum alloy body and components.  |
| Coating Process         | Nano ceramic surface conversion, resistant to corrosive environment. Luminaire primarily coated with epoxy resin and top coated with UV stabilized polyester powder and cured in digital temperature controlled chamber at 200°C. |
| Diffuser                | Impact resistant safety tempered glass cover. Able to withstand the temperature up to 250°C.  |
| Reflector               | High performance anodized spun aluminum reflector.  |
| Gasket                  | Post-cured treated silicone gasket. Temperature and weather resistant. Working temperature -40°C to +200°C.   |
| External Screws         | External screws are in stainless steel with protection grease.  |
| Cable Entry             | Cable entry protected by M20 cable gland. To be used with H05RN-F/ H07RN-F cable with 7-13mm. diameter.   |
| Led                     | High efficiency LED module in COB technology. Assembled on MCPCB and mounted on to heat conductive material.  |
| Driver                  | High quality constant current LED driver. Conform to safety standard and electromagnetic compatibility standard.  |
| Internal Wire           | Tinned copper conductor with silicone insulated internal wire. IMQ approved. Working temperature -40°C to +180°C.   |
| Terminal Block          | Terminal block in GFR PA6.6 for cable with cross section up to 2.5 sqmm. VDE approved.<br>Class1 luminaire provided with the earth connection.  |
| Pre-Wire Cable          | Pre-wired with 3x1.0 sqmm. H07RN-F neoprene cable. IMQ approved.  |
| Caution                 | Installation work has to be carried on according to the enclosed installation manual.   |
| Color                   | <br>Black O1<br>Graphite O2<br>Dark Grey O3<br>Aluminum Silver O4<br>White O6  |

#### Light Distribution

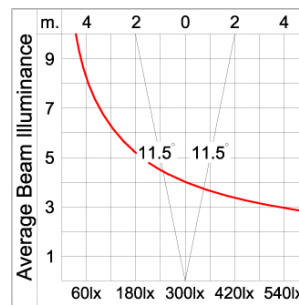
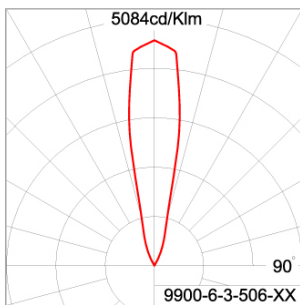

\*Due to the constancy of product development, we reserve the right to alter all specification without prior notice.

Unilamp Co., Ltd.  
461 Ramintra Road, Kannayao, Bangkok 10230 Thailand  
Tel : +66(0)2 943 2420-1, +66(0)2 946 4170-1  
Fax : +66(0)2 943 2419  
online@unilamp.co.th  
www.unilamp.co.th

# SHOOTER

SHOOTER

ON-GROUND

 **Unilamp**

LAST UPDATE: 11-03-2025

## Accessories



Ordering Code:  
AUN-GHS-0025-00  
Glare shield ring, COB

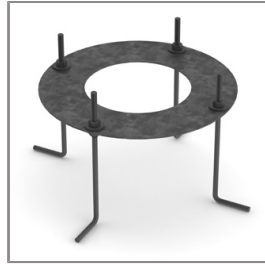

Ordering Code:  
AUN-ACB-0004-00  
Anchor bolt kit



Ordering Code:  
AUN-CON-0003-00  
IP68 Connector, cable  
diameter 8-10mm,  
gel-filled for through wiring

\*Due to the constancy of product development,  
we reserve the right to alter all specification  
without prior notice.

Unilamp Co., Ltd.  
461 Ramintra Road, Kannayao, Bangkok 10230 Thailand  
Tel : +66[0]2 943 2420-1, +66[0]2 946 4170-1  
Fax : +66[0]2 943 2419  
online@unilamp.co.th  
www.unilamp.co.th