

AYERS is a family of ground washer luminaires designed to deliver low-glare, multi-directional illumination across outdoor environments. Available in three sizes—AYERS, Mini AYERS, and the new Micro AYERS—this range offers flexibility for a variety of lighting applications, from large open spaces to compact architectural details. The main and mini versions feature high-strength aluminum housings paired with GFR polymer recessed components for long-term durability in harsh conditions. Their high-efficiency COB LED modules and precision optical reflectors ensure powerful lumen output with sharp light distribution. Micro AYERS, the most compact member of the family, is crafted from corrosion-resistant stainless steel and designed with a robust recessed housing, making it an ideal choice for discreet outdoor illumination. It preserves the refined aesthetics and dependable performance that characterize the AYERS range. Each fixture is sealed with a post-cured silicone gasket for superior watertight protection and comes pre-wired for easy installation. With its blend of design, performance, and robust construction, the AYERS family is a dependable choice for lighting pathways, plazas, and architectural surfaces.

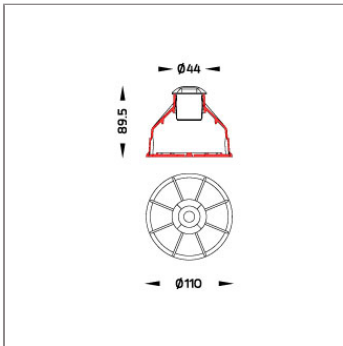

Technical Data



Ordering Code :	9112-0-J-056-91
Lamp :	LED
CCT :	3000 K
CRI :	CRI >80
SDCM :	SDCM = 5
Lamp Lumen :	150 lm
Luminaire Lumen :	65 lm
Lamp Wattage :	3 W[24Vdc]
Luminaire Wattage :	3 W
Efficacy :	21 lm/W
Ambient Temperature :	40°C
Lumen Maintenance	L90B10 >54,400 h
Controller :	Remote
Input Voltage :	24Vdc
Net Weight :	- kg.

Ordering code guide

XXXX-X-X-XXX-XX

B
D

A
C
E

- A Product Code
- B Reflector
- C Electrical Component
- D Lamp
- E Color



Icon definition

Specification

IEC Standard	IEC 60598-1 General Requirement IEC 60598-2-13 Ground Recessed Luminaires
Protection	IP68 Class III
IK Rating	Protection against mechanical impact IK10
Luminaires Body Housing	Superior corrosion-proof stainless steel. Recessed housing made from impact-resistant GFR polymer for durability. Engineered for high durability with a 1000 kg static load capacity.
Diffuser	Advanced clear polycarbonate diffuser with UV and flame resistance.
Led	Premium LED module with top-tier chips, mounted on MCPCB for heat efficiency.
Driver	Driver not included, must be purchased separately.
Internal Wire	Reliable silicone-insulated tinned copper internal wire, designed for -40°C to +180°C.
Pre-Wire Cable	Certified pre-wired 2x0.4 sqmm cable, featuring HO5RN-F neoprene insulation.
Caution	Installation must be performed as per the provided installation instructions. Confirm water drainage system effectiveness before installation.

Light Distribution

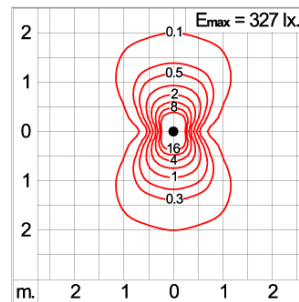
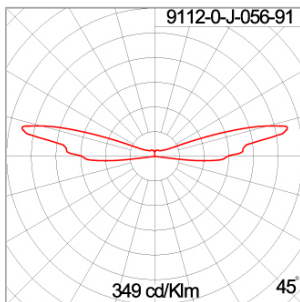

Accessories

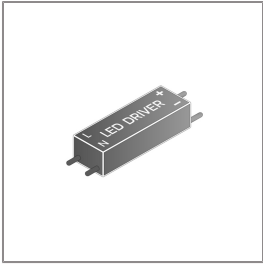

Ordering Code:
AUN-DRG-0011-00
LED constant voltage
driver, 24VDC, 150W



Ordering Code:
AUN-CON-0024-00
IP68 Connector, cable
diameter 4.8-6mm,
gel-filled

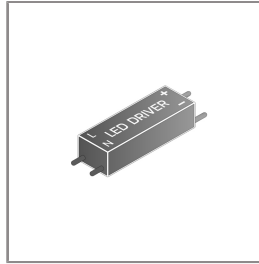

Ordering Code:
AUN-DRG-0024-00
LED constant voltage
driver, 24VDC, 200W

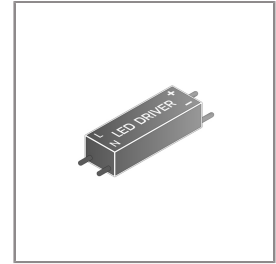

Ordering Code:
AUN-DRG-0027-00
LED constant voltage
driver, 24VDC, 72W

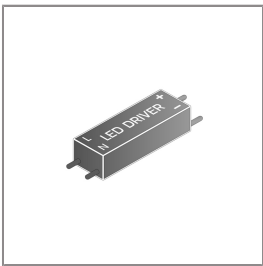

Ordering Code:
AUN-DRG-0118-00
LED constant voltage
driver, 24VDC, 30W