

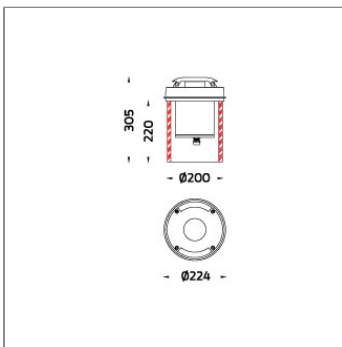

AYERS is a family of ground washer luminaires designed to deliver low-glare, multi-directional illumination across outdoor environments. Available in three sizes—AYERS, Mini AYERS, and the new Micro AYERS—this range offers flexibility for a variety of lighting applications, from large open spaces to compact architectural details. The main and mini versions feature high-strength aluminum housings paired with GFR polymer recessed components for long-term durability in harsh conditions. Their high-efficiency COB LED modules and precision optical reflectors ensure powerful lumen output with sharp light distribution. Micro AYERS, the most compact member of the family, is crafted from corrosion-resistant stainless steel and designed with a robust recessed housing, making it an ideal choice for discreet outdoor illumination. It preserves the refined aesthetics and dependable performance that characterize the AYERS range. Each fixture is sealed with a post-cured silicone gasket for superior watertight protection and comes pre-wired for easy installation. With its blend of design, performance, and robust construction, the AYERS family is a dependable choice for lighting pathways, plazas, and architectural surfaces.



Technical Data



Ordering Code :	9105-0-3-905-XX
Lamp :	LED
CCT :	4000 K
CRI :	CRI >80
SDCM :	SDCM = 3
Lamp Lumen :	2470 lm
Luminaire Lumen :	200 lm
Lamp Wattage :	16 W
Luminaire Wattage :	19 W
Efficacy :	10 lm/W
Ambient Temperature :	40°C
Lumen Maintenance	L70B10 >90,000 h
Controller :	On-Off
Input Voltage :	220-240Vac 50/60Hz
Net Weight :	7.80 kg.

Ordering code guide

XXXX-X-X-XXX-XX

B
D

A
C
E

- A Product Code
- B Reflector
- C Electrical Component
- D Lamp
- E Color



Icon definition

Specification

IEC Standard	IEC 60598-1 General Requirement IEC 60598-2-13 Ground Recessed Luminaires										
Protection	IP67 Class I										
IK Rating	Protection against mechanical impact IK10 on body and optical part.										
Luminaires Body Housing	High strength cast aluminum alloy component. Extruded aluminum 56063 alloy body with low copper content. Recessed housing made of GFR polymer. Luminaire withstands a maximum static load of 1000 kg.										
Coating Process	Nano Ceramic surface conversion, resistant to corrosive environment. Luminaire primarily coated with epoxy resin and top coated with UV stabilized polyester powder and cured in digital temperature controlled chamber at 200°C.										
Diffuser	Safety pressed glass cover from Germany.										
Reflector	High performance metallized reflector.										
Gasket	Post-cured treated silicone gasket. Temperature and weather resistant. Working temperature -40°C to +200°C.										
External Screws	External screws are in stainless steel with protection grease.										
Cable Entry	Cable entry protected by M20 cable gland. To be used with H05RN-F/ H07RN-F cable with 7-13mm. diameter.										
Led	High efficiency LED module in COB technology. Assembled on MCPCB and mounted on to heat conductive material.										
Driver	High quality constant current LED driver. Conform to safety standard and electromagnetic compatibility standard.										
Internal Wire	Tinned copper conductor with silicone insulated internal wire. IMQ approved. Working temperature -40°C to +180°C.										
Terminal Block	Terminal block in GFR PA6.6 for cable with cross section up to 2.5 sqmm. VDE approved. Class1 luminaire provided with the earth connection.										
Pre-Wire Cable	Pre-wired with 3x1.0 sqmm. H07RN-F neoprene cable. IMQ approved.										
Caution	Installation work has to be carried on according to the enclosed installation manual. The water drainage system must be tested to ensure that it is working sufficiency and efficiency.										
Color	<table border="0"> <tr> <td></td> <td>Black O1</td> </tr> <tr> <td></td> <td>Graphite O2</td> </tr> <tr> <td></td> <td>Dark Grey O3</td> </tr> <tr> <td></td> <td>Aluminum Silver O4</td> </tr> <tr> <td></td> <td>White O6</td> </tr> </table>		Black O1		Graphite O2		Dark Grey O3		Aluminum Silver O4		White O6
	Black O1										
	Graphite O2										
	Dark Grey O3										
	Aluminum Silver O4										
	White O6										

Light Distribution

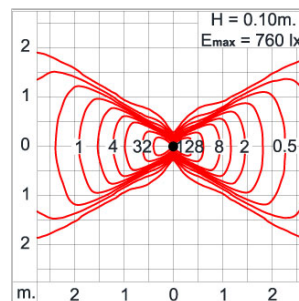
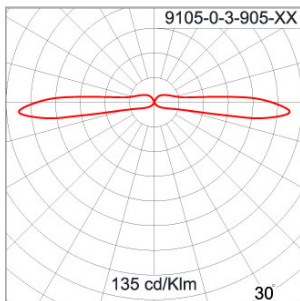

Accessories



Ordering Code:
AUN-CON-0013-00
IP68 connection device,
cable diameter 7-11.5mm,
On-Off



Ordering Code:
AUN-CON-0004-00
IP68 Connector, cable
diameter 8-10mm,
gel-filled



Ordering Code:
AUN-CON-0003-00
IP68 Connector, cable
diameter 8-10mm,
gel-filled for through wiring