

GRAVITON

GRAVITON SQUARE IN-GROUND UPLIGHTER INGROUND



LAST UPDATE: 15-05-2024



GRAVITON is designed for all kind of uplight illumination tasks where high level of illumination is needed. It is able to withstand loads up to 1000KG. The luminaire is fitted with a pre-wired supply cable for in-ground application and internally potted to prevent humidity and condensation. GRAVITON is available with COB LED light source with choices of beam and color temperature. It can be used to illuminate plants, flagpoles, columns, building facades and other architectural works. We highly recommend that the luminaire lay out should be considered during specifying and planning processes.

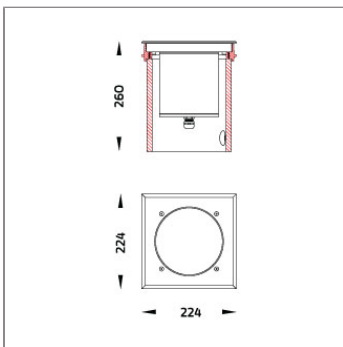

Technical Data



Ordering Code :	9092-5-4-506-91
Lamp :	LED
Beam :	12°
CCT :	2700 K
CRI :	CRI >80
SDCM :	SDCM = 3
Lamp Lumen :	2300 lm
Luminaire Lumen :	2300 lm
Lamp Wattage :	16 W
Luminaire Wattage :	19 W
Efficacy :	121 lm/W
Ambient Temperature :	35°C
Lumen Maintenance	L70B10 >90,000 h
Controller :	DIM 1-10V
Input Voltage :	220-240Vac 50/60Hz
Net Weight :	- kg.

Ordering code guide

XXXX-X-X-XXX-XX
A B C D E

- A Product Code
- B Reflector
- C Electrical Component
- D Lamp
- E Color



Icon definition

*Due to the constancy of product development, we reserve the right to alter all specification without prior notice.

Unilamp Co., Ltd.
461 Ramintra Road, Kannayao, Bangkok 10230 Thailand
Tel : +66(O)2 943 2420-1, +66(O)2 946 4170-1
Fax : +66(O)2 943 2419
online@unilamp.co.th
www.unilamp.co.th

GRAVITON

GRAVITON SQUARE IN-GROUND UPLIGHTER INGROUND



LAST UPDATE: 15-05-2024

Specification

IEC Standard	IEC 60598-1 General Requirement IEC 60598-2-13 Ground Recessed Luminaires
Protection	IP67 Class I
IK Rating	Protection against mechanical impact IK10 on body and optical part.
Luminaires Body Housing	Front cover in 316 stainless steel brush finished. Extruded aluminum 6063 alloy body with low copper content. Recessed housing made of GFR polymer. Luminaire withstands a maximum static load of 2000 kg.
Coating Process	Nano Ceramic surface conversion, resistant to corrosive environment. Luminaire primarily coated with epoxy resin and top coated with UV stabilized polyester powder and cured in digital temperature controlled chamber at 200°C.
Diffuser	Impact resistant safety tempered glass cover. Able to withstand the temperature up to 250°C. Glass flushes to the front cover, no accumulation of dust and water.
Reflector	High performance anodized spun aluminum reflector.
Gasket	Post-cured treated silicone gasket. Temperature and weather resistant. Working temperature -40°C to +200°C.
External Screws	External screws are in stainless steel with protection grease.
Cable Entry	Cable entry protected by M20 cable gland. To be used with H05RN-F/ H07RN-F cable with 7-13mm. diameter.
Led	High efficiency LED module in COB technology. Assembled on MCPCB and mounted on to heat conductive material.
Driver	High quality Dimmable Driver (1-10V) in constant current. Conform to applicable safety standards and electromagnetic compatibility.
Internal Wire	Tinned copper conductor with silicone insulated internal wire. IMQ approved. Working temperature -40°C to +180°C. Class1 luminaire provided with the earth connection.
Pre-Wire Cable	Pre-wired with 5-core cable for power (3x1 sqmm.) and dimming signal (2x0.35 sqmm.).
Caution	Installation work has to be carried on according to the enclosed installation manual. The water drainage system must be tested to ensure that it is working sufficiency and efficiency.

Light Distribution

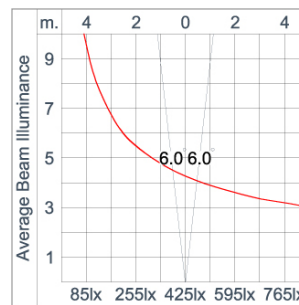
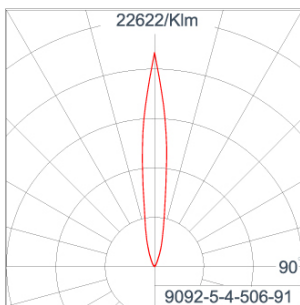

*Due to the constancy of product development,
we reserve the right to alter all specification
without prior notice.

Unilamp Co., Ltd.
461 Ramintra Road, Kannayao, Bangkok 10230 Thailand
Tel : +66[0]2 943 2420-1, +66[0]2 946 4170-1
Fax : +66[0]2 943 2419
online@unilamp.co.th
www.unilamp.co.th

GRAVITON

GRAVITON SQUARE IN-GROUND UPLIGHTER INGROUND



LAST UPDATE: 15-05-2024

Accessories



Ordering Code:
AUN-CON-0008-00
IP68 Connector, cable
diameter 8-10mm,
gel-filled for through wiring
, 1-10V or DALI

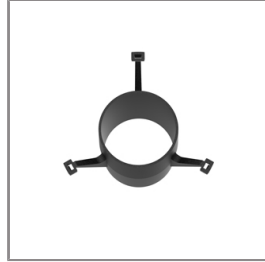

Ordering Code:
AUN-GHS-0025-00
Glare shield ring, COB

*Due to the constancy of product development,
we reserve the right to alter all specification
without prior notice.

Unilamp Co., Ltd.
461 Ramintra Road, Kannayao, Bangkok 10230 Thailand
Tel : +66[0]2 943 2420-1, +66[0]2 946 4170-1
Fax : +66[0]2 943 2419
online@unilamp.co.th
www.unilamp.co.th