

ATOM

ATOM – CC

INGROUND

 **Unilamp**

LAST UPDATE: 21-03-2025



ATOM is a ground recess indicator light suitable for above water and under water light application. ATOM has been designed and manufactured at highest attribute. Utilizing CNC lathed stainless steel body presented exceptional aesthetic as well as sleek tough feeling. LED chips and lenses are from world renowned manufacturers. GFR polymer recess kit allows it to be installed in most extreme environment. Ensuring integrity of manufacture ATOM is supplied with a factory fitted pre-wired cable for ease of installation. The Anti-Humidity kit eliminate condensation inside the housing and prolong the life time of the luminaire. An optional IP68 connectors is recommended as an accessory for trouble free installation.

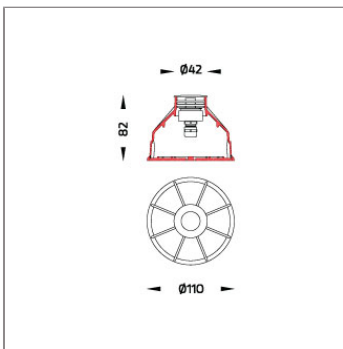

Technical Data



Ordering Code :	9090-5-2-989-91
Lamp :	LED
Beam :	19°
CCT :	3000 K
CRI :	CRI >80
SDCM :	SDCM = 3
Lamp Lumen :	260 lm
Luminaire Lumen :	190 lm
Lamp Wattage :	2.1 W[700mA]
Luminaire Wattage :	2.1 W
Efficacy :	90 lm/W
Ambient Temperature :	50°C
Lumen Maintenance	L80B10 >108,000 h
Controller :	Remote
Input Voltage :	700mA, 2.98Vdc, Uin max 50Vdc
Net Weight :	0.40 kg.

Ordering code guide

XXXX-X-X-XXX-XX
A B C D E

- A Product Code
- B Reflector
- C Electrical Component
- D Lamp
- E Color



Icon definition

*Due to the constancy of product development, we reserve the right to alter all specification without prior notice.

Unilamp Co., Ltd.
461 Ramintra Road, Kannayao, Bangkok 10230 Thailand
Tel : +66(O)2 943 2420-1, +66(O)2 946 4170-1
Fax : +66(O)2 943 2419
online@unilamp.co.th
www.unilamp.co.th

Specification

IEC Standard	IEC 60598-1 General Requirement IEC 60598-2-13 Ground Recessed Luminaires
Protection	IP68 Class III
IK Rating	Protection against mechanical impact IK10 on body and IK07 on optical part.
Luminaires Body Housing	Supreme corrosion proof Under Water grade Stainless Steel. Recessed housing made of GFR polymer. Luminaire withstands a maximum static load of 500 kg.
Diffuser	Impact resistant safety tempered glass cover. Able to withstand the temperature up to 250°C.
Lens	Molded PC lens from renowned manufacturers in various light distribution patterns.
Gasket	Post-cured treated silicone gasket. Temperature and weather resistant. Working temperature -40°C to +200°C.
External Screws	External screws are in stainless steel with protection grease.
Cable Entry	Cable entry protected by M12 cable gland. To be used with H05RN-F/ H07RN-F cable with 4-7mm. diameter.
Led	High efficiency LED module utilized chips from world renowned manufacturer. Assembled on MCPCB and mounted on to heat conductive material.
Driver	Driver is not included and has to be ordered separately.
Internal Wire	Tinned copper conductor with silicone insulated internal wire. IMQ approved. Working temperature -40°C to +180°C.
Pre-Wire Cable	Pre-wired with 2x1.0 sqmm. H05RN-F neoprene cable. IMQ approved.
Caution	Installation work has to be carried on according to the enclosed installation manual. The water drainage system must be tested to ensure that it is working sufficiency and efficiency.

Light Distribution

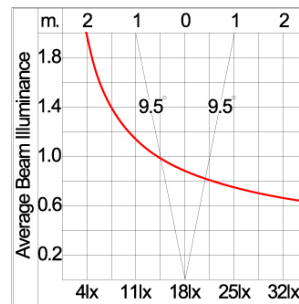
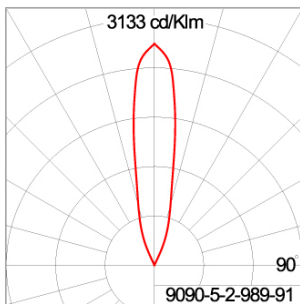

Accessories

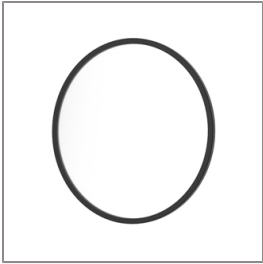

Ordering Code:
AUN-SOF-0055-00
Softening filter, LED,
pre-assembly from factory



Ordering Code:
AUN-GOP-0101-01
LED constant current
driver, 700mA, 4W, with
IP67 GFR polymer
enclosure, On-Off



Ordering Code:
AUN-COV-0002-00
LED constant current
converter input 12-24VDC,
700mA, 14W, with IP67
GFR polymer enclosure,
On-Off



Ordering Code:
AUN-DRG-0012-00
LED constant current
driver, 700mA, 20W, with
IP67 GFR polymer
enclosure, DALI, with IP68
series distribution box for
2-3 luminaires



Ordering Code:
AUN-CON-0024-00
IP68 Connector, cable
diameter 4.8-6mm,
gel-filled



Ordering Code:
AUN-CON-0007-00
IP68 distribution box,
series wiring, for 1-3
luminaires

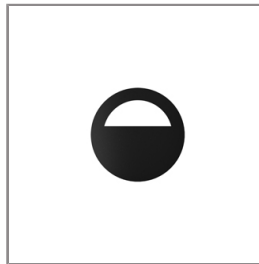

Ordering Code:
AUN-MIS-0020-01
Eyelid, pre-assembly from
factory