

POLKA

POLKA – CV
INGROUND



LAST UPDATE: 05-08-2024



The POLKA family of projectors and ground-recessed luminaires is characterized by a small size. The forged aluminum housing exhibits exceptional strength against mechanical impact and corrosion resistance. Several light distributions and color temperatures are available as a standard option. POLKA is equipped with the UniBlock anti-humidity kit for improved reliability and resilience against ingress of moisture. POLKA is also available in stainless steel, refer to the ATOM family for details.

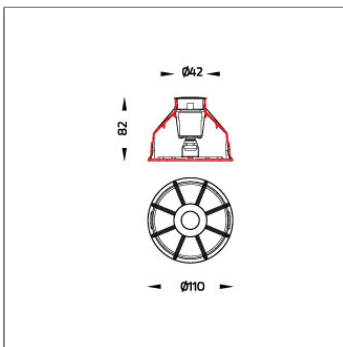

Technical Data



Ordering Code :	9082-0-2-525-13
Lamp :	LED
CCT :	2700 K
CRI :	CRI >80
SDCM :	SDCM = 3
Lamp Lumen :	260 lm
Luminaire Lumen :	59 lm
Lamp Wattage :	2.1 W[12Vdc/24Vdc]
Luminaire Wattage :	2.1 W
Efficacy :	28 lm/W
Ambient Temperature :	50°C
Lumen Maintenance	L80B10 >108,000 h
Controller :	Remote
Input Voltage :	24Vdc
Net Weight :	- kg.

Ordering code guide

XXXX-X-X-XXX-XX
A B C D E

- A Product Code
- B Reflector
- C Electrical Component
- D Lamp
- E Color



Icon definition

*Due to the constancy of product development, we reserve the right to alter all specification without prior notice.

Unilamp Co., Ltd.
461 Ramintra Road, Kannayao, Bangkok 10230 Thailand
Tel : +66[0]2 943 2420-1, +66[0]2 946 4170-1
Fax : +66[0]2 943 2419
online@unilamp.co.th
www.unilamp.co.th

POLKA

POLKA – CV

INGROUND

 **Unilamp**

LAST UPDATE: 05-08-2024

Specification

IEC Standard	IEC 60598-1 General Requirement IEC 60598-2-13 Ground Recessed Luminaires
Protection	IP67 Class III
Luminaires Body Housing	Extruded Aluminium 56063 alloy body with low copper content. Recessed housing made of GFR polymer.
Diffuser	Tempered safety glass cover
Gasket	Durable silicone gasket
External Screws	External screws made of stainless steel
Led	High efficiency LED module
Driver	Driver is not included and has to be ordered separately.
Pre-Wire Cable	Pre-wired with 2x0.5mm. cable
Caution	Installation work has to be carried on according to the enclosed installation manual. The water drainage system must be tested to ensure that it is working sufficiency and efficiency.

Light Distribution

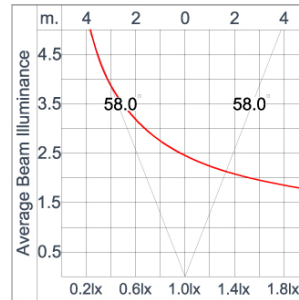
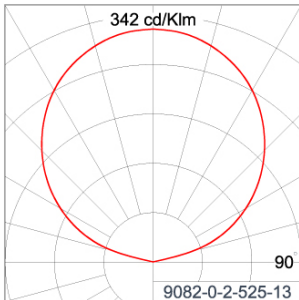

*Due to the constancy of product development,
we reserve the right to alter all specification
without prior notice.

Unilamp Co., Ltd.
461 Ramintra Road, Kannayao, Bangkok 10230 Thailand
Tel : +66[0]2 943 2420-1, +66[0]2 946 4170-1
Fax : +66[0]2 943 2419
online@unilamp.co.th
www.unilamp.co.th

POLKA

POLKA – CV

INGROUND



LAST UPDATE: 05-08-2024

Accessories



Ordering Code:
AUN-SOF-0055-00
Softening filter, LED,
pre-assembly from factory



Ordering Code:
AUN-CON-0024-00
IP68 Connector, cable
diameter 4.8-6mm,
gel-filled



Ordering Code:
AUN-DRG-0027-00
LED constant voltage
driver, 24VDC, 72W

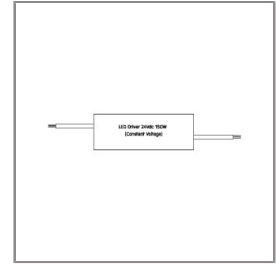

Ordering Code:
AUN-DRG-0011-00
LED constant voltage
driver, 24VDC, 150W



Ordering Code:
AUN-DRG-0024-00
LED constant voltage
driver, 24VDC, 200W

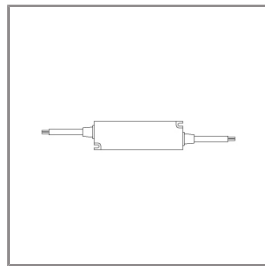

Ordering Code:
AUN-DRG-0118-00
LED constant voltage
driver, 24VDC, 30W

*Due to the constancy of product development,
we reserve the right to alter all specification
without prior notice.

Unilamp Co., Ltd.
461 Ramintra Road, Kannayao, Bangkok 10230 Thailand
Tel : +66(0)2 943 2420-1, +66(0)2 946 4170-1
Fax : +66(0)2 943 2419
online@unilamp.co.th
www.unilamp.co.th