

QUARK

MINI QUARK ROUND – CC [DMX]

INGROUND



LAST UPDATE: 18-06-2024



QUARK and Mini QUARK a family of walkover and drive over in-ground uplighter with shallow housing for minimum recess depth. Designed for high power LED with the choices of three different color temperatures from 2700K, 3000K or 4000K in high color consistency and remarkable color rendering index. QUARK is also available in HID light source with conventional control gear. The light distribution is available in various pattern e.g. wall wash, bi-symmetric, narrow, medium, wide and elliptical beam. QUARK is ideal for the illumination of plants, flagpoles, columns, walls, building facades and also architectural works and landmarks. The luminaire is fitted with a pre-wired supply cable for in-ground application and internally potted to prevent humidity and condensation. It is available in two sizes with integrated on-off or dimmable driver. Gel-filled IP 68 connecting devices are available as an accessory.

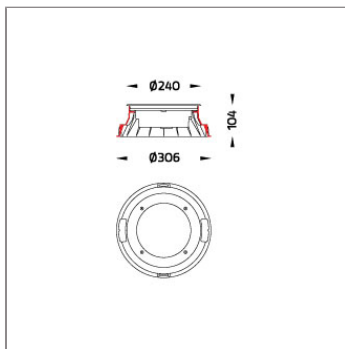

Technical Data



Ordering Code :	9035-7-D-687-91
Lamp :	LED
Beam :	46°
CCT :	RGBW
CRI :	CRI >40
SDCM :	SDCM = 5
Lamp Lumen :	2260 lm
Luminaire Lumen :	1470 lm
Lamp Wattage :	22 W[500mA]
Luminaire Wattage :	22 W
Efficacy :	66 lm/W
Ambient Temperature :	40°C
Lumen Maintenance	L70B10 >66,000 h
Controller :	Remote
Input Voltage :	500mA, 4CHx9Vdc-12Vdc, Uin max 150Vdc
Net Weight :	3.00 kg.

Ordering code guide

XXXX-X-X-XXX-XX

B
D

A
C
E

- A Product Code
- B Reflector
- C Electrical Component
- D Lamp
- E Color



Icon definition

*Due to the constancy of product development, we reserve the right to alter all specification without prior notice.

Unilamp Co., Ltd.
 461 Ramintra Road, Kannayao, Bangkok 10230 Thailand
 Tel : +66[0]2 943 2420-1, +66[0]2 946 4170-1
 Fax : +66[0]2 943 2419
 online@unilamp.co.th
 www.unilamp.co.th

Specification

IEC Standard	IEC 60598-1 General Requirement IEC 60598-2-13 Ground Recessed Luminaires
Protection	IP67 Class III
IK Rating	Protection against mechanical impact IK10 on body and optical part.
Luminaires Body Housing	High-pressure die cast aluminum alloy body and components. Front cover in 316 stainless steel brush finished. Recessed housing made of GFR polymer. Luminaire withstands a maximum static load of 1000 kg.
Coating Process	Nano Ceramic surface conversion, resistant to corrosive environment. Luminaire primarily coated with epoxy resin and top coated with UV stabilized polyester powder and cured in digital temperature controlled chamber at 200°C.
Diffuser	Impact resistant safety tempered glass cover. Able to withstand the temperature up to 250°C. Glass flushes to the front cover, no accumulation of dust and water.
Lens	Molded PC lens from renowned manufacturers in various light distribution patterns.
Gasket	Post-cured treated silicone gasket. Temperature and weather resistant. Working temperature -40°C to +200°C.
External Screws	External screws are in stainless steel with protection grease.
Cable Entry	Cable entry protected by M20 cable gland. To be used with H05RN-F/ H07RN-F cable with 7-13mm. diameter.
Led	High efficiency LED module utilized chips from world renowned manufacturer. Assembled on MCPCB and mounted on to heat conductive material.
Driver	Driver is not included and has to be ordered separately.
Internal Wire	Tinned copper conductor with silicone insulated internal wire. IMQ approved. Working temperature -40°C to +180°C.
Pre-Wire Cable	Pre-wired with 5x1.0 sqmm. PP + TPE cable. VDE approved.
Caution	Installation work has to be carried on according to the enclosed installation manual. The water drainage system must be tested to ensure that it is working sufficiency and efficiency.

Light Distribution

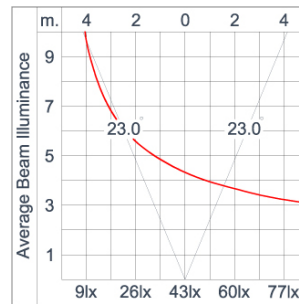
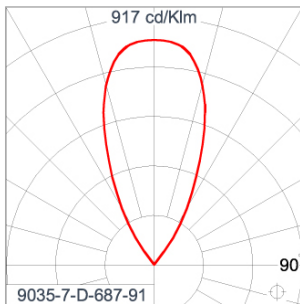

QUARK

MINI QUARK ROUND – CC [DMX]

INGROUND



LAST UPDATE: 18-06-2024

Accessories

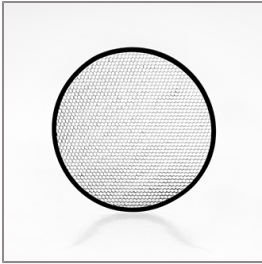

Ordering Code:
AUN-GSH-0005-00
Honeycomb louver, LED,
symmetric beam,
pre-assembly from factory



Ordering Code:
AUN-SOF-0016-00
Softening filter, LED,
pre-assembly from factory



Ordering Code:
AUN-CON-0009-00
IP68 connection device,
cable diameter 5-9.5mm,
On-Off



Ordering Code:
AUN-CON-0010-00
IP68 connection device 3
pole, cable diameter
5-9.5mm, with distribution
block

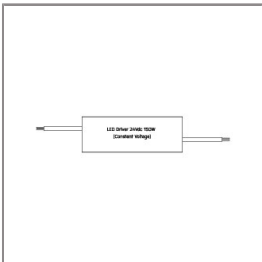

Ordering Code:
AUN-DRG-0011-00
LED constant voltage
driver, 24VDC, 150W

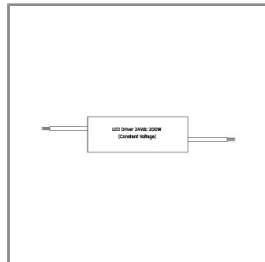

Ordering Code:
AUN-DRG-0024-00
LED constant voltage
driver, 24VDC, 200W

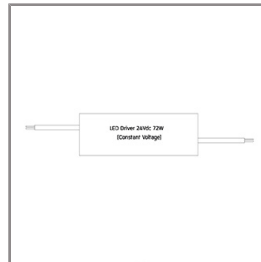

Ordering Code:
AUN-DRG-0027-00
LED constant voltage
driver, 24VDC, 72W



Ordering Code:
AUN-DRG-0113-01
LED constant current
decoder, 4x500mA,
4x16W, with IP67 GFR
polymer enclosure,
DMX512/RDM



Ordering Code:
AUN-DMX-0023-00
DMX controller, Nicolaudie
STICK-KE2



Ordering Code:
AUN-DMX-0024-00
DMX controller, Nicolaudie
SLESA-U9



Ordering Code:
AUN-DMX-0025-00
DMX controller, Nicolaudie
SLESA-U10



Ordering Code:
AUN-DMX-0026-00
XLR 3 pin male connector,
cable UNITRONIC Li2YCYv,
L= 1000, DMX

*Due to the constancy of product development,
we reserve the right to alter all specification
without prior notice.

Unilamp Co., Ltd.
461 Ramintra Road, Kannayao, Bangkok 10230 Thailand
Tel : +66[0]2 943 2420-1, +66[0]2 946 4170-1
Fax : +66[0]2 943 2419
online@unilamp.co.th
www.unilamp.co.th

QUARK

MINI QUARK ROUND – CC [DMX]

INGROUND



LAST UPDATE: 18-06-2024



Ordering Code:
AUN-DMX-0027-01
Splitter, IP67 aluminum enclosure, DMX



Ordering Code:
AUN-CON-0022-00
IP67 connection device, cable diameter 4.5-11mm, DMX



Ordering Code:
AUN-CON-0023-00
IP67 connection device, cable diameter 4.5-11mm, distribution block, DMX

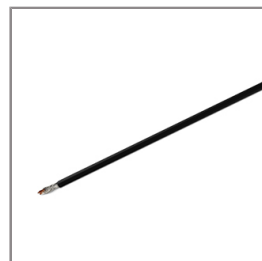

Ordering Code:
ATR-CAB-0006-00
Cable UNITRONIC Li2YCYv, L= 2000mm, DMX

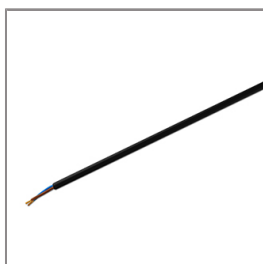

Ordering Code:
AUN-CAB-0040-00
Cable H07RN-F 2x1sqmm, L= 2000mm

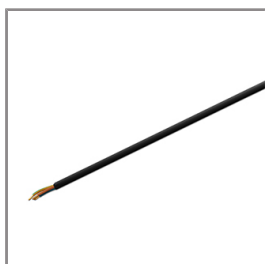

Ordering Code:
AUN-CAB-0039-00
Cable H07RN-F 3x1sqmm, L= 2000mm

*Due to the constancy of product development, we reserve the right to alter all specification without prior notice.

Unilamp Co., Ltd.
461 Ramintra Road, Kannayao, Bangkok 10230 Thailand
Tel : +66[0]2 943 2420-1, +66[0]2 946 4170-1
Fax : +66[0]2 943 2419
online@unilamp.co.th
www.unilamp.co.th