

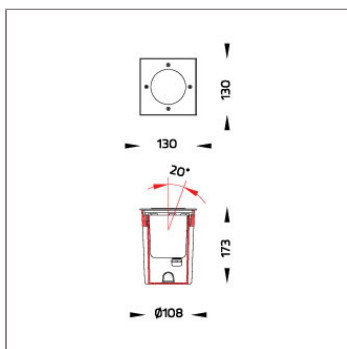

ZET walk-over in ground uplighter with fixed and adjustable optic utilized high-performance LED with additional glare control accessory to deliver the best and comfortable light distribution. ZET Adjustable is available in COB LED or High Power LED with various beam angle option. It is supplied with a post-cured silicone gasket with pre-wire cable for outdoor use. ZET is commonly used to highlight architectural tasks, wall structures, low ceilings, and columns. The glare-shield honey comb and softening lens are available as accessories. A gel-filled IP68 connection device for water tight connection is also available as standard option. Retrofit solution with GU5.3 or GU10 Led lamp base is presented in this family. The installation of this product and drainage system must be done according to the product's manual.



### Technical Data



Ordering Code :	9023-C-J-585-91
Lamp :	LED
Beam :	46°
CCT :	4000 K
CRI :	CRI >80
SDCM :	SDCM = 3
Lamp Lumen :	1030 lm
Luminaire Lumen :	790 lm
Lamp Wattage :	8.1 W[24Vdc]
Luminaire Wattage :	8.1 W
Efficacy :	97 lm/W
Ambient Temperature :	40°C
Lumen Maintenance	L70B10 >66,000 h
Controller :	Remote
Input Voltage :	24Vdc
Net Weight :	1.60 kg.

#### Ordering code guide

XXXX-X-X-XXX-XX

B
D

A
C
E

- A Product Code
- B Reflector
- C Electrical Component
- D Lamp
- E Color



Icon definition

### Specification

IEC Standard	IEC 60598-1 General Requirement IEC 60598-2-13 Ground Recessed Luminaires
Protection	IP67 Class III
IK Rating	Protection against mechanical impact IK10 on body and optical part.
Luminaires Body Housing	High-pressure die cast aluminum alloy body and components. Front cover in 316 stainless steel brush finished. Recessed housing made of GFR polymer. Luminaire withstands a maximum static load of 1000 kg.
Coating Process	Nano Ceramic surface conversion, resistant to corrosive environment. Luminaire primarily coated with epoxy resin and top coated with UV stabilized polyester powder and cured in digital temperature controlled chamber at 200°C.
Diffuser	Impact resistant safety tempered glass cover. Able to withstand the temperature up to 250°C. Glass flushes to the front cover, no accumulation of dust and water.
Lens	Molded PC lens from renowned manufacturers in various light distribution patterns.
Adjustable Optic	Adjustable optical unit.
Gasket	Weather resistant silicone gasket. Working temperature -40°C to +200°C.
External Screws	Marine grade 316 stainless steel screw.
Cable Entry	Cable entry protected by M16 cable gland. To be used with H05RN-F/ H07RN-F cable with 5-10mm. diameter.
Led	High efficiency LED module utilized chips from world renowned manufacturer. Assembled on MCPCB and mounted on to heat conductive material.
Driver	Driver is not included and has to be ordered separately.
Internal Wire	Tinned copper conductor with silicone insulated internal wire. IMQ approved. Working temperature -40°C to +180°C.
Pre-Wire Cable	Pre-wired with 2x1.0 sqmm. H07RN-F neoprene cable. IMQ approved.
Caution	Installation work has to be carried on according to the enclosed installation manual. The water drainage system must be tested to ensure that it is working sufficiency and efficiency.

### Light Distribution

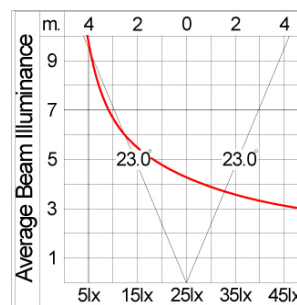
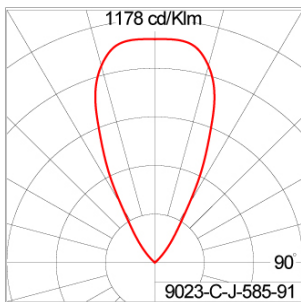

### Accessories

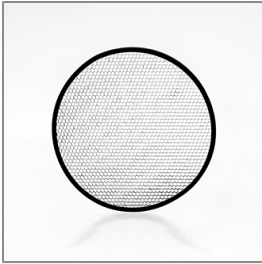

Ordering Code:  
AUN-GSH-0008-00  
Honeycomb louver, LED,  
pre-assembly from factory

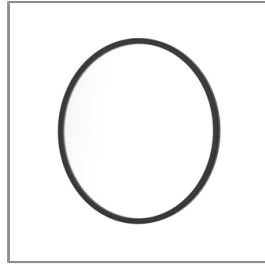

Ordering Code:  
AUN-SOF-0022-00  
Softening filter, LED,  
pre-assembly from factory



Ordering Code:  
AUN-DRG-0011-00  
LED constant voltage  
driver, 24VDC, 150W



Ordering Code:  
AUN-CON-0013-00  
IP68 connection device,  
cable diameter 7-11.5mm,  
On-Off



Ordering Code:  
AUN-CON-0004-00  
IP68 Connector, cable  
diameter 8-10mm,  
gel-filled



Ordering Code:  
AUN-CON-0003-00  
IP68 Connector, cable  
diameter 8-10mm,  
gel-filled for through wiring

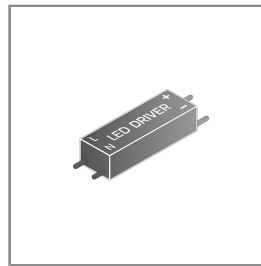

Ordering Code:  
AUN-DRG-0024-00  
LED constant voltage  
driver, 24VDC, 200W



Ordering Code:  
AUN-DRG-0027-00  
LED constant voltage  
driver, 24VDC, 72W

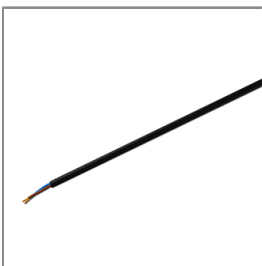

Ordering Code:  
AUN-CAB-0040-00  
Cable H07RN-F 2x1sqmm,  
L= 2000mm

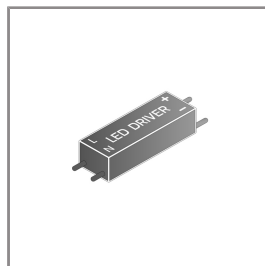

Ordering Code:  
AUN-DRG-0118-00  
LED constant voltage  
driver, 24VDC, 30W

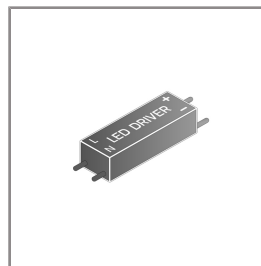

Ordering Code:  
AUN-DRG-0100-00  
LED constant voltage  
driver, 24VDC, 60W, DALI

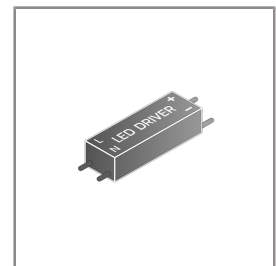

Ordering Code:  
AUN-DRG-0101-00  
LED constant voltage  
driver, 24VDC, 120W, DALI