

# SKUNA

## MEDIUM SKUNA

### BOLLARD



LAST UPDATE: 17-06-2024



A new compact bollard and wall luminaire family featuring robust aluminium housing with various type of light distribution. SKUNA utilized LED modules from renowned manufacturer with high precision optical lenses which offer narrow beam, medium beam, wide beam, forward throw and side throw light distribution. Featuring screw-less design housing made from copper free LM6 die-cast aluminium and S6063 extruded aluminium with Nano-Ceramic protection film for superior corrosion resistance. SKUNA is perfect for residential area as well as community-scale blocks.

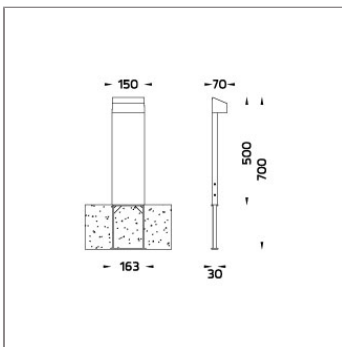

## Technical Data



Ordering Code :	7849-I-3-523-XX
Lamp :	LED
Beam :	Side throw
CCT :	2700 K
CRI :	CRI >80
SDCM :	SDCM = 3
Lamp Lumen :	960 lm
Luminaire Lumen :	510 lm
Lamp Wattage :	8.1 W
Luminaire Wattage :	10 W
Efficacy :	51 lm/W
Ambient Temperature :	50°C
Lumen Maintenance	L70B10 >66,000 h
Controller :	On-Off
Input Voltage :	220-240Vac 50/60Hz
Net Weight :	3.70 kg.

### Ordering code guide

XXXX-X-X-XXX-XX  
A B C D E

- A Product Code
- B Reflector
- C Electrical Component
- D Lamp
- E Color





















Icon definition

\*Due to the constancy of product development, we reserve the right to alter all specification without prior notice.

Unilamp Co., Ltd.  
461 Ramintra Road, Kannayao, Bangkok 10230 Thailand  
Tel : +66(0)2 943 2420-1, +66(0)2 946 4170-1  
Fax : +66(0)2 943 2419  
online@unilamp.co.th  
www.unilamp.co.th

### Specification

IEC Standard	IEC 60598-1 General Requirement IEC 60598-2-1 Fixed Luminaires												
Protection	IP66 Class I												
IK Rating	Protection against mechanical impact IK10 on body and IK08 on optical part.												
Luminaires Body Housing	High-pressure die cast aluminum alloy body and components. Extruded aluminum 56063 alloy body with low copper content. Hot-Dipped Galvanized Anchor Bolt Kit.												
Coating Process	Nano ceramic surface conversion, resistant to corrosive environment. Luminaire primarily coated with epoxy resin and top coated with UV stabilized polyester powder and cured in digital temperature controlled chamber at 200°C.												
Diffuser	Impact resistant safety tempered glass cover. Able to withstand the temperature up to 250°C.												
Lens	Molded PC lens from renowned manufacturers in various light distribution patterns.												
Gasket	Post-cured treated silicone gasket. Temperature and weather resistant. Working temperature -40°C to +200°C.												
External Screws	External screws are in stainless steel with protection grease.												
Cable Entry	Cable entry protected by M14 cable gland. To be used with HO5RN-F/ HO7RN-F cable with 5-8mm. diameter.												
Led	High efficiency LED module utilized chips from world renowned manufacturer. Assembled on MCPCB and mounted on to heat conductive material.												
Driver	High quality constant current LED driver. Conform to safety standard and electromagnetic compatibility standard.												
Internal Wire	Tinned copper conductor with silicone insulated internal wire. IMQ approved. Working temperature -40°C to +180°C.												
Terminal Block	Terminal block in GFR PA6.6 for cable with cross section up to 2.5 sqmm. VDE approved. Class1 luminaire provided with the earth connection.												
Pre-Wire Cable	Pre-wired with 3x1.0 sqmm. HO7RN-F neoprene cable. IMQ approved. Equipped with anti-humidity kit.												
Caution	Installation work has to be carried on according to the enclosed installation manual.												
Color	<table border="0"> <tr><td></td><td>Black O1</td></tr> <tr><td></td><td>Graphite O2</td></tr> <tr><td></td><td>Dark Grey O3</td></tr> <tr><td></td><td>Aluminum Silver O4</td></tr> <tr><td></td><td>White O6</td></tr> <tr><td></td><td>Wooden Brown O7</td></tr> </table>		Black O1		Graphite O2		Dark Grey O3		Aluminum Silver O4		White O6		Wooden Brown O7
	Black O1												
	Graphite O2												
	Dark Grey O3												
	Aluminum Silver O4												
	White O6												
	Wooden Brown O7												

### Light Distribution

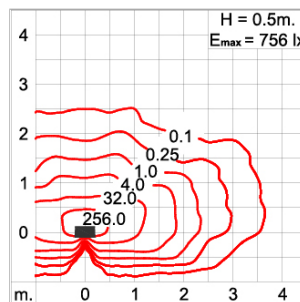
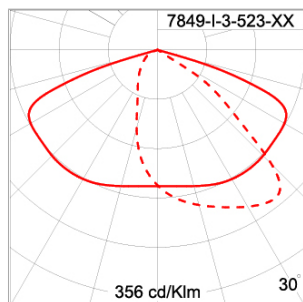

# SKUNA

## MEDIUM SKUNA

### BOLLARD



LAST UPDATE: 17-06-2024

#### Bug Report



#### Lum. Classification System (LCS)

LCS	Zone	%Lumens	%Lamp	%Lum
FL	[0-30]	79.3	8.3	15.3
FM	[30-60]	229.6	23.9	44.3
FH	[60-80]	90.8	9.5	17.5
FVH	[80-90]	2.0	0.2	0.4
BL	[0-30]	41.6	4.3	8.0
BM	[30-60]	53.5	5.6	10.3
BH	[60-80]	20.4	2.1	3.9
BVH	[80-90]	0.6	0.1	0.1
UL	[90-100]	< 0.05	0.0	0.0
UH	[100-180]	0.1	0.0	0.0
Total		517.9	54.0	100.0
BUG Rating		BO-U1-G0		

\*Due to the constancy of product development,  
we reserve the right to alter all specification  
without prior notice.

Unilamp Co., Ltd.  
461 Ramintra Road, Kannayao, Bangkok 10230 Thailand  
Tel : +66[0]2 943 2420-1, +66[0]2 946 4170-1  
Fax : +66[0]2 943 2419  
online@unilamp.co.th  
www.unilamp.co.th