

HYPERION

HYPERION 40

POLE MOUNTED LIGHT



LAST UPDATE: 22-05-2026



The HYPERION LED Post Top luminaire combines contemporary design with robust performance, making it ideal for lighting in parks, residential areas, pathways, and public spaces. Its seamless housing presents a refined architectural look, while precision optics ensure excellent light distribution and minimized glare for pedestrian comfort. Constructed from high-quality aluminum alloy and equipped with tempered glass and polycarbonate lenses, the fixture delivers durability and reliable outdoor operation. Rated IP66 and IK08, the HYPERION is built to withstand demanding environmental conditions. It is designed for 60 mm post-top mounting and is available in various wattages to accommodate a range of lighting applications.

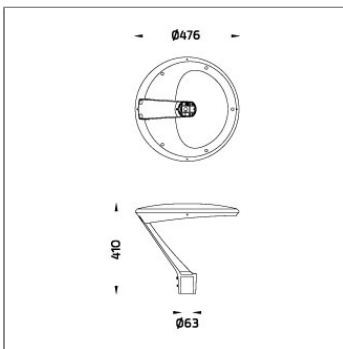

Technical Data



Ordering Code :	7739-T-3-005-XX
Lamp :	LED
Beam :	T4 - Asymmetric Forward Throw
CCT :	4000 K
CRI :	CRI >80
SDCM :	SDCM = 3
Luminaire Lumen :	5010 lm
Luminaire Wattage :	40 W
Efficacy :	125 lm/W
Ambient Temperature :	50°C
Lumen Maintenance	L80B10 >100,000 h (@25°C)
Controller :	On-Off
Input Voltage :	220-240Vac 50/60Hz
Net Weight :	7.10 kg.

Ordering code guide

XXXX-X-X-XXX-XX
A B C D E

- A Product Code
- B Reflector
- C Electrical Component
- D Lamp
- E Color



Icon definition

*Due to the constancy of product development, we reserve the right to alter all specification without prior notice.

Unilamp Co., Ltd.
461 Ramintra Road, Kannayao, Bangkok 10230 Thailand
Tel : +66(0)2 943 2420-1, +66(0)2 946 4170-1
Fax : +66(0)2 943 2419
online@unilamp.co.th
www.unilamp.co.th

HYPERION

HYPERION 40

POLE MOUNTED LIGHT



LAST UPDATE: 22-05-2026

Specification

IEC Standard	IEC 60598-1 General Requirement IEC 60598-2-1 Fixed Luminaires
Protection	IP66 Class I
IK Rating	Protection against mechanical impact IK08
Luminaires Body Housing	Durable high-pressure die-cast aluminum alloy for excellent mechanical performance.
Coating Process	UV-stabilized polyester powder-coated luminaire, digitally cured at 200°C.
Diffuser	Impact-resistant tempered glass designed for high-temperature environments.
Lens	Optically engineered molded PMMA lens designed for multiple light distribution needs.
Gasket	Advanced post-cured silicone gasket offering superior weather and thermal resistance [-40°C to +200°C].
External Screws	Durable stainless steel screws with anti-corrosion grease for extended lifespan.
Cable Entry	M20 cable gland for secure cable entry, compatible with H05RN-F/H07RN-F cables (7-13mm).
Led	Premium LED module with top-tier chips, mounted on MCPCB for heat efficiency.
Driver	Certified constant current LED driver meeting all EMC and safety requirements.
Internal Wire	Reliable silicone-insulated tinned copper internal wire, designed for -40°C to +180°C. Reliable silicone-insulated tinned copper internal wire, designed for -40°C to +180°C.
Pre-Wire Cable	Pre-wired 3x1 sqmm cable, 800mm in length, ready for installation.
Caution	Installation must be performed as per the provided installation instructions.
Color	 Black A1

Light Distribution

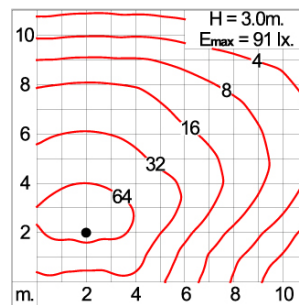
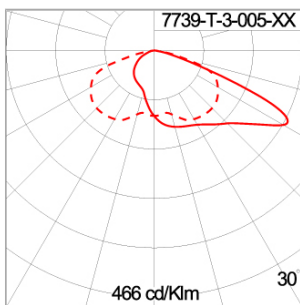

*Due to the constancy of product development, we reserve the right to alter all specification without prior notice.

Unilamp Co., Ltd.
461 Ramintra Road, Kannayao, Bangkok 10230 Thailand
Tel : +66(0)2 943 2420-1, +66(0)2 946 4170-1
Fax : +66(0)2 943 2419
online@unilamp.co.th
www.unilamp.co.th

HYPERION

HYPERION 40

POLE MOUNTED LIGHT



LAST UPDATE: 22-05-2026

Bug Report

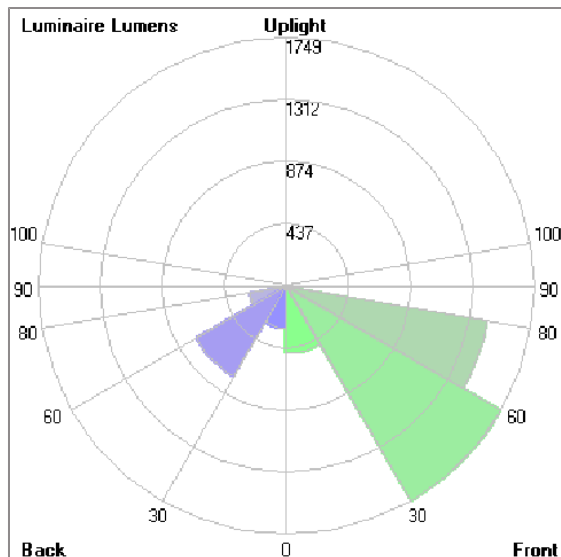

Lum. Classification System (LCS)

LCS	Zone	%Lumens	%Lamp	%Lum
FL	[0-30]	475.7	9.5	9.5
FM	[30-60]	1748.8	34.9	34.9
FH	[60-80]	1437.7	28.7	28.7
FVH	[80-90]	41.5	0.8	0.8
BL	[0-30]	300.1	6.0	6.0
BM	[30-60]	738.5	14.7	14.7
BH	[60-80]	262.8	5.2	5.2
BVH	[80-90]	5.3	0.1	0.1
UL	[90-100]	0.0	0.0	0.0
UH	[100-180]	0.0	0.0	0.0
Total		5010.4	99.9	100.0
BUG Rating		B1-U0-G1		

*Due to the constancy of product development,
we reserve the right to alter all specification
without prior notice.

Unilamp Co., Ltd.
461 Ramintra Road, Kannayao, Bangkok 10230 Thailand
Tel : +66(0)2 943 2420-1, +66(0)2 946 4170-1
Fax : +66(0)2 943 2419
online@unilamp.co.th
www.unilamp.co.th

HYPERION

HYPERION 40

POLE MOUNTED LIGHT



LAST UPDATE: 22-05-2026

Accessories



Ordering Code:
AUN-POL-0009-XX
Cylindrical aluminum pole,
diameter 105mm, H=
3000mm, spigot 60mm



Ordering Code:
AUN-POL-0010-XX
Cylindrical aluminum pole,
diameter 105mm, H=
3500mm, spigot 60mm



Ordering Code:
AUN-POL-0011-XX
Cylindrical aluminum pole,
diameter 105mm, H=
4000mm, spigot 60mm



Ordering Code:
AUN-ACB-0005-00
Anchor bolt kit, aluminum
pole

*Due to the constancy of product development,
we reserve the right to alter all specification
without prior notice.

Unilamp Co., Ltd.
461 Ramintra Road, Kannayao, Bangkok 10230 Thailand
Tel : +66[0]2 943 2420-1, +66[0]2 946 4170-1
Fax : +66[0]2 943 2419
online@unilamp.co.th
www.unilamp.co.th