

ATOM

ATOM – CV

UNDERWATER LIGHT



LAST UPDATE: 11-11-2025

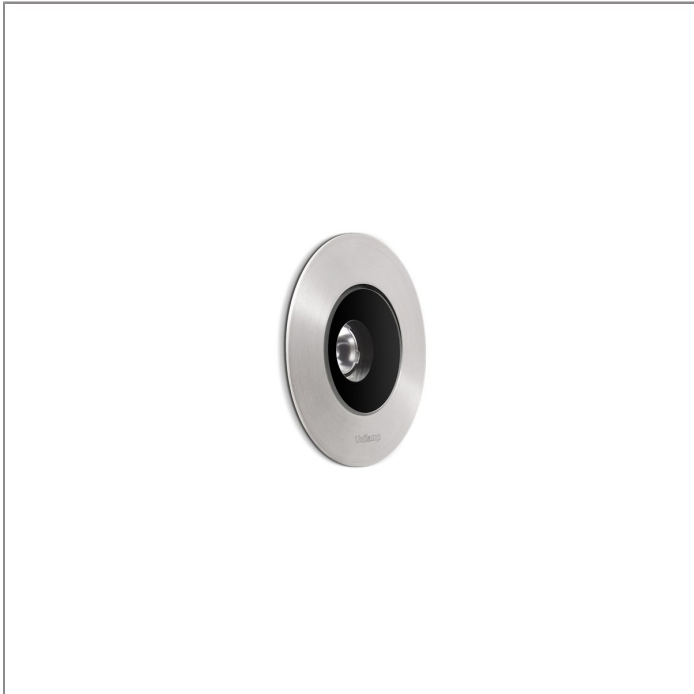

The ATOM family comprises versatile, CNC-lathed stainless steel ground-recessed luminaires designed for both above-water and underwater applications. Featuring high-performance LEDs and precision optics, they deliver reliable, accurate light distribution for architectural and landscape settings. Each unit includes an integrated anti-humidity kit to ensure longevity and comes pre-wired for easy installation. The series includes the standard ATOM, featuring a resilient GFR polymer recess kit, and the compact Mini ATOM, designed for discreet applications and supplied with a black anodized aluminum recess kit. Combining robust construction with high-quality components, the ATOM family offers a durable, stylish solution for diverse lighting needs.

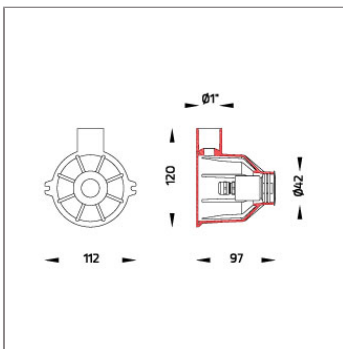

Technical Data



Ordering Code :	7480-A-2-470-91
Lamp :	LED
Beam :	15°
CCT :	3000 K
CRI :	CRI >90
SDCM :	SDCM = 3
Lamp Lumen :	190 lm
Luminaire Lumen :	140 lm
Lamp Wattage :	2 W[12Vdc/24Vdc]
Luminaire Wattage :	2.0 W
Efficacy :	70 lm/W
Ambient Temperature :	50°C
Controller :	Remote
Input Voltage :	12Vdc/24Vdc
Net Weight :	0.40 kg.

Ordering code guide

XXXX-X-X-XXX-XX

- A Product Code
- B Reflector
- C Electrical Component
- D Lamp
- E Color



Icon definition

*Due to the constancy of product development, we reserve the right to alter all specification without prior notice.

Unilamp Co., Ltd.
461 Ramintra Road, Kannayao, Bangkok 10230 Thailand
Tel : +66(O)2 943 2420-1, +66(O)2 946 4170-1
Fax : +66(O)2 943 2419
online@unilamp.co.th
www.unilamp.co.th

ATOM

ATOM – CV

UNDERWATER LIGHT



LAST UPDATE: 11-11-2025

Specification

IEC Standard	IEC 60598-1 General Requirement IEC 60598-2-18 Luminaires for Swimming Pools
Protection	IP68 Class III
IK Rating	Protection against mechanical impact IK10 on body and IK07 on optical part.
Luminaires Body Housing	Supreme corrosion proof Under Water grade Stainless Steel. Recessed housing made of GFR polymer.
Diffuser	Impact resistant safety tempered glass cover. Able to withstand the temperature up to 250°C.
Lens	Molded PC lens from renowned manufacturers in various light distribution patterns.
Gasket	Post-cured treated silicone gasket. Temperature and weather resistant. Working temperature -40°C to +200°C.
External Screws	External screws are in stainless steel with protection grease.
Cable Entry	Cable entry protected by M12 cable gland. To be used with H05RN-F/ H07RN-F cable with 4-7mm. diameter.
Led	High efficiency LED module utilized chips from world renowned manufacturer. Assembled on MCPCB and mounted on to heat conductive material.
Driver	Driver is not included and has to be ordered separately.
Internal Wire	Tinned copper conductor with silicone insulated internal wire. IMQ approved. Working temperature -40°C to +180°C.
Pre-Wire Cable	Pre-wired with 2x1.0 sqmm. H05RN-F neoprene cable. IMQ approved.
Caution	Installation work has to be carried on according to the enclosed installation manual. The water drainage system must be tested to ensure that it is working sufficiency and efficiency.

Light Distribution

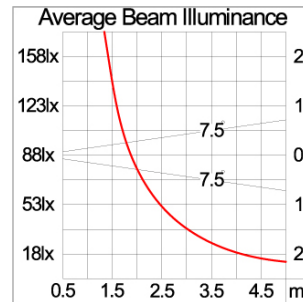
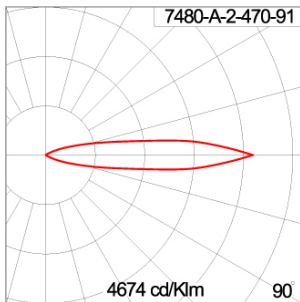

*Due to the constancy of product development,
we reserve the right to alter all specification
without prior notice.

Unilamp Co., Ltd.
461 Ramintra Road, Kannayao, Bangkok 10230 Thailand
Tel : +66(0)2 943 2420-1, +66(0)2 946 4170-1
Fax : +66(0)2 943 2419
online@unilamp.co.th
www.unilamp.co.th

Accessories



Ordering Code:
AUN-DRG-0114-01
LED constant voltage
driver, 12VDC, 12W, with
IP67 GFR polymer
enclosure



Ordering Code:
AUN-SOF-0055-00
Softening filter, LED,
pre-assembly from factory



Ordering Code:
AUN-DRG-0011-00
LED constant voltage
driver, 24VDC, 150W



Ordering Code:
AUN-CON-0024-00
IP68 Connector, cable
diameter 4.8-6mm,
gel-filled



Ordering Code:
AUN-DRG-0024-00
LED constant voltage
driver, 24VDC, 200W



Ordering Code:
AUN-DRG-0027-00
LED constant voltage
driver, 24VDC, 72W

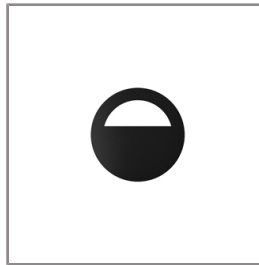

Ordering Code:
AUN-MIS-0020-01
Eyelid, pre-assembly from
factory



Ordering Code:
AUN-DRG-0118-00
LED constant voltage
driver, 24VDC, 30W

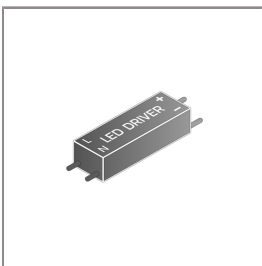

Ordering Code:
AUN-DRG-0100-00
LED constant voltage
driver, 24VDC, 60W, DALI

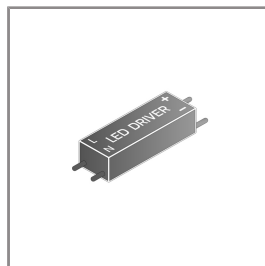

Ordering Code:
AUN-DRG-0101-00
LED constant voltage
driver, 24VDC, 120W, DALI



Ordering Code:
AUN-DRG-0126-00
LED constant current
driver, 250mA, 12W, with
IP67 GFR polymer
enclosure, On-Off, BLACK