

VAREE

MINI VAREE WALL RECESS

UNDERWATER LIGHT



LAST UPDATE: 21-04-2026



VAREE A family of LED underwater luminaires that is suitable to be installed on the ground, recess in a concrete wall or surface mounted. Operating with high lumen output LED from 2700K, 3000K, 4000K and RGBW with high CRI in 3 steps SDCM. VAREE is designed to illuminate swimming pools, decorative pools, fountains and any submersible application. A wide range of beam angles including Narrow, Medium, Wide and Elliptical beams as well as Asymmetric floor washer. VAREE is pre-wired with underwater cable and internally potted to prevent humidity and condensation. To avoid over-heating, VAREE is equipped with a thermal cut-off device thus the luminaire has to be submerged at all time. The marine grade 316 stainless steel material and advance polymer guarantees corrosion free appearance through out the life time. We highly recommend that the luminaire lay out should be considered during specifying and planning processes. Installation work must be carried out under national safety regulations.



Technical Data



Ordering Code :	7423-C-J-583-92
Lamp :	SMD-H LED
Beam :	47°
CCT :	2700 K
CRI :	CRI >80
SDCM :	SDCM = 3
Lamp Lumen :	1490 lm
Luminaire Lumen :	820 lm
Lamp Wattage :	14 W(24Vdc)
Luminaire Wattage :	14 W
Efficacy :	59 lm/W
Ambient Temperature :	50°C
Lumen Maintenance	L70B10 >66,000 h
Controller :	Remote
Input Voltage :	24Vdc
Net Weight :	- kg.

Ordering code guide

XXXX-X-X-XXX-XX
A B C D E

- A Product Code
- B Reflector
- C Electrical Component
- D Lamp
- E Color



Icon definition

*Due to the constancy of product development, we reserve the right to alter all specification without prior notice.

Unilamp Co., Ltd.
461 Ramintra Road, Kannayao, Bangkok 10230 Thailand
Tel : +66(O)2 943 2420-1, +66(O)2 946 4170-1
Fax : +66(O)2 943 2419
online@unilamp.co.th
www.unilamp.co.th

Specification

IEC Standard	IEC 60598-1 General Requirement IEC 60598-2-18 Luminaires for Swimming Pools
Protection	IP68 Class III
IK Rating	Protection against mechanical impact IK05 on body and IK07 on optical part.
Luminaires Body Housing	Superior corrosion-proof stainless steel, optimized for underwater durability. GFR polymer body ensuring lightweight durability and impact resistance.
Diffuser	Impact-resistant tempered glass designed for high-temperature environments.
Lens	Advanced molded PC lens offering diverse light distribution patterns.
Gasket	Advanced post-cured silicone gasket offering superior weather and thermal resistance [-40°C to +200°C].
External Screws	Marine-grade 316 stainless steel screws for superior corrosion resistance.
Cable Entry	M12 cable gland for secure cable entry, compatible with H05RN-F/H07RN-F cables (4-7mm).
Led	Premium LED module with top-tier chips, mounted on MCPCB for heat efficiency.
Driver	External driver required, available as a separate order.
Internal Wire	Durable PTFE-insulated internal wire with tinned copper conductor, operating from -40°C to +250°C.
Pre-Wire Cable	Certified pre-wired 2x1.0 sqmm cable, featuring H05RN-F neoprene insulation.
Caution	Installation must be performed as per the provided installation instructions. This luminaire must be used underwater to prevent overheating.

Light Distribution

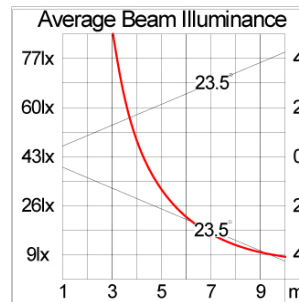
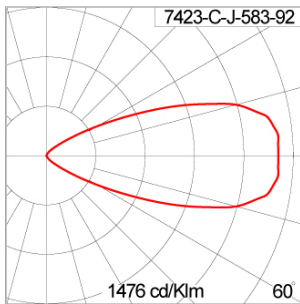

VAREE

MINI VAREE WALL RECESS

UNDERWATER LIGHT



LAST UPDATE: 21-04-2026

Bug Report

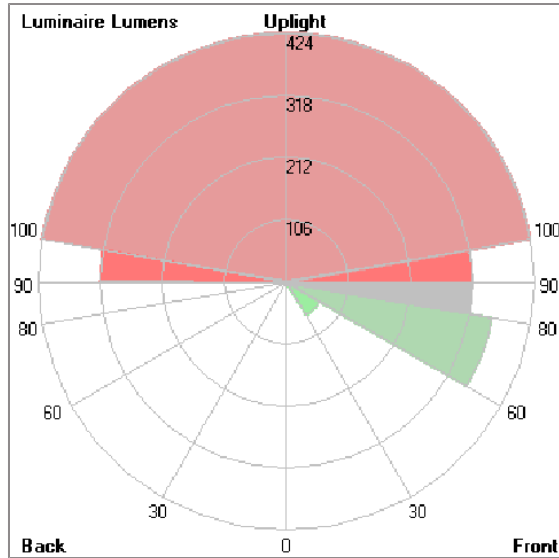

Lum. Classification System (LCS)

LCS	Zone	%Lumens	%Lamp	%Lum
FL	[0-30]	1.7	0.1	0.1
FM	[30-60]	66.2	4.4	4.5
FH	[60-80]	356.1	23.9	24.0
FVH	[80-90]	317.0	21.3	21.4
BL	[0-30]	0.0	0.0	0.0
BM	[30-60]	0.0	0.0	0.0
BH	[60-80]	0.0	0.0	0.0
BVH	[80-90]	0.0	0.0	0.0
UL	[90-100]	317.0	21.3	21.4
UH	[100-180]	423.9	28.5	28.6
Total		1481.9	99.5	100.0
BUG Rating		BO-U3-G3		

*Due to the constancy of product development, we reserve the right to alter all specification without prior notice.

Unilamp Co., Ltd.
461 Ramintra Road, Kannayao, Bangkok 10230 Thailand
Tel : +66(0)2 943 2420-1, +66(0)2 946 4170-1
Fax : +66(0)2 943 2419
online@unilamp.co.th
www.unilamp.co.th

Accessories



Ordering Code:
AUN-GSH-0008-00
Honeycomb louver, LED,
pre-assembly from factory



Ordering Code:
AUN-SOF-0022-00
Softening filter, LED,
pre-assembly from factory



Ordering Code:
AUN-DRG-0011-00
LED constant voltage
driver, 24VDC, 150W



Ordering Code:
AUN-CON-0024-00
IP68 Connector, cable
diameter 4.8-6mm,
gel-filled



Ordering Code:
AUN-DRG-0027-00
LED constant voltage
driver, 24VDC, 72W