

VOLGA

VOLGA/1 – CV WALL RECESS UNDER WATER

UNDERWATER LIGHT



LAST UPDATE: 23-04-2026



VOLGA is a marine-grade stainless steel luminaire for underwater and off-water use. Suitable for ground and wall-recessed mounting, it features high-power LEDs and adjustable beams. Ideal for pools, fountains, and columns, it comes pre-wired and sealed. Made from 316 stainless steel, VOLGA ensures corrosion-free durability.

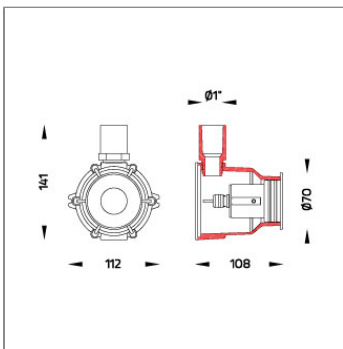

Technical Data



Ordering Code :	7418-H-2-374-91
Lamp :	LED
Beam :	40°/20°
CCT :	4000 K
CRI :	CRI >80
SDCM :	SDCM = 3
Lamp Lumen :	720 lm
Luminaire Lumen :	390 lm
Lamp Wattage :	5.8 W(24Vdc)
Luminaire Wattage :	5.8 W
Efficacy :	67 lm/W
Ambient Temperature :	50°C
Lumen Maintenance	L80B10 >145,000 h
Controller :	Remote
Input Voltage :	24Vdc
Net Weight :	- kg.

Ordering code guide

XXXX-X-X-XXX-XX
A B C D E

- A Product Code
- B Reflector
- C Electrical Component
- D Lamp
- E Color



Icon definition

*Due to the constancy of product development, we reserve the right to alter all specification without prior notice.

Unilamp Co., Ltd.
461 Ramintra Road, Kannayao, Bangkok 10230 Thailand
Tel : +66(O)2 943 2420-1, +66(O)2 946 4170-1
Fax : +66(O)2 943 2419
online@unilamp.co.th
www.unilamp.co.th

VOLGA

VOLGA/1 – CV WALL RECESS UNDER WATER

UNDERWATER LIGHT



LAST UPDATE: 23-04-2026

Specification

IEC Standard	IEC 60598-1 General Requirement IEC 60598-2-18 Luminaires for Swimming Pools
Protection	IP68 Class III
Luminaires Body Housing	Supreme corrosion proof Under Water grade Stainless Steel. Recessed housing made of GFR polymer.
Diffuser	Impact resistant safety tempered glass cover. Able to withstand the temperature up to 250°C.
Lens	Molded PC lens from renowned manufacturers in various light distribution patterns.
Gasket	Post-cured treated silicone gasket. Temperature and weather resistant. Working temperature -40°C to +200°C.
External Screws	External screws are in stainless steel with protection grease.
Cable Entry	Cable entry protected by M12 cable gland. To be used with H05RN-F/ H07RN-F cable with 4-7mm. diameter.
Led	High efficiency LED module utilized chips from world renowned manufacturer. Assembled on MCPCB and mounted on to heat conductive material.
Driver	Driver is not included and has to be ordered separately.
Internal Wire	Tinned copper conductor with silicone insulated internal wire. IMQ approved. Working temperature -40°C to +180°C.
Pre-Wire Cable	Pre-wired with 2x1.0 sqmm. H05RN-F neoprene cable. IMQ approved.
Caution	Installation work has to be carried on according to the enclosed installation manual. The water drainage system must be tested to ensure that it is working sufficiency and efficiency.

Light Distribution

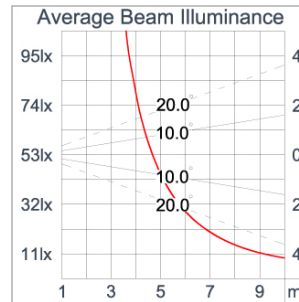
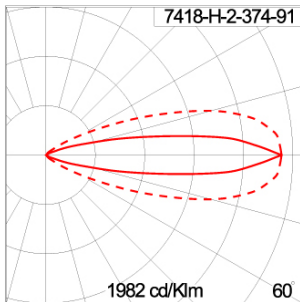

*Due to the constancy of product development, we reserve the right to alter all specification without prior notice.

Unilamp Co., Ltd.
461 Ramintra Road, Kannayao, Bangkok 10230 Thailand
Tel : +66[0]2 943 2420-1, +66[0]2 946 4170-1
Fax : +66[0]2 943 2419
online@unilamp.co.th
www.unilamp.co.th

VOLGA

VOLGA/1 – CV WALL RECESS UNDER WATER

UNDERWATER LIGHT



LAST UPDATE: 23-04-2026

Accessories

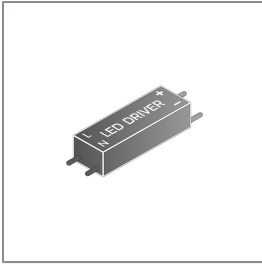

Ordering Code:
AUN-DRG-0011-00
LED constant voltage
driver, 24VDC, 150W

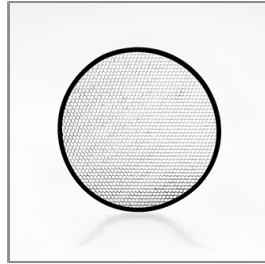

Ordering Code:
AUN-GSH-0017-00
Honeycomb louver, LED,
pre-assembly from factory

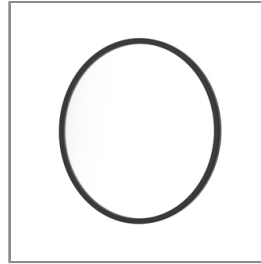

Ordering Code:
AUN-SOF-0029-00
Softening filter, LED,
pre-assembly from factory



Ordering Code:
AUN-CON-0024-00
IP68 Connector, cable
diameter 4.8-6mm,
gel-filled

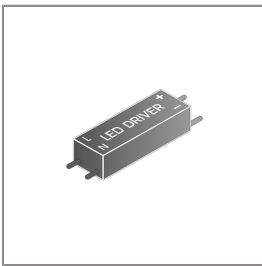

Ordering Code:
AUN-DRG-0024-00
LED constant voltage
driver, 24VDC, 200W

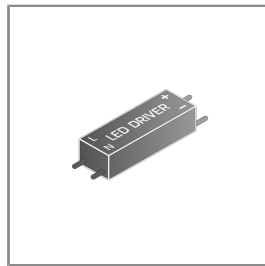

Ordering Code:
AUN-DRG-0027-00
LED constant voltage
driver, 24VDC, 72W

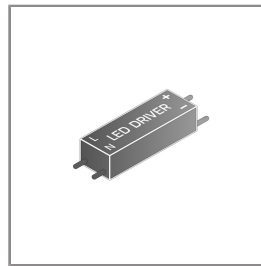

Ordering Code:
AUN-DRG-0118-00
LED constant voltage
driver, 24VDC, 30W



Ordering Code:
AUN-DRG-0126-00
LED constant current
driver, 250mA, 12W, with
IP67 GFR polymer
enclosure, On-Off, BLACK

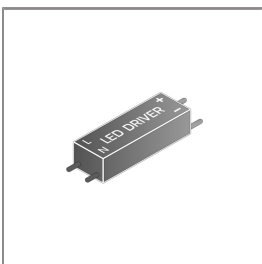

Ordering Code:
AUN-DRG-0100-00
LED constant voltage
driver, 24VDC, 60W, DALI

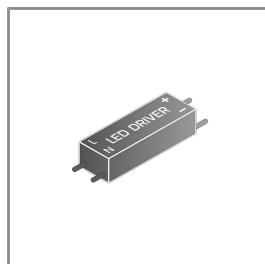

Ordering Code:
AUN-DRG-0101-00
LED constant voltage
driver, 24VDC, 120W, DALI

*Due to the constancy of product development,
we reserve the right to alter all specification
without prior notice.

Unilamp Co., Ltd.
461 Ramintra Road, Kannayao, Bangkok 10230 Thailand
Tel : +66[0]2 943 2420-1, +66[0]2 946 4170-1
Fax : +66[0]2 943 2419
online@unilamp.co.th
www.unilamp.co.th