

# VOLGA

## VOLGA/1 – CV WALL RECESS UNDER WATER

### UNDERWATER LIGHT



LAST UPDATE: 19-03-2025



VOLGA is a family of robust marine grade stainless steel luminaires suitable for underwater and ground and well recessed mounting. It utilizes high power LED in available with different color temperatures. The high quality optical lenses offering beams from ultra-narrow to wide and asymmetric light distributions. VOLGA is a perfect choice to illuminate swimming pools, decorative pools and fountains and narrow columns. The luminaire is supplied with pre-wired cable, anti-humidity kit and is fully sealed from the factory. The underwater version must be operated submersed in water at all time in order to prevent over-heating of the luminaire. VOLGA inground and wall recessed is suitable for in air operation. The marine grade 316 stainless steel body guarantees corrosion free appearance throughout the lifetime. We highly recommend that the luminaire lay out should be considered during specifying and planning processes. Installation work must be carried out under national safety regulations.

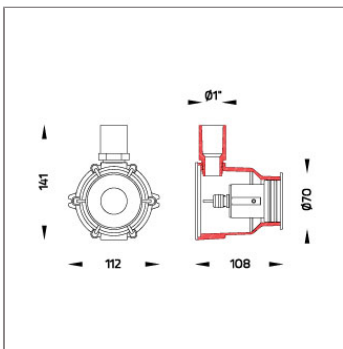

### Technical Data



Ordering Code :	7418-0-2-374-91
Lamp :	LED
CCT :	4000 K
CRI :	CRI >80
SDCM :	SDCM = 3
Lamp Lumen :	720 lm
Luminaire Lumen :	50 lm
Lamp Wattage :	5.8 W[24Vdc]
Luminaire Wattage :	5.8 W
Efficacy :	8 lm/W
Ambient Temperature :	50°C
Lumen Maintenance	L80B10 >145,000 h
Controller :	Remote
Input Voltage :	24Vdc
Net Weight :	- kg.

#### Ordering code guide

XXXX-X-X-XXX-XX  
A B C D E

- A Product Code
- B Reflector
- C Electrical Component
- D Lamp
- E Color



Icon definition

\*Due to the constancy of product development, we reserve the right to alter all specification without prior notice.

Unilamp Co., Ltd.  
461 Ramintra Road, Kannayao, Bangkok 10230 Thailand  
Tel : +66[0]2 943 2420-1, +66[0]2 946 4170-1  
Fax : +66[0]2 943 2419  
online@unilamp.co.th  
www.unilamp.co.th

# VOLGA

## VOLGA/1 – CV WALL RECESS UNDER WATER

### UNDERWATER LIGHT



LAST UPDATE: 19-03-2025

#### Specification

IEC Standard	IEC 60598-1 General Requirement IEC 60598-2-18 Luminaires for Swimming Pools
Protection	IP68 Class III
Luminaires Body Housing	Supreme corrosion proof Under Water grade Stainless Steel. Recessed housing made of GFR polymer.
Diffuser	Impact resistant safety tempered glass cover. Able to withstand the temperature up to 250°C.
Gasket	Post-cured treated silicone gasket. Temperature and weather resistant. Working temperature -40°C to +200°C.
External Screws	External screws are in stainless steel with protection grease.
Cable Entry	Cable entry protected by M12 cable gland. To be used with H05RN-F/ H07RN-F cable with 4-7mm. diameter.
Led	High efficiency LED module utilized chips from world renowned manufacturer. Assembled on MCPCB and mounted on to heat conductive material.
Driver	Driver is not included and has to be ordered separately.
Internal Wire	Tinned copper conductor with silicone insulated internal wire. IMQ approved. Working temperature -40°C to +180°C.
Pre-Wire Cable	Pre-wired with 2x1.0 sqmm. H05RN-F neoprene cable. IMQ approved.
Caution	Installation work has to be carried on according to the enclosed installation manual. The water drainage system must be tested to ensure that it is working sufficiency and efficiency.

#### Light Distribution

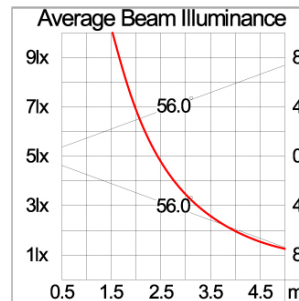
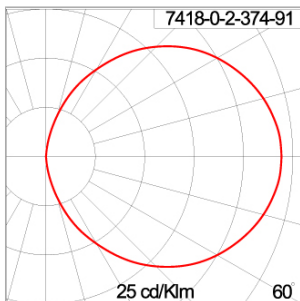

\*Due to the constancy of product development, we reserve the right to alter all specification without prior notice.

Unilamp Co., Ltd.  
461 Ramintra Road, Kannayao, Bangkok 10230 Thailand  
Tel : +66(0)2 943 2420-1, +66(0)2 946 4170-1  
Fax : +66(0)2 943 2419  
online@unilamp.co.th  
www.unilamp.co.th

# VOLGA

## VOLGA/1 – CV WALL RECESS UNDER WATER

### UNDERWATER LIGHT



LAST UPDATE: 19-03-2025

#### Accessories



Ordering Code:  
AUN-DRG-0011-00  
LED constant voltage  
driver, 24VDC, 150W



Ordering Code:  
AUN-CON-0024-00  
IP68 Connector, cable  
diameter 4.8-6mm,  
gel-filled

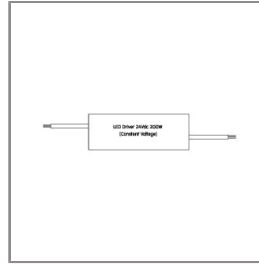

Ordering Code:  
AUN-DRG-0024-00  
LED constant voltage  
driver, 24VDC, 200W

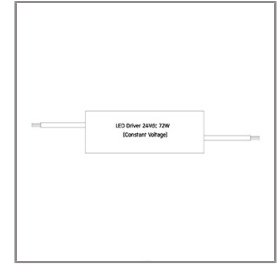

Ordering Code:  
AUN-DRG-0027-00  
LED constant voltage  
driver, 24VDC, 72W

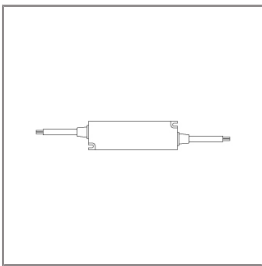

Ordering Code:  
AUN-DRG-0118-00  
LED constant voltage  
driver, 24VDC, 30W

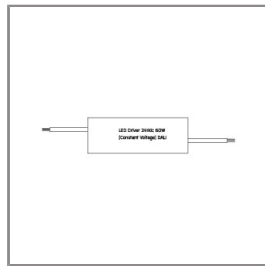

Ordering Code:  
AUN-DRG-0100-00  
LED constant voltage  
driver, 24VDC, 60W, DALI

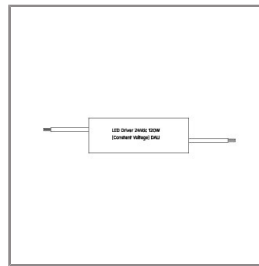

Ordering Code:  
AUN-DRG-0101-00  
LED constant voltage  
driver, 24VDC, 120W, DALI

\*Due to the constancy of product development,  
we reserve the right to alter all specification  
without prior notice.

Unilamp Co., Ltd.  
461 Ramintra Road, Kannayao, Bangkok 10230 Thailand  
Tel : +66[0]2 943 2420-1, +66[0]2 946 4170-1  
Fax : +66[0]2 943 2419  
online@unilamp.co.th  
www.unilamp.co.th