

ACQUA

ACQUA

UNDERWATER

 **Unilamp**

LAST UPDATE: 26-11-2024



A family of recessed and surface mounted under water luminaires which are commonly used to illuminate swimming pools, decorative pools and fountains. Accessories include several watertight connecting devices. ACQUA1 utilizes high power LED in 2700K, 3000K or 4000K and high quality optical lenses offering narrow, medium, wide and elliptical beam. Version with GU5.3 lamp holder for MR16 Led retrofit lamps is also available. To avoid installation issues and add another level of safety, ACQUA1 is pre-wired and is fitted with an anti-condensation device. To avoid over-heating of the luminaire body, ACQUA1 must be operated in a submersible state at all time. The marine grade 316 stainless steel body guarantees corrosion free appearance throughout the life time. We highly recommend that the luminaire lay out should be considered during specifying and planning processes. Installation work must be carried out under national safety regulations.

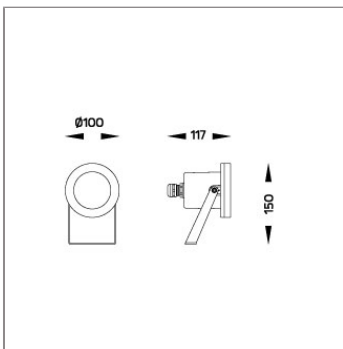

Technical Data



Ordering Code :	7417-B-2-583-92
Lamp :	LED
Beam :	29°
CCT :	2700 K
CRI :	CRI >80
SDCM :	SDCM = 3
Lamp Lumen :	1290 lm
Luminaire Lumen :	920 lm
Lamp Wattage :	12 W(24Vdc)
Luminaire Wattage :	12 W
Efficacy :	61 lm/W
Ambient Temperature :	50°C
Lumen Maintenance	L70B10 >66,000 h
Controller :	Remote
Input Voltage :	24Vdc
Net Weight :	- kg.

Ordering code guide

XXXX-X-X-XXX-XX

A B C D E

- A Product Code
- B Reflector
- C Electrical Component
- D Lamp
- E Color



Icon definition

*Due to the constancy of product development, we reserve the right to alter all specification without prior notice.

Unilamp Co., Ltd.
461 Ramintra Road, Kannayao, Bangkok 10230 Thailand
Tel : +66(O)2 943 2420-1, +66(O)2 946 4170-1
Fax : +66(O)2 943 2419
online@unilamp.co.th
www.unilamp.co.th

ACQUA

ACQUA

UNDERWATER



LAST UPDATE: 26-11-2024

Specification

IEC Standard	IEC 60598-1 General Requirement IEC 60598-2-18 Luminaires for Swimming Pools
Protection	IP68 Class III
IK Rating	Protection against mechanical impact IK10 on body and IK09 on optical part.
Luminaires Body Housing	Supreme corrosion proof Under Water grade Stainless Steel. Full body polish finished.
Diffuser	Impact resistant safety tempered glass cover. Able to withstand the temperature up to 250°C.
Lens	Molded PC lens from renowned manufacturers in various light distribution patterns.
Adjustable Optic	Adjustable aiming unit through graduated scale.
Gasket	Post-cured treated silicone gasket. Temperature and weather resistant. Working temperature -40°C to +200°C.
External Screws	Marine grade 316 stainless steel screw.
Cable Entry	Cable entry protected by M16 cable gland. To be used with H05RN-F/ H07RN-F cable with 5-10mm. diameter.
Led	High efficiency LED module utilized chips from world renowned manufacturer. Assembled on MCPCB and mounted on to heat conductive material.
Driver	Driver is not included and has to be ordered separately.
Pre-Wire Cable	Pre-wired with 2x1.0 sqmm. H07RN-F neoprene cable. IMQ approved.
Caution	Installation work has to be carried on according to the enclosed installation manual. The water drainage system must be tested to ensure that it is working sufficiency and efficiency.

Light Distribution

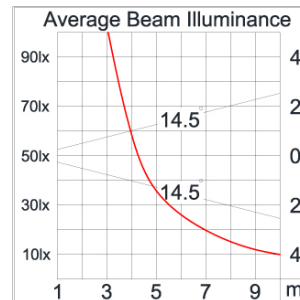
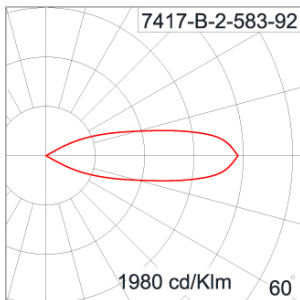

*Due to the constancy of product development, we reserve the right to alter all specification without prior notice.

Unilamp Co., Ltd.
461 Ramintra Road, Kannayao, Bangkok 10230 Thailand
Tel : +66(0)2 943 2420-1, +66(0)2 946 4170-1
Fax : +66(0)2 943 2419
online@unilamp.co.th
www.unilamp.co.th

ACQUA

ACQUA

UNDERWATER

 **Unilamp**

LAST UPDATE: 26-11-2024

Accessories



Ordering Code:
AUN-CON-0003-00
IP68 Connector, cable
diameter 8-10mm,
gel-filled for through wiring



Ordering Code:
AUN-CON-0004-00
IP68 Connector, cable
diameter 8-10mm,
gel-filled

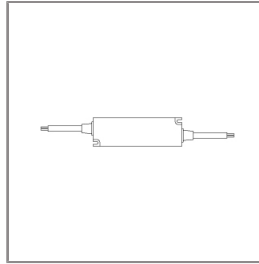

Ordering Code:
AUN-DRG-0118-00
LED constant voltage
driver, 24VDC, 30W



Ordering Code:
AUN-DRG-0027-00
LED constant voltage
driver, 24VDC, 72W

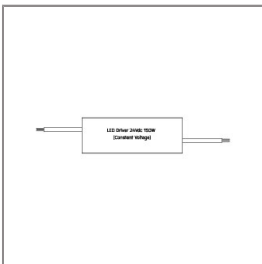

Ordering Code:
AUN-DRG-0011-00
LED constant voltage
driver, 24VDC, 150W

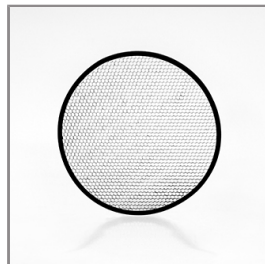

Ordering Code:
AUN-GSH-0008-00
Honeycomb louver, LED,
pre-assembly from factory

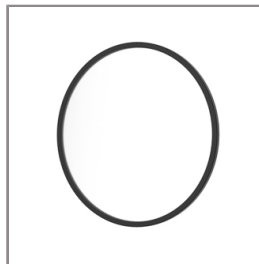

Ordering Code:
AUN-SOF-0022-00
Softening filter, LED,
pre-assembly from factory

*Due to the constancy of product development,
we reserve the right to alter all specification
without prior notice.

Unilamp Co., Ltd.
461 Ramintra Road, Kannayao, Bangkok 10230 Thailand
Tel : +66(0)2 943 2420-1, +66(0)2 946 4170-1
Fax : +66(0)2 943 2419
online@unilamp.co.th
www.unilamp.co.th