

VAREE

VAREE

UNDERWATER



LAST UPDATE: 19-03-2025



VAREE A family of LED underwater luminaires that is suitable to be installed on the ground, recess in a concrete wall or surface mounted. Operating with high lumen output LED from 2700K, 3000K, 4000K and RGBW with high CRI in 3 steps SDCM. VAREE is designed to illuminate swimming pools, decorative pools, fountains and any submersible application. A wide range of beam angles including Narrow, Medium, Wide and Elliptical beams as well as Asymmetric floor washer. VAREE is pre-wired with underwater cable and internally potted to prevent humidity and condensation. To avoid over-heating, VAREE is equipped with a thermal cut-off device thus the luminaire has to be submerged at all time. The marine grade 316 stainless steel material and advance polymer guarantees corrosion free appearance through out the life time. We highly recommend that the luminaire lay out should be considered during specifying and planning processes. Installation work must be carried out under national safety regulations.

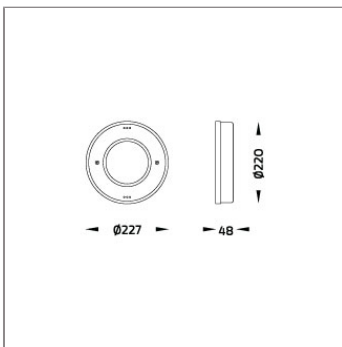

Technical Data



Ordering Code :	7414-7-2-897-92
Lamp :	LED
Beam :	46°
CCT :	3000 K
CRI :	CRI >80
SDCM :	SDCM = 3
Lamp Lumen :	2880 lm
Luminaire Lumen :	1540 lm
Lamp Wattage :	25 W[24Vdc]
Luminaire Wattage :	25 W
Efficacy :	61 lm/W
Ambient Temperature :	50°C
Lumen Maintenance	L70B10 >66,000 h
Controller :	Remote
Input Voltage :	24Vdc
Net Weight :	1.40 kg.

Ordering code guide

XXXX-X-X-XXX-XX
A B C D E

- A Product Code
- B Reflector
- C Electrical Component
- D Lamp
- E Color



Icon definition

*Due to the constancy of product development, we reserve the right to alter all specification without prior notice.

Unilamp Co., Ltd.
461 Ramintra Road, Kannayao, Bangkok 10230 Thailand
Tel : +66[0]2 943 2420-1, +66[0]2 946 4170-1
Fax : +66[0]2 943 2419
online@unilamp.co.th
www.unilamp.co.th

Specification

IEC Standard	IEC 60598-1 General Requirement IEC 60598-2-18 Luminaires for Swimming Pools
Protection	IP68 Class III
IK Rating	Protection against mechanical impact IK05 on body and IK07 optical part.
Luminaires Body Housing	Supreme corrosion proof Under Water grade Stainless Steel. Injected GFR Engineering Polymer body component.
Diffuser	Impact resistant safety tempered glass cover. Able to withstand the temperature up to 250°C.
Lens	Molded PC lens from renowned manufacturers in various light distribution patterns.
Gasket	Post-cured treated silicone gasket. Temperature and weather resistant. Working temperature -40°C to +200°C.
External Screws	Marine grade 316 stainless steel screw.
Cable Entry	Cable entry protected by M12 cable gland. To be used with H05RN-F/ H07RN-F cable with 4-7mm. diameter.
Led	High efficiency LED module utilized chips from world renowned manufacturer. Assembled on MCPCB and mounted on to heat conductive material.
Driver	Driver is not included and has to be ordered separately.
Internal Wire	Tinned copper conductor with PTFE insulated internal wire. IMQ approved. Working temperature -40°C to +250°C.
Pre-Wire Cable	Pre-wired with 2x1.0 sqmm. H05RN-F neoprene cable. IMQ approved.
Caution	Installation work has to be carried on according to the enclosed installation manual. To avoid over-heating, this luminaire has to use under water only.

Light Distribution

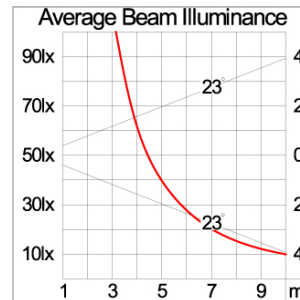
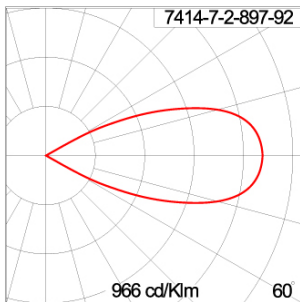

Accessories



Ordering Code:
AUN-DRG-0011-00
LED constant voltage
driver, 24VDC, 150W

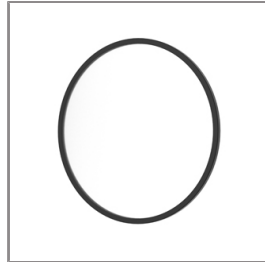

Ordering Code:
AUN-SOF-0032-00
Softening filter, LED,
pre-assembly from factory



Ordering Code:
AUN-CON-0024-00
IP68 Connector, cable
diameter 4.8-6mm,
gel-filled

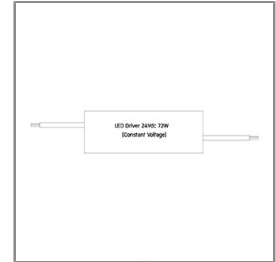

Ordering Code:
AUN-DRG-0027-00
LED constant voltage
driver, 24VDC, 72W

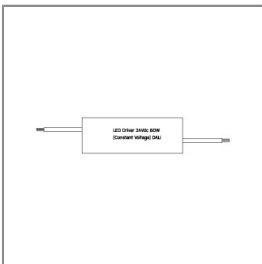

Ordering Code:
AUN-DRG-0100-00
LED constant voltage
driver, 24VDC, 60W, DALI

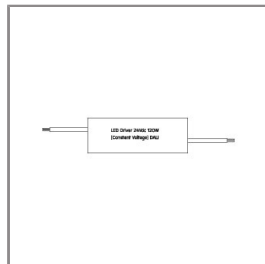

Ordering Code:
AUN-DRG-0101-00
LED constant voltage
driver, 24VDC, 120W, DALI