

CORE

MINI CORE

CEILING RECESSED



LAST UPDATE: 24-02-2025

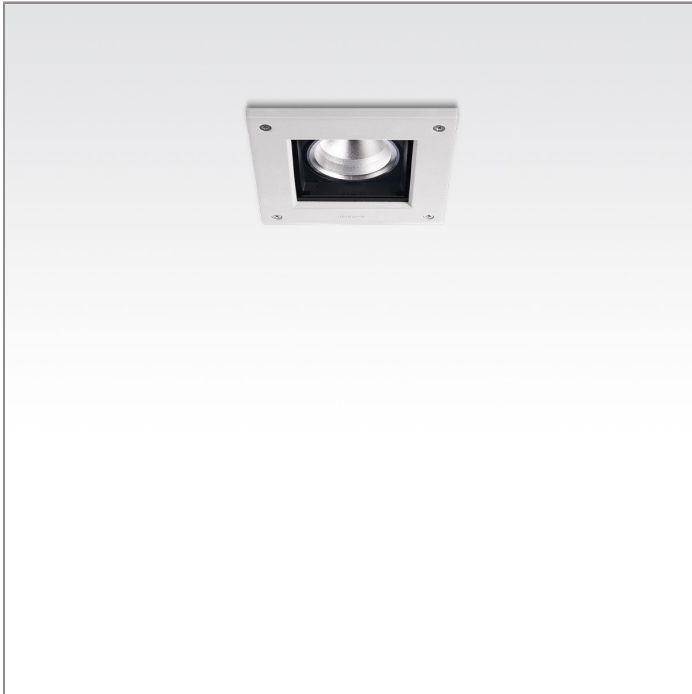

Characterized by clean and clear-cut lines CORE is a family of square wall light, ceiling light, bollard and pole lights. CORE is available in two sizes and equipped with COB LED/ High Power LED in three color temperatures with exceptional color consistency. It is also available in HID version as well as with E27 holder for Led Retrofit lamps. The computer-aided-design of the parabolic reflector provides a quality light distribution. The housing is dust and water protected through the extensive engineering design and testing. CORE is recommended to illuminate columns, facades, walkways, parks and various architectural design works. The pole lights give a great level of downward light with symmetric wide beam, asymmetric forward throw or side throw light distributions.

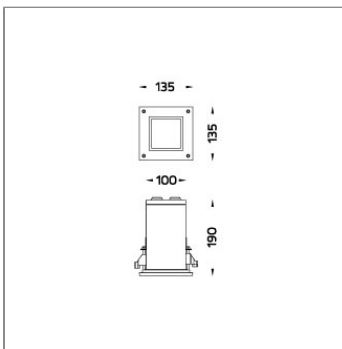

Technical Data



Ordering Code :	7332-A-3-904-XX
Lamp :	LED
Beam :	13°
CCT :	4000 K
CRI :	CRI >80
SDCM :	SDCM = 3
Lamp Lumen :	1940 lm
Luminaire Lumen :	1740 lm
Lamp Wattage :	12 W
Luminaire Wattage :	14 W
Efficacy :	124 lm/W
Ambient Temperature :	50°C
Lumen Maintenance	L70B10 >60,000 h
Controller :	On-Off
Input Voltage :	220-240Vac 50/60Hz
Net Weight :	- kg.

Ordering code guide

XXXX-X-X-XXX-XX

A B C D E

- A Product Code
- B Reflector
- C Electrical Component
- D Lamp
- E Color



Icon definition

*Due to the constancy of product development, we reserve the right to alter all specification without prior notice.

Unilamp Co., Ltd.
461 Ramintra Road, Kannayao, Bangkok 10230 Thailand
Tel : +66(0)2 943 2420-1, +66(0)2 946 4170-1
Fax : +66(0)2 943 2419
online@unilamp.co.th
www.unilamp.co.th

CORE

MINI CORE

CEILING RECESSED



LAST UPDATE: 24-02-2025

Specification

IEC Standard	IEC 60598-1 General Requirement IEC 60598-2-2 Recessed Luminaires										
Protection	IP65 Class I										
IK Rating	Protection against mechanical impact IK10 on body and IK09 on optical part.										
Luminaires Body Housing	High-pressure die cast aluminum alloy body and components. Extruded aluminum 56063 alloy body with low copper content.										
Coating Process	Nano Ceramic surface conversion, resistant to corrosive environment. Luminaire primarily coated with epoxy resin and top coated with UV stabilized polyester powder and cured in digital temperature controlled chamber at 200°C.										
Diffuser	Impact resistant safety tempered glass cover. Able to withstand the temperature up to 250°C.										
Reflector	High performance anodized spun aluminum reflector.										
Gasket	Post-cured treated silicone gasket. Temperature and weather resistant. Working temperature -40°C to +200°C.										
External Screws	External screws are in stainless steel with protection grease.										
Cable Entry	Cable entry protected by weather proof grommet. To be used with HO5RN-F/ HO7RN-F cable with 6-13mm. diameter.										
Led	High efficiency LED module in COB technology. Assembled on MCPCB and mounted on to heat conductive material.										
Driver	High quality constant current LED driver. Conform to safety standard and electromagnetic compatibility standard.										
Internal Wire	Tinned copper conductor with silicone insulated internal wire. IMQ approved. Working temperature -40°C to +180°C.										
Terminal Block	Terminal block in GFR PA6.6 for cable with cross section up to 2.5 sqmm. VDE approved. Class1 luminaire provided with the earth connection.										
Caution	Installation work has to be carried on according to the enclosed installation manual.										
Color	<table><tr><td></td><td>Black O1</td></tr><tr><td></td><td>Graphite O2</td></tr><tr><td></td><td>Dark Grey O3</td></tr><tr><td></td><td>Aluminum Silver O4</td></tr><tr><td></td><td>White O6</td></tr></table>		Black O1		Graphite O2		Dark Grey O3		Aluminum Silver O4		White O6
	Black O1										
	Graphite O2										
	Dark Grey O3										
	Aluminum Silver O4										
	White O6										

Light Distribution

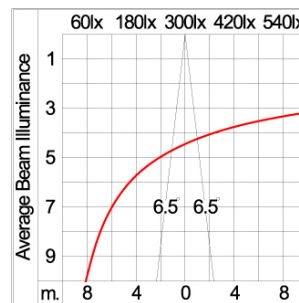
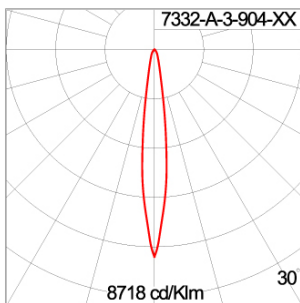

*Due to the constancy of product development, we reserve the right to alter all specification without prior notice.

Unilamp Co., Ltd.
461 Ramintra Road, Kannayao, Bangkok 10230 Thailand
Tel : +66(0)2 943 2420-1, +66(0)2 946 4170-1
Fax : +66(0)2 943 2419
online@unilamp.co.th
www.unilamp.co.th

CORE

MINI CORE

CEILING RECESSED



LAST UPDATE: 24-02-2025

Accessories



Ordering Code:
AUN-CAB-0002-00
Cable H07RN-F 3x1sqmm,
L= 2000, with UniBlock
anti-humidity kit,
pre-assembly from factory



Ordering Code:
AUN-CAB-0004-00
Cable H07RN-F 3x1sqmm,
L= 500, with UniBlock
anti-humidity kit,
pre-assembly from factory

*Due to the constancy of product development,
we reserve the right to alter all specification
without prior notice.

Unilamp Co., Ltd.
461 Ramintra Road, Kannayao, Bangkok 10230 Thailand
Tel : +66[0]2 943 2420-1, +66[0]2 946 4170-1
Fax : +66[0]2 943 2419
online@unilamp.co.th
www.unilamp.co.th