

CORE

MAXI CORE

CEILING RECESSED



LAST UPDATE: 24-02-2025



Characterized by clean and clear-cut lines CORE is a family of square wall light, ceiling light, bollard and pole lights. CORE is available in two sizes and equipped with COB LED/ High Power LED in three color temperatures with exceptional color consistency. It is also available in HID version as well as with E27 holder for Led Retrofit lamps. The computer-aided-design of the parabolic reflector provides a quality light distribution. The housing is dust and water protected through the extensive engineering design and testing. CORE is recommended to illuminate columns, facades, walkways, parks and various architectural design works. The pole lights give a great level of downward light with symmetric wide beam, asymmetric forward throw or side throw light distributions.

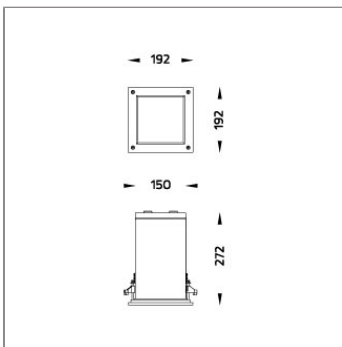

Technical Data



| | |
|-----------------------|--------------------|
| Ordering Code : | 7322-7-4-506-XX |
| Lamp : | LED |
| Beam : | 48° |
| CCT : | 2700 K |
| CRI : | CRI >80 |
| SDCM : | SDCM = 3 |
| Lamp Lumen : | 3160 lm |
| Luminaire Lumen : | 2650 lm |
| Lamp Wattage : | 23 W |
| Luminaire Wattage : | 26 W |
| Efficacy : | 101 lm/W |
| Ambient Temperature : | 50°C |
| Lumen Maintenance | L70B10 >90,000 h |
| Controller : | DIM 1-10V |
| Input Voltage : | 220-240Vac 50/60Hz |
| Net Weight : | 3.80 kg. |

Ordering code guide

XXXX-X-X-XXX-XX
A B C D E

- A Product Code
- B Reflector
- C Electrical Component
- D Lamp
- E Color



Icon definition

*Due to the constancy of product development, we reserve the right to alter all specification without prior notice.

Unilamp Co., Ltd.
461 Ramintra Road, Kannayao, Bangkok 10230 Thailand
Tel : +66(0)2 943 2420-1, +66(0)2 946 4170-1
Fax : +66(0)2 943 2419
online@unilamp.co.th
www.unilamp.co.th

CORE

MAXI CORE

CEILING RECESSED



LAST UPDATE: 24-02-2025

Specification

| | | | | | | | | | | | |
|-------------------------|---|--|----------|--|-------------|--|--------------|--|--------------------|--|----------|
| IEC Standard | IEC 60598-1 General Requirement IEC 60598-2-2 Recessed Luminaires | | | | | | | | | | |
| Protection | IP65 Class I | | | | | | | | | | |
| IK Rating | Protection against mechanical impact IK08 on body and IK06 optical part. | | | | | | | | | | |
| Luminaires Body Housing | High-pressure die cast aluminum alloy body and components. Extruded aluminum 56063 alloy body with low copper content. | | | | | | | | | | |
| Coating Process | Nano Ceramic surface conversion, resistant to corrosive environment. Luminaire primarily coated with epoxy resin and top coated with UV stabilized polyester powder and cured in digital temperature controlled chamber at 200°C. | | | | | | | | | | |
| Diffuser | Impact resistant safety tempered glass cover. Able to withstand the temperature up to 250°C. | | | | | | | | | | |
| Reflector | High performance metallized reflector. | | | | | | | | | | |
| Gasket | Post-cured treated silicone gasket. Temperature and weather resistant. Working temperature -40°C to +200°C. | | | | | | | | | | |
| External Screws | External screws are in stainless steel with protection grease. | | | | | | | | | | |
| Cable Entry | Cable entry protected by weather proof grommet. To be used with HO5RN-F/ HO7RN-F cable with 6-13mm. diameter. | | | | | | | | | | |
| Led | High efficiency LED module in COB technology. Assembled on MCPCB and mounted on to heat conductive material. | | | | | | | | | | |
| Driver | High quality Dimmable Driver [1-10V] in constant current. Conform to applicable safety standards and electromagnetic compatibility. | | | | | | | | | | |
| Internal Wire | Tinned copper conductor with silicone insulated internal wire. IMQ approved. Working temperature -40°C to +180°C. | | | | | | | | | | |
| Terminal Block | Terminal block in GFR PA6.6 for cable with cross section up to 2.5 sqmm. VDE approved. Class1 luminaire provided with the earth connection. | | | | | | | | | | |
| Caution | Installation work has to be carried on according to the enclosed installation manual. | | | | | | | | | | |
| Color | <table><tr><td></td><td>Black O1</td></tr><tr><td></td><td>Graphite O2</td></tr><tr><td></td><td>Dark Grey O3</td></tr><tr><td></td><td>Aluminum Silver O4</td></tr><tr><td></td><td>White O6</td></tr></table> | | Black O1 | | Graphite O2 | | Dark Grey O3 | | Aluminum Silver O4 | | White O6 |
| | Black O1 | | | | | | | | | | |
| | Graphite O2 | | | | | | | | | | |
| | Dark Grey O3 | | | | | | | | | | |
| | Aluminum Silver O4 | | | | | | | | | | |
| | White O6 | | | | | | | | | | |

Light Distribution

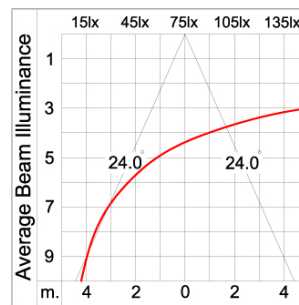
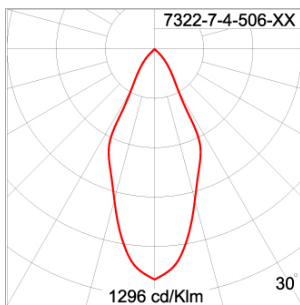

*Due to the constancy of product development, we reserve the right to alter all specification without prior notice.

Unilamp Co., Ltd.
461 Ramintra Road, Kannayao, Bangkok 10230 Thailand
Tel : +66[0]2 943 2420-1, +66[0]2 946 4170-1
Fax : +66[0]2 943 2419
online@unilamp.co.th
www.unilamp.co.th

CORE

MAXI CORE

CEILING RECESSED



LAST UPDATE: 24-02-2025

Accessories

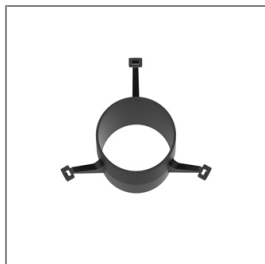

Ordering Code:
AUN-GHS-0025-00
Glare shield ring, COB



Ordering Code:
AUN-CAB-0003-00
Cable 3x1sqmm and
2x0.35sqmm, L= 2000,
with UniBlock
anti-humidity kit,
pre-assembly from factory

*Due to the constancy of product development,
we reserve the right to alter all specification
without prior notice.

Unilamp Co., Ltd.
461 Ramintra Road, Kannayao, Bangkok 10230 Thailand
Tel : +66(0)2 943 2420-1, +66(0)2 946 4170-1
Fax : +66(0)2 943 2419
online@unilamp.co.th
www.unilamp.co.th