

# CORE

## MAXI CORE

### CEILING RECESSED



LAST UPDATE: 14-05-2024



Characterized by clean and clear-cut lines CORE is a family of square wall light, ceiling light, bollard and pole lights. CORE is available in two sizes and equipped with COB LED/ High Power LED in three color temperatures with exceptional color consistency. It is also available in HID version as well as with E27 holder for Led Retrofit lamps. The computer-aided-design of the parabolic reflector provides a quality light distribution. The housing is dust and water protected through the extensive engineering design and testing. CORE is recommended to illuminate columns, facades, walkways, parks and various architectural design works. The pole lights give a great level of downward light with symmetric wide beam, asymmetric forward throw or side throw light distributions.

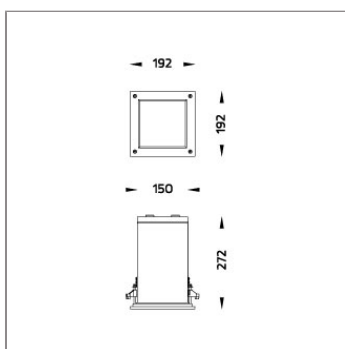

## Technical Data



Ordering Code :	7322-5-3-887-XX
Lamp :	LED
Beam :	12°
CCT :	3000 K
CRI :	CRI >80
SDCM :	SDCM = 3
Lamp Lumen :	3300 lm
Luminaire Lumen :	3300 lm
Lamp Wattage :	23 W
Luminaire Wattage :	26 W
Efficacy :	126 lm/W
Ambient Temperature :	50°C
Lumen Maintenance	L70B10 >90,000 h
Controller :	On-Off
Input Voltage :	220-240Vac 50/60Hz
Net Weight :	3.80 kg.

### Ordering code guide

XXXX-X-X-XXX-XX

A B C D E

- A Product Code
- B Reflector
- C Electrical Component
- D Lamp
- E Color



Icon definition

\*Due to the constancy of product development, we reserve the right to alter all specification without prior notice.

Unilamp Co., Ltd.  
461 Ramintra Road, Kannayao, Bangkok 10230 Thailand  
Tel : +66(0)2 943 2420-1, +66(0)2 946 4170-1  
Fax : +66(0)2 943 2419  
online@unilamp.co.th  
www.unilamp.co.th

# CORE

## MAXI CORE

### CEILING RECESSED



LAST UPDATE: 14-05-2024

#### Specification

IEC Standard	IEC 60598-1 General Requirement IEC 60598-2-2 Recessed Luminaires												
Protection	IP65 Class I												
IK Rating	Protection against mechanical impact IK08 on body and IK06 optical part.												
Luminaires Body Housing	High-pressure die cast aluminum alloy body and components. Extruded aluminum 56063 alloy body with low copper content.												
Coating Process	Nano Ceramic surface conversion, resistant to corrosive environment. Luminaire primarily coated with epoxy resin and top coated with UV stabilized polyester powder and cured in digital temperature controlled chamber at 200°C.												
Diffuser	Impact resistant safety tempered glass cover. Able to withstand the temperature up to 250°C.												
Reflector	High performance metallized reflector.												
Gasket	Post-cured treated silicone gasket. Temperature and weather resistant. Working temperature -40°C to +200°C.												
External Screws	External screws are in stainless steel with protection grease.												
Cable Entry	Cable entry protected by weather proof grommet. To be used with HO5RN-F/ HO7RN-F cable with 6-13mm. diameter.												
Led	High efficiency LED module in COB technology. Assembled on MCPCB and mounted on to heat conductive material.												
Driver	High quality constant current LED driver. Conform to safety standard and electromagnetic compatibility standard.												
Internal Wire	Tinned copper conductor with silicone insulated internal wire. IMQ approved. Working temperature -40°C to +180°C.												
Terminal Block	Terminal block in GFR PA6.6 for cable with cross section up to 2.5 sqmm. VDE approved. Class1 luminaire provided with the earth connection.												
Caution	Installation work has to be carried on according to the enclosed installation manual.												
Color	<table><tr><td></td><td>Black O1</td></tr><tr><td></td><td>Graphite O2</td></tr><tr><td></td><td>Dark Grey O3</td></tr><tr><td></td><td>Aluminum Silver O4</td></tr><tr><td></td><td>White O6</td></tr><tr><td></td><td>Wooden Brown O7</td></tr></table>		Black O1		Graphite O2		Dark Grey O3		Aluminum Silver O4		White O6		Wooden Brown O7
	Black O1												
	Graphite O2												
	Dark Grey O3												
	Aluminum Silver O4												
	White O6												
	Wooden Brown O7												

#### Light Distribution

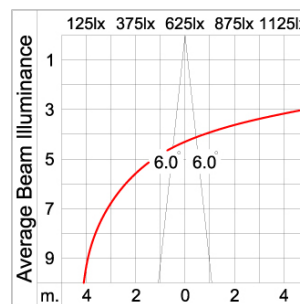
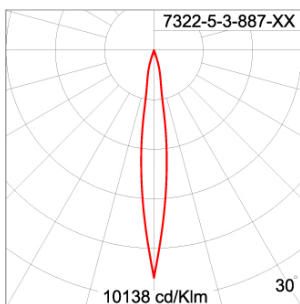

\*Due to the constancy of product development,  
we reserve the right to alter all specification  
without prior notice.

Unilamp Co., Ltd.  
461 Ramintra Road, Kannayao, Bangkok 10230 Thailand  
Tel : +66(0)2 943 2420-1, +66(0)2 946 4170-1  
Fax : +66(0)2 943 2419  
online@unilamp.co.th  
www.unilamp.co.th

# CORE

## MAXI CORE

### CEILING RECESSED



LAST UPDATE: 14-05-2024

#### Accessories



Ordering Code:  
AUN-GHS-0025-00  
Glare Shield Ring for COB



Ordering Code:  
AUN-CAB-0002-00  
Cable H07RN-F 3x1sqmm  
length 2000 mm with  
anti-humidity kit.  
(pre-assembled from  
factory)



Ordering Code:  
AUN-CAB-0004-00  
Cable H07RN-F 3x1sqmm  
length 500mm. with  
anti-humidity  
kit.(pre-assembled from  
factory)

\*Due to the constancy of product development,  
we reserve the right to alter all specification  
without prior notice.

Unilamp Co., Ltd.  
461 Ramintra Road, Kannayao, Bangkok 10230 Thailand  
Tel : +66[0]2 943 2420-1, +66[0]2 946 4170-1  
Fax : +66[0]2 943 2419  
online@unilamp.co.th  
www.unilamp.co.th