

ANDROMEDA

MINI ANDROMEDA – DS

POLE MOUNTED



LAST UPDATE: 10-05-2024



ANDROMEDA is a round-shaped robust outdoor luminaire for public space illumination. The housing is made of corrosion resistant LM6 die-cast aluminium and is passivated with Nano Ceramic layer then coated with primer and super durable Polyester powder paint. ANDROMEDA is equipped with high power LEDs with high CRI in 3000K or 4000K color temperature with 3 SDCM. It offers perfectly engineered light distributions for various lighting applications such as area lighting, car parks, open spaces and façade lighting. ANDROMEDA fulfills the dark sky requirement and is free from light pollution. The heat management has been delicately designed and tested under high ambient thermal condition. An integrated scale allows precise aiming of the luminaire to achieve the desired illumination level. The recommended mounting height is between 4 – 8 meters depending on the application. Available as an option are Aluminium Poles, Galvanized steel poles and anchorage unit for concrete foundations.

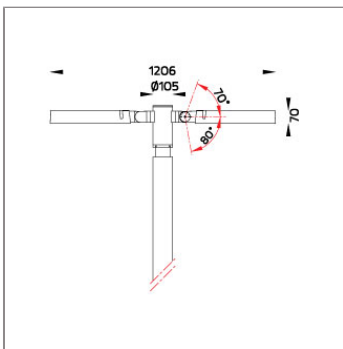

Technical Data



Ordering Code :	7298-3-3-863-XX
Lamp :	LED
Beam :	95°/20°
CCT :	3000 K
CRI :	CRI >80
SDCM :	SDCM = 3
Lamp Lumen :	2x7480 lm
Luminaire Lumen :	12060 lm
Lamp Wattage :	2x57 W
Luminaire Wattage :	124 W
Efficacy :	97 lm/W
Ambient Temperature :	50°C
Lumen Maintenance	L70B10 >66,000 h
Controller :	On-Off
Input Voltage :	220-240Vac 50/60Hz
Net Weight :	18.10 kg.

Ordering code guide

XXXX-X-X-XXX-XX
A B C D E

- A Product Code
- B Reflector
- C Electrical Component
- D Lamp
- E Color



Icon definition

*Due to the constancy of product development, we reserve the right to alter all specification without prior notice.

Unilamp Co., Ltd.
461 Ramintra Road, Kannayao, Bangkok 10230 Thailand
Tel : +66(0)2 943 2420-1, +66(0)2 946 4170-1
Fax : +66(0)2 943 2419
online@unilamp.co.th
www.unilamp.co.th

ANDROMEDA

MINI ANDROMEDA – DS

POLE MOUNTED



LAST UPDATE: 10-05-2024

Specification

IEC Standard	IEC 60598-1 General Requirement IEC 60598-2-1 Fixed Luminaires												
Protection	IP65 Class I												
IK Rating	Protection against mechanical impact IK10 on body and optical part.												
Luminaires Body Housing	High-pressure die cast aluminum alloy body and components.												
Coating Process	Nano Ceramic surface conversion, resistant to corrosive environment. Luminaire primarily coated with epoxy resin and top coated with UV stabilized polyester powder and cured in digital temperature controlled chamber at 200°C.												
Diffuser	Impact resistant safety tempered glass cover. Able to withstand the temperature up to 250°C.												
Lens	Molded PC lens from renowned manufacturers in various light distribution patterns.												
Adjustable Optic	Adjustable aiming unit through graduated scale.												
Gasket	Post-cured treated silicone gasket. Temperature and weather resistant. Working temperature -40°C to +200°C.												
External Screws	External screws are in stainless steel with protection grease.												
Cable Entry	Cable entry protected by M20 cable gland. To be used with H05RN-F/ H07RN-F cable with 7-13mm. diameter.												
Led	High efficiency LED module utilized chips from world renowned manufacturer. Assembled on MCPCB and mounted on to heat conductive material.												
Driver	High quality constant current LED driver. Conform to safety standard and electromagnetic compatibility standard.												
Internal Wire	Tinned copper conductor with silicone insulated internal wire. IMQ approved. Working temperature -40°C to +180°C.												
Terminal Block	Terminal block in GFR PA6.6 for cable with cross section up to 2.5 sqmm. VDE approved. Class1 luminaire provided with the earth connection.												
Pre-Wire Cable	Pre-wired with 3x1.0 sqmm. H07RN-F neoprene cable. IMQ approved.												
Caution	Installation work has to be carried on according to the enclosed installation manual.												
Color	<table><tr><td></td><td>Black O1</td></tr><tr><td></td><td>Graphite O2</td></tr><tr><td></td><td>Dark Grey O3</td></tr><tr><td></td><td>Aluminum Silver O4</td></tr><tr><td></td><td>White O6</td></tr><tr><td></td><td>Wooden Brown O7</td></tr></table>		Black O1		Graphite O2		Dark Grey O3		Aluminum Silver O4		White O6		Wooden Brown O7
	Black O1												
	Graphite O2												
	Dark Grey O3												
	Aluminum Silver O4												
	White O6												
	Wooden Brown O7												

Light Distribution

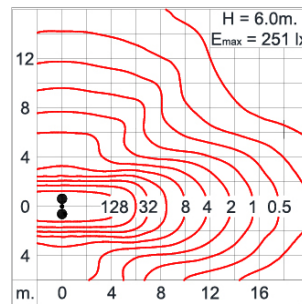
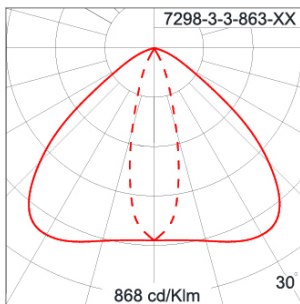

*Due to the constancy of product development, we reserve the right to alter all specification without prior notice.

Unilamp Co., Ltd.
461 Ramintra Road, Kannayao, Bangkok 10230 Thailand
Tel : +66(0)2 943 2420-1, +66(0)2 946 4170-1
Fax : +66(0)2 943 2419
online@unilamp.co.th
www.unilamp.co.th

ANDROMEDA

MINI ANDROMEDA – DS

POLE MOUNTED



LAST UPDATE: 10-05-2024

Bug Report

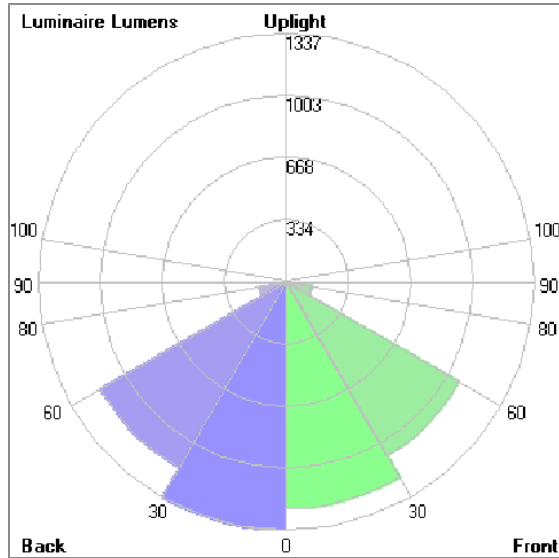

Lum. Classification System [LCS]

LCS	Zone	%Lumens	%Lamp	%Lum
FL	[0-30]	1219.9	16.3	24.0
FM	[30-60]	1077.9	14.4	21.2
FH	[60-80]	140.2	1.9	2.8
FVH	[80-90]	3.0	0.0	0.1
BL	[0-30]	1336.7	17.9	26.3
BM	[30-60]	1155.9	15.5	22.7
BH	[60-80]	149.0	2.0	2.9
BVH	[80-90]	4.0	0.1	0.1
UL	[90-100]	< 0.05	0.0	0.0
UH	[100-180]	0.0	0.0	0.0
Total		5086.6	68.1	100.0
BUG Rating		B3-U1-G1		

*Due to the constancy of product development, we reserve the right to alter all specification without prior notice.

Unilamp Co., Ltd.
461 Ramintra Road, Kannayao, Bangkok 10230 Thailand
Tel : +66[0]2 943 2420-1, +66[0]2 946 4170-1
Fax : +66[0]2 943 2419
online@unilamp.co.th
www.unilamp.co.th

ANDROMEDA

MINI ANDROMEDA – DS

POLE MOUNTED



LAST UPDATE: 10-05-2024

Accessories



Ordering Code:

ALUMINUM-POLE-MINI-ANDROMEDA

Please contact Sales
Representative



Ordering Code:

STEEL-POLE-MINI-ANDROMEDA

Please contact Sales
Representative



Ordering Code:

AUN-ACB-0009-00

Anchor Bolt Kit for
Galvanized Steel Pole. [for
pole Diameter 114mm. and
Diameter 114&140mm.]

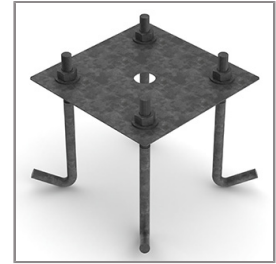

Ordering Code:

AUN-ACB-0008-00

Anchor Bolt Kit for
Galvanized Steel Pole. [for
Diameter 102mm. and
151x102mm.]



Ordering Code:

AUN-ACB-0005-00

Anchor Bolt Kit for
Aluminium Pole

*Due to the constancy of product development,
we reserve the right to alter all specification
without prior notice.

Unilamp Co., Ltd.
461 Ramintra Road, Kannayao, Bangkok 10230 Thailand
Tel : +66[0]2 943 2420-1, +66[0]2 946 4170-1
Fax : +66[0]2 943 2419
online@unilamp.co.th
www.unilamp.co.th