

# ATHLON

ATHLON OPTIC – DS  
POLE MOUNTED



LAST UPDATE: 13-05-2024



ATHLON family is functional mini spotlight/ floodlight and area light. The slim and clean design of Athlon allows a hidden installation. Athlon is designed for a streamlined time effective installation. Alanod Miro reflectors used in this luminaire are designed by Photopia high-end lighting engineering software. ATHLON Optic with tight beam control utilizes selected lenses from world-renowned manufacturers. The family is available with symmetric, asymmetric, bisymmetric, elliptical, forward throw and side throw light distributions. The broad range of accessories such as a ground spike, tree strap, outrigger arm and pole clamp makes it a dynamic floodlight choice. The graduated scale provides accuracy of the light distribution on the illuminated surface. ATHLON is suitable to light up small to medium sized objects or areas such as signage boards, ceiling, building facades, parks etc.

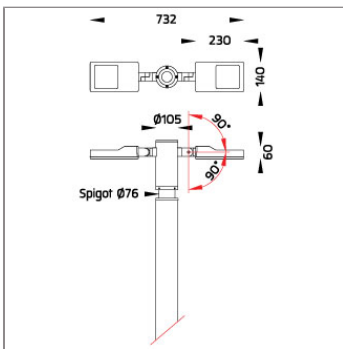

## Technical Data



Ordering Code :	7259-C-3-897-XX
Lamp :	LED
Beam :	46°
CCT :	3000 K
CRI :	CRI >80
SDCM :	SDCM = 3
Lamp Lumen :	2x2880 lm
Luminaire Lumen :	4480 lm
Lamp Wattage :	2x25 W
Luminaire Wattage :	56 W
Efficacy :	80 lm/W
Ambient Temperature :	40°C
Lumen Maintenance	L70B10 >66,000 h
Controller :	On-Off
Input Voltage :	220-240Vac 50/60Hz
Net Weight :	6.40 kg.

### Ordering code guide

XXXX-X-X-XXX-XX  
A B C D E

- A Product Code
- B Reflector
- C Electrical Component
- D Lamp
- E Color





















Icon definition

\*Due to the constancy of product development, we reserve the right to alter all specification without prior notice.

Unilamp Co., Ltd.  
461 Ramintra Road, Kannayao, Bangkok 10230 Thailand  
Tel : +66(0)2 943 2420-1, +66(0)2 946 4170-1  
Fax : +66(0)2 943 2419  
online@unilamp.co.th  
www.unilamp.co.th

### Specification

IEC Standard	IEC 60598-1 General Requirement IEC 60598-2-1 Fixed Luminaires												
Protection	IP66 Class I												
IK Rating	Protection against mechanical impact IK08 on body and IK07 optical part.												
Luminaires Body Housing	High-pressure die cast aluminum alloy body and components. Extruded Aluminum S6063 alloy body with low copper content.												
Coating Process	Nano Ceramic surface conversion, resistant to corrosive environment. Luminaire primarily coated with epoxy resin and top coated with UV stabilized polyester powder and cured in digital temperature controlled chamber at 200°C.												
Diffuser	Impact resistant safety tempered glass cover. Able to withstand the temperature up to 250°C.												
Lens	Molded PC lens from renowned manufacturers in various light distribution patterns.												
Adjustable Optic	Adjustable aiming unit through graduated scale.												
Gasket	Post-cured treated silicone gasket. Temperature and weather resistant. Working temperature -40°C to +200°C.												
External Screws	External screws are in stainless steel with protection grease.												
Cable Entry	Cable entry protected by weather proof grommet. To be used with HO5RN-F/ HO7RN-F cable with 6-13mm. diameter.												
Led	High efficiency LED module utilized chips from world renowned manufacturer. Assembled on MCPCB and mounted on to heat conductive material.												
Driver	High quality constant current LED driver. Conform to safety standard and electromagnetic compatibility standard.												
Internal Wire	Tinned copper conductor with silicone insulated internal wire. IMQ approved. Working temperature -40°C to +180°C.												
Terminal Block	Terminal block in GFR PA6.6 for cable with cross section up to 2.5 sqmm. VDE approved. Class1 luminaire provided with the earth connection.												
Caution	Installation work has to be carried on according to the enclosed installation manual.												
Color	<table border="0"> <tr> <td></td> <td>Black O1</td> </tr> <tr> <td></td> <td>Graphite O2</td> </tr> <tr> <td></td> <td>Dark Grey O3</td> </tr> <tr> <td></td> <td>Aluminum Silver O4</td> </tr> <tr> <td></td> <td>White O6</td> </tr> <tr> <td></td> <td>Wooden Brown O7</td> </tr> </table>		Black O1		Graphite O2		Dark Grey O3		Aluminum Silver O4		White O6		Wooden Brown O7
	Black O1												
	Graphite O2												
	Dark Grey O3												
	Aluminum Silver O4												
	White O6												
	Wooden Brown O7												

### Light Distribution

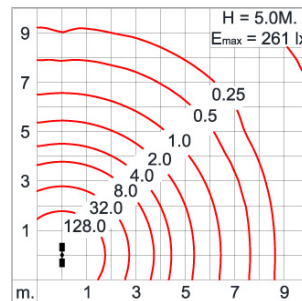
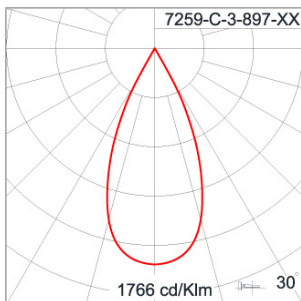

# ATHLON

ATHLON OPTIC – DS

POLE MOUNTED



LAST UPDATE: 13-05-2024

## Bug Report

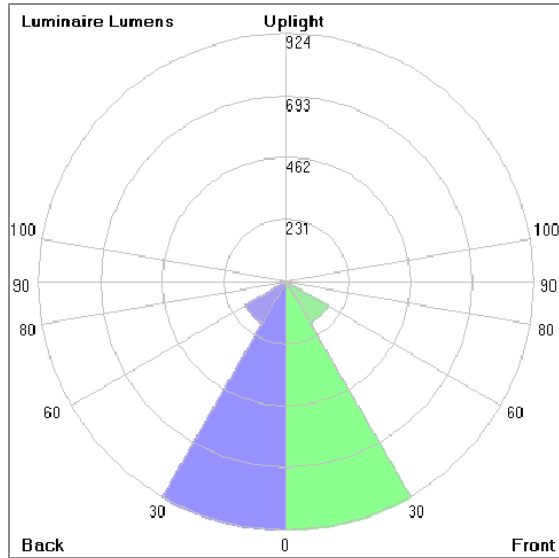

## Lum. Classification System [LCS]

LCS	Zone	%Lumens	%Lamp	%Lum
FL	[0-30]	924.4	32.1	41.0
FM	[30-60]	177.7	6.2	7.9
FH	[60-80]	23.5	0.8	1.0
FVH	[80-90]	1.4	0.0	0.1
BL	[0-30]	924.4	32.1	41.0
BM	[30-60]	177.7	6.2	7.9
BH	[60-80]	23.5	0.8	1.0
BVH	[80-90]	1.4	0.0	0.1
UL	[90-100]	0.3	0.0	0.0
UH	[100-180]	1.0	0.0	0.0
Total		2255.3	78.2	100.0
BUG Rating		B2-U1-G0		

\*Due to the constancy of product development, we reserve the right to alter all specification without prior notice.

# ATHLON

ATHLON OPTIC – DS  
POLE MOUNTED



LAST UPDATE: 13-05-2024

## Accessories



Ordering Code:  
ALUMINUM-POLE-FOR-ATHLON  
Please contact Sales  
Representative



Ordering Code:  
STEEL-POLE-FOR-ATHLON  
Please contact Sales  
Representative



Ordering Code:  
AUN-ACB-0008-00  
Anchor Bolt Kit for  
Galvanized Steel Pole. [for  
Diameter 102mm. and  
151x102mm.]

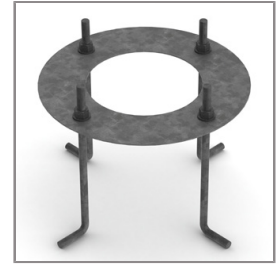

Ordering Code:  
AUN-ACB-0005-00  
Anchor Bolt Kit for  
Aluminium Pole

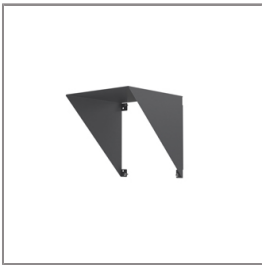

Ordering Code:  
AUN-GHS-0035-XX  
Glare Shield Cap.  
[Pre-assembly from  
factory]

\*Due to the constancy of product development,  
we reserve the right to alter all specification  
without prior notice.

Unilamp Co., Ltd.  
461 Ramintra Road, Kannayao, Bangkok 10230 Thailand  
Tel : +66[0]2 943 2420-1, +66[0]2 946 4170-1  
Fax : +66[0]2 943 2419  
online@unilamp.co.th  
www.unilamp.co.th