

# SIROCCO

## SMALL SIROCCO

### POLE MOUNTED LIGHT



LAST UPDATE: 09-04-2026



SIROCCO is a solid outdoor luminaire for public space illumination. Available in various light distribution, symmetric, asymmetric, bi-symmetric and road optic. Small SIROCCO equipped with a high power LED with high CRI in 3000K or 4000K color temperature with 3 SDCM. Lenses and reflectors for SIROCCO have been engineered utilizing the latest technology and software to maximize the performance. The heat management has been delicately designed and tested under high ambient thermal condition. An integrated scale allows precise aiming of the luminaire to achieve the desired illumination level. SIROCCO is suitable to illuminate medium to large size objects or areas such as signage boards, building facades, parking lots, public parks, pedestrian, small streets and squares. Available as well in HID light source with conventional control gear. Presented with a range of mounting accessories including ground mount base, pole top mount, and wall/pole mounting arm as well as aluminium poles, galvanized steel poles and anchorage unit for concrete foundations.



## Technical Data



Ordering Code :	7241-7-3-907-XX
Lamp :	LED
Beam :	33°/83°
CCT :	4000 K
CRI :	CRI >80
SDCM :	SDCM = 3
Lamp Lumen :	6950 lm
Luminaire Lumen :	5580 lm
Lamp Wattage :	55 W
Luminaire Wattage :	60 W
Efficacy :	93 lm/W
Ambient Temperature :	50°C
Lumen Maintenance	L70B10 >66,000 h
Controller :	On-Off
Input Voltage :	220-240Vac 50/60Hz
Net Weight :	6.70 kg.

### Ordering code guide

XXXX-X-X-XXX-XX  
A B C D E

- A Product Code
- B Reflector
- C Electrical Component
- D Lamp
- E Color

















Icon definition

\*Due to the constancy of product development, we reserve the right to alter all specification without prior notice.

Unilamp Co., Ltd.  
461 Ramintra Road, Kannayao, Bangkok 10230 Thailand  
Tel : +66(O)2 943 2420-1, +66(O)2 946 4170-1  
Fax : +66(O)2 943 2419  
online@unilamp.co.th  
www.unilamp.co.th

### Specification

IEC Standard	IEC 60598-1 General Requirement IEC 60598-2-1 Fixed Luminaires										
Protection	IP65 Class I										
IK Rating	Protection against mechanical impact IK08 on body and IK07 optical part.										
Luminaires Body Housing	High-pressure Die Cast Aluminium alloy body and components. Extruded Aluminium 56063 alloy body with low copper content.										
Coating Process	Nano Ceramic surface conversion, resistant to corrosive environment. Luminaire primarily coated with epoxy resin and top coated with UV stabilized polyester powder and cured in digital temperature controlled chamber at 200°C.										
Diffuser	Impact resistant safety tempered glass cover. Able to withstand the temperature up to 250°C.										
Reflector	High performance CNC forming aluminium reflector sheet.										
Adjustable Optic	Adjustable aiming unit through graduated scale.										
Gasket	Post-cured treated silicone gasket. Temperature and weather resistant. Working temperature -40°C to +200°C.										
External Screws	External screws are in stainless steel with protection grease.										
Cable Entry	Cable entry protected by weather proof grommet. To be used with HO5RN-F/ HO7RN-F cable with 7-10mm. diameter.										
Led	High efficiency LED module utilized chips from world renowned manufacturer. Assembled on MCPCB and mounted on to heat conductive material.										
Driver	High quality constant current LED driver. Conform to safety standard and electromagnetic compatibility standard.										
Enhanced Protection	The luminaire is equipped with a 10kV surge protection device, the function of the protector is indicated by a LED, performance in compliance with IEC61643-11.										
Internal Wire	Tinned copper conductor with silicone insulated internal wire. IMQ approved. Working temperature -40°C to +180°C.										
Terminal Block	Terminal block in GFR PA6.6 for cable with cross section up to 2.5 sqmm. VDE approved. Class1 luminaire provided with the earth connection.										
Caution	Installation work has to be carried on according to the enclosed installation manual.										
Color	<table border="0"> <tr> <td></td> <td>Black O1</td> </tr> <tr> <td></td> <td>Graphite O2</td> </tr> <tr> <td></td> <td>Dark Grey O3</td> </tr> <tr> <td></td> <td>Aluminum Silver O4</td> </tr> <tr> <td></td> <td>White O6</td> </tr> </table>		Black O1		Graphite O2		Dark Grey O3		Aluminum Silver O4		White O6
	Black O1										
	Graphite O2										
	Dark Grey O3										
	Aluminum Silver O4										
	White O6										

### Light Distribution

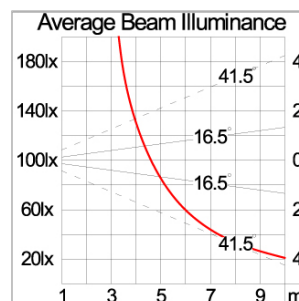
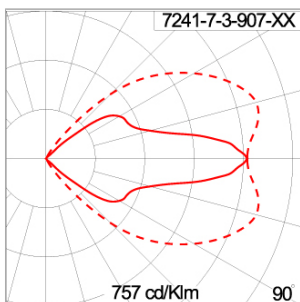

# SIROCCO

## SMALL SIROCCO

### POLE MOUNTED LIGHT



LAST UPDATE: 09-04-2026

#### Accessories



Ordering Code:  
STEEL-POLE-FOR-SMALL-SIROCCO  
Please contact Sales  
Representative



Ordering Code:  
AUN-ACB-0009-00  
Anchor bolt kit, pole  
diameter 114 and 114/140,  
galvanized steel pole



Ordering Code:  
AUN-ACB-0008-00  
Anchor bolt kit, pole  
diameter 102mm and  
151x102mm, galvanized  
steel pole



Ordering Code:  
AUN-ACB-0005-00  
Anchor bolt kit, aluminum  
pole



Ordering Code:  
AUN-MOT-0069-XX  
Double head pole mount  
adapter, 90°, On-Off, for  
76mm spigot diameter



Ordering Code:  
AUN-MOT-0070-XX  
Double head pole mount  
adapter, 180°, On-Off, for  
76mm spigot diameter

\*Due to the constancy of product development,  
we reserve the right to alter all specification  
without prior notice.

Unilamp Co., Ltd.  
461 Ramintra Road, Kannayao, Bangkok 10230 Thailand  
Tel : +66[0]2 943 2420-1, +66[0]2 946 4170-1  
Fax : +66[0]2 943 2419  
online@unilamp.co.th  
www.unilamp.co.th