

# SIROCCO

SMALL SIROCCO OPTIC – AREA LIGHT /  
ASYMMETRIC SINGLE SIDED

POLE MOUNTED



LAST UPDATE: 29-05-2024



SIROCCO is a solid outdoor luminaire for public space illumination. Available in various light distribution, symmetric, asymmetric, bi-symmetric and road optic. Small SIROCCO equipped with a high power LED with high CRI in 3000K or 4000K color temperature with 3 SDCM. Lenses and reflectors for SIROCCO have been engineered utilizing the latest technology and software to maximize the performance. The heat management has been delicately designed and tested under high ambient thermal condition. An integrated scale allows precise aiming of the luminaire to achieve the desired illumination level. SIROCCO is suitable to illuminate medium to large size objects or areas such as signage boards, building facades, parking lots, public parks, pedestrian, small streets and squares. Available as well in HID light source with conventional control gear. Presented with a range of mounting accessories including ground mount base, pole top mount, and wall/pole mounting arm as well as aluminium poles, galvanized steel poles and anchorage unit for concrete foundations.



## Technical Data



|                       |                    |
|-----------------------|--------------------|
| Ordering Code :       | 7240-K-3-674-XX    |
| Lamp :                | LED                |
| Beam :                | Asymmetric         |
| CCT :                 | 3000 K             |
| CRI :                 | CRI >80            |
| SDCM :                | SDCM = 3           |
| Lamp Lumen :          | 6450 lm            |
| Luminaire Lumen :     | 5230 lm            |
| Lamp Wattage :        | 51 W               |
| Luminaire Wattage :   | 57 W               |
| Efficacy :            | 91 lm/W            |
| Ambient Temperature : | 50°C               |
| Lumen Maintenance     | L70B10 >60,000 h   |
| Controller :          | On-Off             |
| Input Voltage :       | 220-240Vac 50/60Hz |
| Net Weight :          | 6.10 kg.           |

### Ordering code guide

XXXX-X-X-XXX-XX

A                      B                      C                      D                      E

- A Product Code
- B Reflector
- C Electrical Component
- D Lamp
- E Color



Icon definition

\*Due to the constancy of product development, we reserve the right to alter all specification without prior notice.

Unilamp Co., Ltd.  
461 Ramintra Road, Kannayao, Bangkok 10230 Thailand  
Tel : +66(O)2 943 2420-1, +66(O)2 946 4170-1  
Fax : +66(O)2 943 2419  
online@unilamp.co.th  
www.unilamp.co.th

# SIROCCO

## SMALL SIROCCO OPTIC – AREA LIGHT / ASYMMETRIC SINGLE SIDED

### POLE MOUNTED



LAST UPDATE: 29-05-2024

### Specification

|                         |   |  |          |  |             |  |              |  |                    |  |          |  |                 |
|-------------------------|---|--|----------|--|-------------|--|--------------|--|--------------------|--|----------|--|-----------------|
| IEC Standard            | IEC 60598-1 General Requirement<br>IEC 60598-2-1 Fixed Luminaires   |  |          |  |             |  |              |  |                    |  |          |  |                 |
| Protection              | IP65 Class I  |  |          |  |             |  |              |  |                    |  |          |  |                 |
| IK Rating               | Protection against mechanical impact IK08 on body and IK07 optical part.  |  |          |  |             |  |              |  |                    |  |          |  |                 |
| Luminaires Body Housing | High-pressure Die Cast Aluminium alloy body and components.<br>Extruded Aluminium 56063 alloy body with low copper content.   |  |          |  |             |  |              |  |                    |  |          |  |                 |
| Coating Process         | Nano Ceramic surface conversion, resistant to corrosive environment. Luminaire primarily coated with epoxy resin and top coated with UV stabilized polyester powder and cured in digital temperature controlled chamber at 200°C.                         |  |          |  |             |  |              |  |                    |  |          |  |                 |
| Diffuser                | Impact resistant safety tempered glass cover. Able to withstand the temperature up to 250°C.  |  |          |  |             |  |              |  |                    |  |          |  |                 |
| Lens                    | Molded PC lens from renowned manufacturers in various light distribution patterns.  |  |          |  |             |  |              |  |                    |  |          |  |                 |
| Adjustable Optic        | Adjustable aiming unit through graduated scale.   |  |          |  |             |  |              |  |                    |  |          |  |                 |
| Gasket                  | Post-cured treated silicone gasket. Temperature and weather resistant. Working temperature -40°C to +200°C.   |  |          |  |             |  |              |  |                    |  |          |  |                 |
| External Screws         | External screws are in stainless steel with protection grease.  |  |          |  |             |  |              |  |                    |  |          |  |                 |
| Cable Entry             | Cable entry protected by weather proof grommet. To be used with HO5RN-F/ HO7RN-F cable with 7-10mm. diameter.   |  |          |  |             |  |              |  |                    |  |          |  |                 |
| Led                     | High efficiency LED module utilized chips from world renowned manufacturer. Assembled on MCPCB and mounted on to heat conductive material.  |  |          |  |             |  |              |  |                    |  |          |  |                 |
| Driver                  | High quality constant current LED driver. Conform to safety standard and electromagnetic compatibility standard.  |  |          |  |             |  |              |  |                    |  |          |  |                 |
| Enhanced Protection     | The luminaire is equipped with a 10kV surge protection device, the function of the protector is indicated by a LED, performance in compliance with IEC61643-11.   |  |          |  |             |  |              |  |                    |  |          |  |                 |
| Internal Wire           | Tinned copper conductor with silicone insulated internal wire. IMQ approved. Working temperature -40°C to +180°C.   |  |          |  |             |  |              |  |                    |  |          |  |                 |
| Terminal Block          | Terminal block in GFR PA6.6 for cable with cross section up to 2.5 sqmm. VDE approved.<br>Class1 luminaire provided with the earth connection.  |  |          |  |             |  |              |  |                    |  |          |  |                 |
| Caution                 | Installation work has to be carried on according to the enclosed installation manual.   |  |          |  |             |  |              |  |                    |  |          |  |                 |
| Color                   | <table><tr><td></td><td>Black O1</td></tr><tr><td></td><td>Graphite O2</td></tr><tr><td></td><td>Dark Grey O3</td></tr><tr><td></td><td>Aluminum Silver O4</td></tr><tr><td></td><td>White O6</td></tr><tr><td></td><td>Wooden Brown O7</td></tr></table> |  | Black O1 |  | Graphite O2 |  | Dark Grey O3 |  | Aluminum Silver O4 |  | White O6 |  | Wooden Brown O7 |
|                         | Black O1  |  |          |  |             |  |              |  |                    |  |          |  |                 |
|                         | Graphite O2   |  |          |  |             |  |              |  |                    |  |          |  |                 |
|                         | Dark Grey O3  |  |          |  |             |  |              |  |                    |  |          |  |                 |
|                         | Aluminum Silver O4  |  |          |  |             |  |              |  |                    |  |          |  |                 |
|                         | White O6  |  |          |  |             |  |              |  |                    |  |          |  |                 |
|                         | Wooden Brown O7   |  |          |  |             |  |              |  |                    |  |          |  |                 |

### Light Distribution

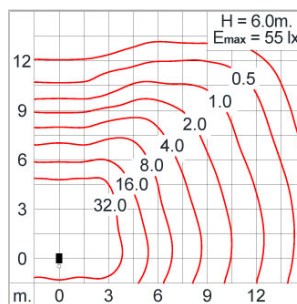
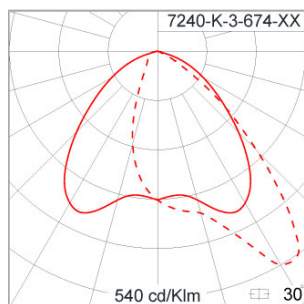

\*Due to the constancy of product development,  
we reserve the right to alter all specification  
without prior notice.

Unilamp Co., Ltd.  
461 Ramintra Road, Kannayao, Bangkok 10230 Thailand  
Tel : +66(0)2 943 2420-1, +66(0)2 946 4170-1  
Fax : +66(0)2 943 2419  
online@unilamp.co.th  
www.unilamp.co.th

# SIROCCO

SMALL SIROCCO OPTIC – AREA LIGHT /  
ASYMMETRIC SINGLE SIDED

POLE MOUNTED



LAST UPDATE: 29-05-2024

## Accessories



Ordering Code:  
STEEL-POLE-FOR-SMALL-SIROCCO  
Please contact Sales  
Representative



Ordering Code:  
AUN-ACB-0009-00  
Anchor bolt kit, pole  
diameter 114 and 114/140,  
galvanized steel pole



Ordering Code:  
AUN-ACB-0008-00  
Anchor bolt kit, pole  
diameter 102mm and  
151x102mm, galvanized  
steel pole

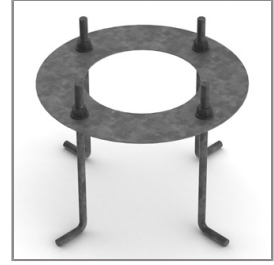

Ordering Code:  
AUN-ACB-0005-00  
Anchor bolt kit, aluminum  
pole

\*Due to the constancy of product development,  
we reserve the right to alter all specification  
without prior notice.

Unilamp Co., Ltd.  
461 Ramintra Road, Kannayao, Bangkok 10230 Thailand  
Tel : +66[0]2 943 2420-1, +66[0]2 946 4170-1  
Fax : +66[0]2 943 2419  
online@unilamp.co.th  
www.unilamp.co.th