

# BLAZE

BLAZE

POLE MOUNTED

 **Unilamp**

LAST UPDATE: 24-02-2025



BLAZE is a family of large size wall mount and pole-top luminaires. The top reflector is easily adjustable from symmetric to asymmetric distribution to get the desired light delivered for most applications and assists with glare control. BLAZE is made for smooth and uniform light distribution on designated areas. The recommended mounting height is between 3 – 5 meters from the ground. It is equipped with high CRI COB LED and is available in 2700K, 3000K and 4000K. Version with traditional HID light source is also available. It is most suited in parking lots, public parks, pedestrian and open spaces. BLAZE is the perfect solution for a glare free installation. Available as an option are Aluminium Poles, Galvanized steel poles and anchorage unit for concrete foundations.

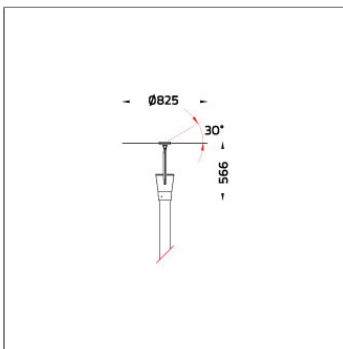

## Technical Data



Ordering Code :	7223-0-5-906-XX
Lamp :	LED
CCT :	4000 K
CRI :	CRI >80
SDCM :	SDCM = 3
Lamp Lumen :	8980 lm
Luminaire Lumen :	5670 lm
Lamp Wattage :	52 W
Luminaire Wattage :	57 W
Efficacy :	99 lm/W
Ambient Temperature :	40°C
Lumen Maintenance	L70B10 >60,000 h
Controller :	DALI
Input Voltage :	220-240Vac 50/60Hz
Net Weight :	11.60 kg.

### Ordering code guide

XXXX-X-X-XXX-XX

A                      B                      C                      D                      E

- A Product Code
- B Reflector
- C Electrical Component
- D Lamp
- E Color



Icon definition

\*Due to the constancy of product development, we reserve the right to alter all specification without prior notice.

Unilamp Co., Ltd.  
461 Ramintra Road, Kannayao, Bangkok 10230 Thailand  
Tel : +66(0)2 943 2420-1, +66(0)2 946 4170-1  
Fax : +66(0)2 943 2419  
online@unilamp.co.th  
www.unilamp.co.th

### Specification

IEC Standard	IEC 60598-1 General Requirement IEC 60598-2-1 Fixed Luminaires
Protection	IP65 Class I
IK Rating	Protection against mechanical impact IK08 on body and IK06 optical part.
Luminaires Body Housing	High-pressure die cast aluminum alloy body and components. Extruded aluminum 56063 alloy body with low copper content.
Coating Process	Nano Ceramic surface conversion, resistant to corrosive environment. Luminaire primarily coated with epoxy resin and top coated with UV stabilized polyester powder and cured in digital temperature controlled chamber at 200°C.
Diffuser	Impact resistant safety tempered glass cover. Able to withstand the temperature up to 250°C. Glass flushes to the front cover, no accumulation of dust and water.
Reflector	Secondary reflector in white coated aluminum.
Adjustable Optic	Adjustable aluminum reflecting plate by tool.
Gasket	Post-cured treated silicone gasket. Temperature and weather resistant. Working temperature -40°C to +200°C.
External Screws	External screws are in stainless steel with protection grease.
Cable Entry	Cable entry protected by M20 cable gland. To be used with H05RN-F/ H07RN-F cable with 7-13mm. diameter.
Led	High efficiency LED module in COB technology. Assembled on MCPCB and mounted on to heat conductive material.
Driver	High quality DALI Driver in constant current. Conform to applicable safety standards and electromagnetic compatibility.
Enhanced Protection	The luminaire is equipped with a 10kV surge protection device, the function of the protector is indicated by a LED, performance in compliance with IEC61643-11
Internal Wire	Tinned copper conductor with silicone insulated internal wire. IMQ approved. Working temperature -40°C to +180°C.
Terminal Block	Terminal block in GFR PA6.6 for cable with cross section up to 2.5 sqmm. VDE approved. Class1 luminaire provided with the earth connection.
Caution	Installation work has to be carried on according to the enclosed installation manual.
Color	 Black O1 Graphite O2 Dark Grey O3 Aluminum Silver O4 White O6

### Light Distribution

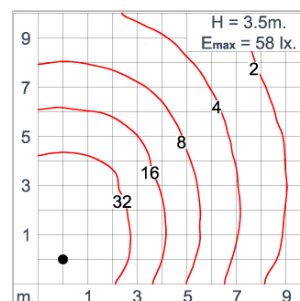
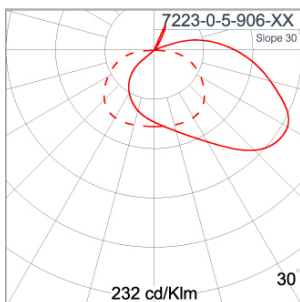

# BLAZE

BLAZE

POLE MOUNTED



LAST UPDATE: 24-02-2025

## Bug Report

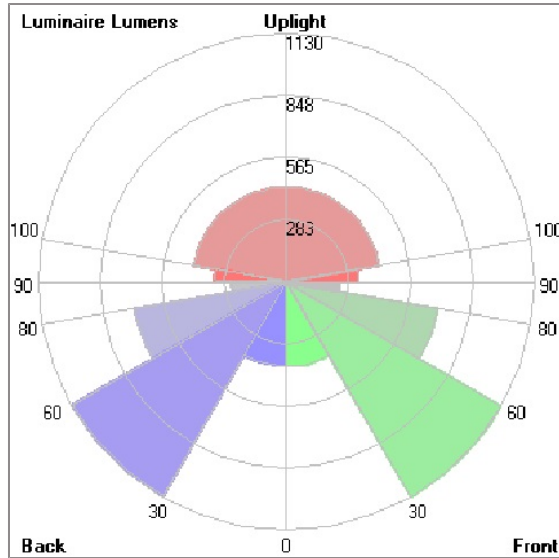

## Lum. Classification System [LCS]

LCS	Zone	%Lumens	%Lamp	%Lum
FL	[0-30]	386.4	4.3	6.8
FM	[30-60]	1130.1	12.6	19.9
FH	[60-80]	700.5	7.8	12.4
FVH	[80-90]	246.3	2.7	4.3
BL	[0-30]	382.4	4.3	6.7
BM	[30-60]	1121.1	12.5	19.8
BH	[60-80]	700.1	7.8	12.3
BVH	[80-90]	246.9	2.7	4.4
UL	[90-100]	327.6	3.6	5.8
UH	[100-180]	428.7	4.8	7.6
Total		5670.1	63.1	100.0
BUG Rating		B2-U3-G3		

\*Due to the constancy of product development, we reserve the right to alter all specification without prior notice.

Unilamp Co., Ltd.  
461 Ramintra Road, Kannayao, Bangkok 10230 Thailand  
Tel : +66[0]2 943 2420-1, +66[0]2 946 4170-1  
Fax : +66[0]2 943 2419  
online@unilamp.co.th  
www.unilamp.co.th

# BLAZE

BLAZE

POLE MOUNTED

 **Unilamp**

LAST UPDATE: 24-02-2025

## Accessories



Ordering Code:  
ALUMINUM-POLE-FOR-BLAZE  
Please contact Sales  
Representative



Ordering Code:  
STEEL-POLE-FOR-BLAZE  
Please contact Sales  
Representative



Ordering Code:  
AUN-ACB-0008-00  
Anchor bolt kit, pole  
diameter 102mm and  
151x102mm, galvanized  
steel pole



Ordering Code:  
AUN-ACB-0005-00  
Anchor bolt kit, aluminum  
pole

\*Due to the constancy of product development,  
we reserve the right to alter all specification  
without prior notice.

Unilamp Co., Ltd.  
461 Ramintra Road, Kannayao, Bangkok 10230 Thailand  
Tel : +66[0]2 943 2420-1, +66[0]2 946 4170-1  
Fax : +66[0]2 943 2419  
online@unilamp.co.th  
www.unilamp.co.th