

# MARANELLO

## MARANELLO

### POLE MOUNTED



LAST UPDATE: 10-03-2025



MARANELLO is a family of large wall mounted area light and pole-top luminaires with symmetrical low glare indirect light distribution. It is available with COB LED in two wattages in 2700K, 3000K or 4000K as well as a HID light source with traditional control gear. MARANELLO blends well with all contemporary architectural design during the day and night. It has proven its success in both design and quality. The recommended mounting height is between 3 – 5 meters. Available as an option are Aluminium Poles, Galvanized steel poles and anchorage unit for concrete foundations.

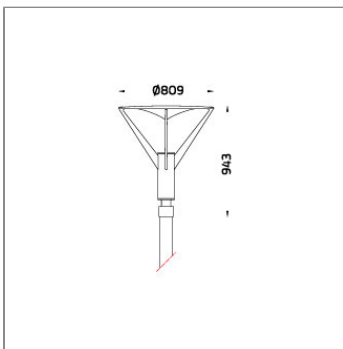

### Technical Data



Ordering Code :	7222-0-4-903-XX
Lamp :	LED
CCT :	3000 K
CRI :	CRI >80
SDCM :	SDCM = 3
Lamp Lumen :	11170 lm
Luminaire Lumen :	3330 lm
Lamp Wattage :	70 W
Luminaire Wattage :	75 W
Efficacy :	44 lm/W
Ambient Temperature :	35°C
Lumen Maintenance	L70B10 >60,000 h
Controller :	DIM 1-10V
Input Voltage :	220-240Vac 50/60Hz
Net Weight :	14.80 kg.

#### Ordering code guide

XXXX-X-X-XXX-XX

A B C D E

- A Product Code
- B Reflector
- C Electrical Component
- D Lamp
- E Color



Icon definition

\*Due to the constancy of product development, we reserve the right to alter all specification without prior notice.















Unilamp Co., Ltd.  
461 Ramintra Road, Kannayao, Bangkok 10230 Thailand  
Tel : +66(0)2 943 2420-1, +66(0)2 946 4170-1  
Fax : +66(0)2 943 2419  
online@unilamp.co.th  
www.unilamp.co.th

## MARANELLO

### POLE MOUNTED

LAST UPDATE: 10-03-2025

### Specification

IEC Standard	IEC 60598-1 General Requirement IEC 60598-2-1 Fixed Luminaires										
Protection	IP65 Class I										
IK Rating	Protection against mechanical impact IK08 on body and IK07 optical part.										
Luminaires Body Housing	High-pressure die cast aluminum alloy body and components. Extruded aluminum S6063 alloy body with low copper content.										
Coating Process	Nano Ceramic surface conversion, resistant to corrosive environment. Luminaire primarily coated with epoxy resin and top coated with UV stabilized polyester powder and cured in digital temperature controlled chamber at 200°C.										
Diffuser	Impact resistant safety tempered glass cover. Able to withstand the temperature up to 250°C. Glass flushes to the front cover, no accumulation of dust and water.										
Reflector	Secondary reflector in white coated aluminum.										
Gasket	Post-cured treated silicone gasket. Temperature and weather resistant. Working temperature -40°C to +200°C.										
External Screws	External screws are in stainless steel with protection grease.										
Led	High efficiency LED module in COB technology. Assembled on MCPCB and mounted on to heat conductive material.										
Driver	High quality Dimmable Driver (1-10V) in constant current. Conform to applicable safety standards and electromagnetic compatibility.										
Enhanced Protection	The luminaire is equipped with a 10kV surge protection device, the function of the protector is indicated by a LED, performance in compliance with IEC61643-11.										
Internal Wire	Tinned copper conductor with silicone insulated internal wire. IMQ approved. Working temperature -40°C to +180°C.										
Terminal Block	Terminal block in GFR PA6.6 for cable with cross section up to 2.5 sqmm. VDE approved. Class1 luminaire provided with the earth connection.										
Caution	Installation work has to be carried on according to the enclosed installation manual.										
Color	<table border="0"> <tr> <td></td> <td>Black O1</td> </tr> <tr> <td></td> <td>Graphite O2</td> </tr> <tr> <td></td> <td>Dark Grey O3</td> </tr> <tr> <td></td> <td>Aluminum Silver O4</td> </tr> <tr> <td></td> <td>White O6</td> </tr> </table>		Black O1		Graphite O2		Dark Grey O3		Aluminum Silver O4		White O6
	Black O1										
	Graphite O2										
	Dark Grey O3										
	Aluminum Silver O4										
	White O6										

### Light Distribution

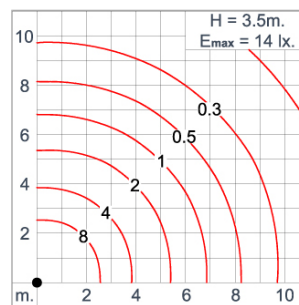
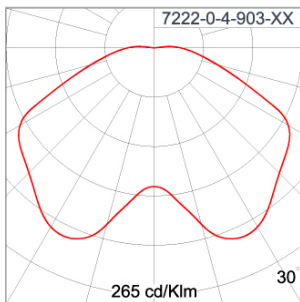

# MARANELLO

MARANELLO

POLE MOUNTED



LAST UPDATE: 10-03-2025

## Bug Report

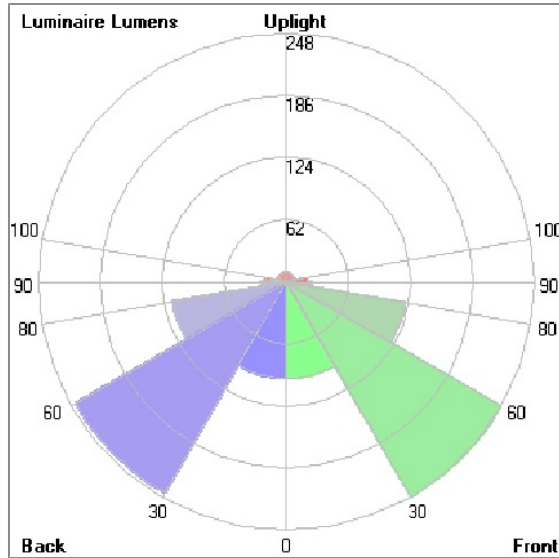

## Lum. Classification System [LCS]

LCS	Zone	%Lumens	%Lamp	%Lum
FL	[0-30]	96.8	9.7	9.7
FM	[30-60]	248.1	24.8	24.8
FH	[60-80]	120.6	12.1	12.1
FVH	[80-90]	25.7	2.6	2.6
BL	[0-30]	96.1	9.6	9.6
BM	[30-60]	243.3	24.3	24.3
BH	[60-80]	115.0	11.5	11.5
BVH	[80-90]	24.5	2.5	2.5
UL	[90-100]	21.2	2.1	2.1
UH	[100-180]	8.5	0.9	0.9
Total		999.8	100.1	100.0
BUG Rating		B1-U2-G1		

\*Due to the constancy of product development, we reserve the right to alter all specification without prior notice.

Unilamp Co., Ltd.  
461 Ramintra Road, Kannayao, Bangkok 10230 Thailand  
Tel : +66[0]2 943 2420-1, +66[0]2 946 4170-1  
Fax : +66[0]2 943 2419  
online@unilamp.co.th  
www.unilamp.co.th

# MARANELLO

MARANELLO

POLE MOUNTED

 **Unilamp**

LAST UPDATE: 10-03-2025

## Accessories



Ordering Code:  
ALUMINUM-POLE-FOR-MARANELLO  
Please contact Sales  
Representative



Ordering Code:  
STEEL-POLE-FOR-MARANELLO  
Please contact Sales  
Representative



Ordering Code:  
AUN-ACB-0008-00  
Anchor bolt kit, pole  
diameter 102mm and  
151x102mm, galvanized  
steel pole



Ordering Code:  
AUN-ACB-0005-00  
Anchor bolt kit, aluminum  
pole

\*Due to the constancy of product development,  
we reserve the right to alter all specification  
without prior notice.

Unilamp Co., Ltd.  
461 Ramintra Road, Kannayao, Bangkok 10230 Thailand  
Tel : +66[0]2 943 2420-1, +66[0]2 946 4170-1  
Fax : +66[0]2 943 2419  
online@unilamp.co.th  
www.unilamp.co.th