

MARANELLO

MARANELLO

POLE MOUNTED



LAST UPDATE: 18-06-2024



MARANELLO is a family of large wall mounted area light and pole-top luminaires with symmetrical low glare indirect light distribution. It is available with COB LED in two wattages in 2700K, 3000K or 4000K as well as a HID light source with traditional control gear. MARANELLO blends well with all contemporary architectural design during the day and night. It has proven its success in both design and quality. The recommended mounting height is between 3 – 5 meters. Available as an option are Aluminium Poles, Galvanized steel poles and anchorage unit for concrete foundations.

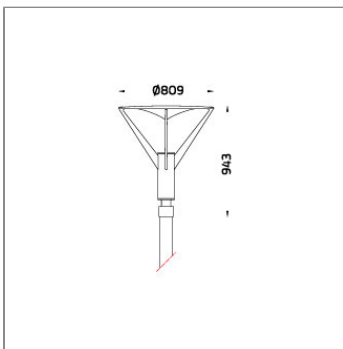

Technical Data



| | |
|-----------------------|--------------------|
| Ordering Code : | 7222-0-3-892-XX |
| Lamp : | LED |
| CCT : | 4000 K |
| CRI : | CRI >80 |
| SDCM : | SDCM = 3 |
| Lamp Lumen : | 8980 lm |
| Luminaire Lumen : | 2680 lm |
| Lamp Wattage : | 52 W |
| Luminaire Wattage : | 57 W |
| Efficacy : | 47 lm/W |
| Ambient Temperature : | 50°C |
| Lumen Maintenance | L70B10 >60,000 h |
| Controller : | On-Off |
| Input Voltage : | 220-240Vac 50/60Hz |
| Net Weight : | 14.90 kg. |

Ordering code guide

XXXX-X-X-XXX-XX

A B C D E

- A Product Code
- B Reflector
- C Electrical Component
- D Lamp
- E Color



Icon definition

*Due to the constancy of product development, we reserve the right to alter all specification without prior notice.



















Unilamp Co., Ltd.
461 Ramintra Road, Kannayao, Bangkok 10230 Thailand
Tel : +66(0)2 943 2420-1, +66(0)2 946 4170-1
Fax : +66(0)2 943 2419
online@unilamp.co.th
www.unilamp.co.th

MARANELLO

POLE MOUNTED

LAST UPDATE: 18-06-2024

Specification

| | | | | | | | | | | | | | |
|---|---|---|----------|---|-------------|---|--------------|---|--------------------|---|----------|---|-----------------|
| IEC Standard | IEC 60598-1 General Requirement IEC 60598-2-1 Fixed Luminaires | | | | | | | | | | | | |
| Protection | IP65 Class I | | | | | | | | | | | | |
| IK Rating | Protection against mechanical impact IK08 on body and IK07 optical part. | | | | | | | | | | | | |
| Luminaires Body Housing | High-pressure die cast aluminum alloy body and components. Extruded aluminum 56063 alloy body with low copper content. | | | | | | | | | | | | |
| Coating Process | Nano Ceramic surface conversion, resistant to corrosive environment. Luminaire primarily coated with epoxy resin and top coated with UV stabilized polyester powder and cured in digital temperature controlled chamber at 200°C. | | | | | | | | | | | | |
| Diffuser | Impact resistant safety tempered glass cover. Able to withstand the temperature up to 250°C. Glass flushes to the front cover, no accumulation of dust and water. | | | | | | | | | | | | |
| Reflector | Secondary reflector in white coated aluminum. | | | | | | | | | | | | |
| Gasket | Post-cured treated silicone gasket. Temperature and weather resistant. Working temperature -40°C to +200°C. | | | | | | | | | | | | |
| External Screws | External screws are in stainless steel with protection grease. | | | | | | | | | | | | |
| Led | High efficiency LED module in COB technology. Assembled on MCPCB and mounted on to heat conductive material. | | | | | | | | | | | | |
| Driver | High quality constant current LED driver. Conform to safety standard and electromagnetic compatibility standard. | | | | | | | | | | | | |
| Enhanced Protection | The luminaire is equipped with a 10kV surge protection device, the function of the protector is indicated by a LED, performance in compliance with IEC61643-11. | | | | | | | | | | | | |
| Internal Wire | Tinned copper conductor with silicone insulated internal wire. IMQ approved. Working temperature -40°C to +180°C. | | | | | | | | | | | | |
| Terminal Block | Terminal block in GFR PA6.6 for cable with cross section up to 2.5 sqmm. VDE approved. Class1 luminaire provided with the earth connection. | | | | | | | | | | | | |
| Caution | Installation work has to be carried on according to the enclosed installation manual. | | | | | | | | | | | | |
| Color | <table border="0"> <tr><td></td><td>Black O1</td></tr> <tr><td></td><td>Graphite O2</td></tr> <tr><td></td><td>Dark Grey O3</td></tr> <tr><td></td><td>Aluminum Silver O4</td></tr> <tr><td></td><td>White O6</td></tr> <tr><td></td><td>Wooden Brown O7</td></tr> </table> |  | Black O1 |  | Graphite O2 |  | Dark Grey O3 |  | Aluminum Silver O4 |  | White O6 |  | Wooden Brown O7 |
|  | Black O1 | | | | | | | | | | | | |
|  | Graphite O2 | | | | | | | | | | | | |
|  | Dark Grey O3 | | | | | | | | | | | | |
|  | Aluminum Silver O4 | | | | | | | | | | | | |
|  | White O6 | | | | | | | | | | | | |
|  | Wooden Brown O7 | | | | | | | | | | | | |

Light Distribution

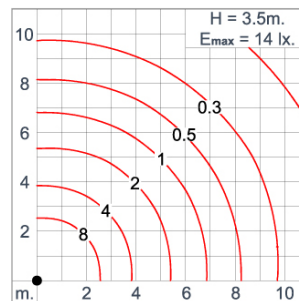
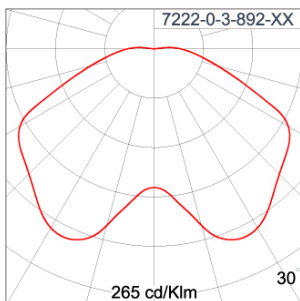

MARANELLO

MARANELLO

POLE MOUNTED



LAST UPDATE: 18-06-2024

Bug Report

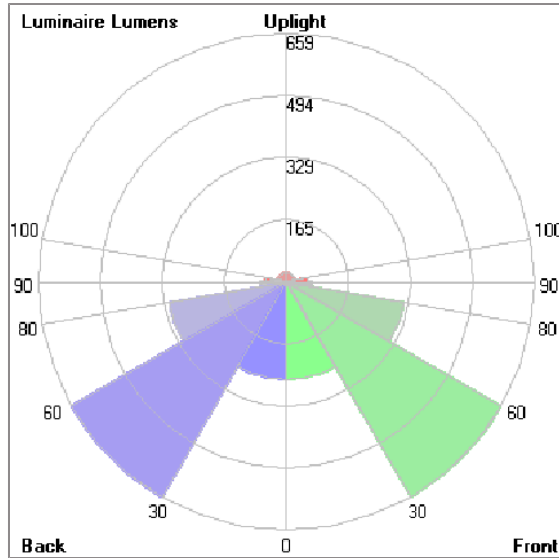

Lum. Classification System [LCS]

| LCS | Zone | %Lumens | %Lamp | %Lum |
|------------|-----------|----------|-------|-------|
| FL | [0-30] | 258.5 | 2.9 | 9.6 |
| FM | [30-60] | 658.6 | 7.3 | 24.6 |
| FH | [60-80] | 315.7 | 3.5 | 11.8 |
| FVH | [80-90] | 67.3 | 0.7 | 2.5 |
| BL | [0-30] | 258.5 | 2.9 | 9.6 |
| BM | [30-60] | 658.6 | 7.3 | 24.6 |
| BH | [60-80] | 315.7 | 3.5 | 11.8 |
| BVH | [80-90] | 67.3 | 0.7 | 2.5 |
| UL | [90-100] | 56.7 | 0.6 | 2.1 |
| UH | [100-180] | 23.0 | 0.3 | 0.9 |
| Total | | 2679.9 | 29.7 | 100.0 |
| BUG Rating | | B1-U3-G1 | | |

*Due to the constancy of product development, we reserve the right to alter all specification without prior notice.

Unilamp Co., Ltd.
461 Ramintra Road, Kannayao, Bangkok 10230 Thailand
Tel : +66[0]2 943 2420-1, +66[0]2 946 4170-1
Fax : +66[0]2 943 2419
online@unilamp.co.th
www.unilamp.co.th

MARANELLO

MARANELLO

POLE MOUNTED



LAST UPDATE: 18-06-2024

Accessories



Ordering Code:
ALUMINUM-POLE-FOR-MARANELLO
Please contact Sales
Representative



Ordering Code:
STEEL-POLE-FOR-MARANELLO
Please contact Sales
Representative



Ordering Code:
AUN-ACB-0008-00
Anchor bolt kit, pole
diameter 102mm and
151x102mm, galvanized
steel pole



Ordering Code:
AUN-ACB-0005-00
Anchor bolt kit, aluminum
pole

*Due to the constancy of product development,
we reserve the right to alter all specification
without prior notice.

Unilamp Co., Ltd.
461 Ramintra Road, Kannayao, Bangkok 10230 Thailand
Tel : +66[0]2 943 2420-1, +66[0]2 946 4170-1
Fax : +66[0]2 943 2419
online@unilamp.co.th
www.unilamp.co.th