

BUZZ

BUZZ4

ON-GROUND

 **Unilamp**

LAST UPDATE: 24-02-2025



BUZZ is a robust ground mounted luminaire with excellent light control with three different types of light distribution. BUZZ has a wide beam light throw from a low mounting height which makes it a perfect fixture for illuminating the ground surface. It provides brilliant lighting quality with no glare from the above viewing angle. It is available in two sizes and operated with COB LED or HID light source. With the strong LM6 aluminium construction and clear polycarbonate cover, it protects the luminaire from dust and water and possible harmful impact. BUZZ is generally installed in the walkways and pathways in both private and public areas to provide visual guidance in the architectural environment. Anchorage unit for concrete foundation is available as an accessory.

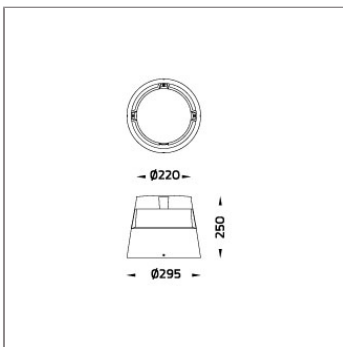

Technical Data



| | |
|-----------------------|--------------------|
| Ordering Code : | 7166-0-3-506-XX |
| Lamp : | LED |
| CCT : | 2700 K |
| CRI : | CRI >80 |
| SDCM : | SDCM = 3 |
| Lamp Lumen : | 3160 lm |
| Luminaire Lumen : | 1130 lm |
| Lamp Wattage : | 23 W |
| Luminaire Wattage : | 27.0 W |
| Efficacy : | 41 lm/W |
| Ambient Temperature : | 50°C |
| Lumen Maintenance | L70B10 >90,000 h |
| Controller : | On-Off |
| Input Voltage : | 220-240Vac 50/60Hz |
| Net Weight : | - kg. |

Ordering code guide

XXXX-X-X-XXX-XX
A B C D E

- A Product Code
- B Reflector
- C Electrical Component
- D Lamp
- E Color

















Icon definition

*Due to the constancy of product development, we reserve the right to alter all specification without prior notice.

Unilamp Co., Ltd.
461 Ramintra Road, Kannayao, Bangkok 10230 Thailand
Tel : +66(O)2 943 2420-1, +66(O)2 946 4170-1
Fax : +66(O)2 943 2419
online@unilamp.co.th
www.unilamp.co.th

Specification

| | | | | | | | | | | | |
|---|--|---|----------|---|-------------|---|--------------|---|--------------------|---|----------|
| IEC Standard | IEC 60598-1 General Requirement IEC 60598-2-1 Fixed Luminaires | | | | | | | | | | |
| Protection | IP66 Class I | | | | | | | | | | |
| IK Rating | Protection against mechanical impact IK08 on body and IK10 optical part. | | | | | | | | | | |
| Luminaires Body Housing | High-pressure die cast aluminum alloy body and components. | | | | | | | | | | |
| Coating Process | Nano Ceramic surface conversion, resistant to corrosive environment. Luminaire primarily coated with epoxy resin and top coated with UV stabilized polyester powder and cured in digital temperature controlled chamber at 200°C. | | | | | | | | | | |
| Diffuser | Self-extinguishing high impact resistant clear polycarbonate diffuser with UV stabilized additive. | | | | | | | | | | |
| Reflector | High performance anodized spun aluminum reflector. | | | | | | | | | | |
| Gasket | Post-cured treated silicone gasket. Temperature and weather resistant. Working temperature -40°C to +200°C. | | | | | | | | | | |
| External Screws | External screws are in stainless steel with protection grease. | | | | | | | | | | |
| Cable Entry | Cable entry protected by M20 cable gland. To be used with H05RN-F/ H07RN-F cable with 7-13mm. diameter. | | | | | | | | | | |
| Led | High efficiency LED module in COB technology. Assembled on MCPCB and mounted on to heat conductive material. | | | | | | | | | | |
| Driver | High quality constant current LED driver. Conform to safety standard and electromagnetic compatibility standard. | | | | | | | | | | |
| Enhanced Protection | The luminaire is equipped with a 10kV surge protection device, the function of the protector is indicated by a LED, performance in compliance with IEC61643-11. | | | | | | | | | | |
| Internal Wire | Tinned copper conductor with silicone insulated internal wire. IMQ approved. Working temperature -40°C to +180°C. | | | | | | | | | | |
| Terminal Block | Terminal block in GFR PA6.6 for cable with cross section up to 2.5 sqmm. VDE approved. Class1 luminaire provided with the earth connection. | | | | | | | | | | |
| Pre-Wire Cable | Pre-wired with 3x1.0 sqmm. H07RN-F neoprene cable. IMQ approved. | | | | | | | | | | |
| Caution | Installation work has to be carried on according to the enclosed installation manual. | | | | | | | | | | |
| Color | <table border="0"> <tr> <td></td> <td>Black O1</td> </tr> <tr> <td></td> <td>Graphite O2</td> </tr> <tr> <td></td> <td>Dark Grey O3</td> </tr> <tr> <td></td> <td>Aluminum Silver O4</td> </tr> <tr> <td></td> <td>White O6</td> </tr> </table> |  | Black O1 |  | Graphite O2 |  | Dark Grey O3 |  | Aluminum Silver O4 |  | White O6 |
|  | Black O1 | | | | | | | | | | |
|  | Graphite O2 | | | | | | | | | | |
|  | Dark Grey O3 | | | | | | | | | | |
|  | Aluminum Silver O4 | | | | | | | | | | |
|  | White O6 | | | | | | | | | | |

Light Distribution

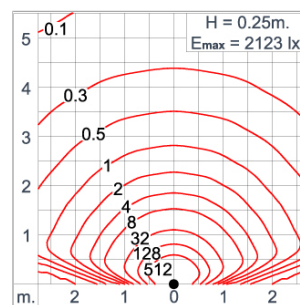
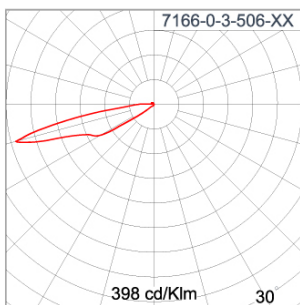

BUZZ

BUZZ4

ON-GROUND

The Unilamp logo consists of a white bell icon inside a square, followed by the word "Unilamp" in a bold, white, sans-serif font, all set against a red background.

LAST UPDATE: 24-02-2025

Accessories



Ordering Code:
AUN-ACB-0004-00
Anchor bolt kit

*Due to the constancy of product development,
we reserve the right to alter all specification
without prior notice.

Unilamp Co., Ltd.
461 Ramintra Road, Kannayao, Bangkok 10230 Thailand
Tel : +66[0]2 943 2420-1, +66[0]2 946 4170-1
Fax : +66[0]2 943 2419
online@unilamp.co.th
www.unilamp.co.th