

AGAR

AGAR BOLLARD

BOLLARD



LAST UPDATE: 20-05-2024



AGAR a range of wall light and bollard with COB LED which are generally installed in the walk ways, parks and open spaces. The vandal resistant polycarbonate diffuser is available in prismatic or opal option. AGAR spreads the light evenly on walls and surfaces and at the same time provides glare free comfortable light distribution for the architectural environment as well as being an eye-catching object. Three color temperatures with a high CRI makes AGAR suitable for professional lighting application. The bollard height can be customized according to specific requirement. Version with HID lamps and E27 holder for Led retrofit lamps are also available on request. An anchorage unit is available as an accessory.

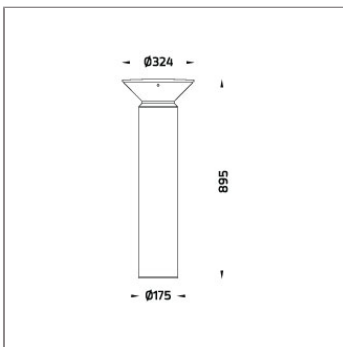

Technical Data



Ordering Code :	7123-0-3-874-XX
Lamp :	LED
CCT :	4000 K
CRI :	CRI >80
SDCM :	SDCM = 3
Lamp Lumen :	1900 lm
Luminaire Lumen :	840 lm
Lamp Wattage :	20 W
Luminaire Wattage :	20 W
Efficacy :	42 lm/W
Ambient Temperature :	40°C
Lumen Maintenance	L70B50 >40,000 h
Controller :	On-Off [AC LED]
Input Voltage :	220-240Vac 50/60Hz
Net Weight :	7.12 kg.

Ordering code guide

XXXX-X-X-XXX-XX

A B C D E

- A Product Code
- B Reflector
- C Electrical Component
- D Lamp
- E Color





















Icon definition

*Due to the constancy of product development, we reserve the right to alter all specification without prior notice.

Unilamp Co., Ltd.
461 Ramintra Road, Kannayao, Bangkok 10230 Thailand
Tel : +66[0]2 943 2420-1, +66[0]2 946 4170-1
Fax : +66[0]2 943 2419
online@unilamp.co.th
www.unilamp.co.th

Specification

IEC Standard	IEC 60598-1 General Requirement IEC 60598-2-1 Fixed Luminaires												
Protection	IP65 Class I												
IK Rating	Protection against mechanical impact IK08 on body and optical part.												
Luminaires Body Housing	High-pressure die cast aluminum alloy body and components. Extruded aluminum 56063 alloy body with low copper content.												
Coating Process	Nano Ceramic surface conversion, resistant to corrosive environment. Luminaire primarily coated with epoxy resin and top coated with UV stabilized polyester powder and cured in digital temperature controlled chamber at 200°C.												
Diffuser	Self-extinguishing high impact resistant prismatic polycarbonate diffuser with UV stabilized additive.												
Gasket	Post-cured treated silicone gasket. Temperature and weather resistant. Working temperature -40°C to +200°C.												
External Screws	External screws are in stainless steel with protection grease.												
Cable Entry	Cable entry protected by weather proof grommet. To be used with HO5RN-F/ HO7RN-F cable with 6-13mm. diameter.												
Led	High quality AC LED module. Conform to safety standard and electromagnetic compatibility standard.												
Internal Wire	Tinned copper conductor with silicone insulated internal wire. IMQ approved. Working temperature -40°C to +180°C.												
Terminal Block	Terminal block in GFR PA6.6 for cable with cross section up to 2.5 sqmm. VDE approved. Class1 luminaire provided with the earth connection.												
Pre-Wire Cable	Pre-wired with 3x0.75 sqmm. HO5RN-F neoprene cable. IMQ approved. Equipped with anti-humidity kit.												
Caution	Installation work has to be carried on according to the enclosed installation manual.												
Color	<table border="0"> <tr><td></td><td>Black O1</td></tr> <tr><td></td><td>Graphite O2</td></tr> <tr><td></td><td>Dark Grey O3</td></tr> <tr><td></td><td>Aluminum Silver O4</td></tr> <tr><td></td><td>White O6</td></tr> <tr><td></td><td>Wooden Brown O7</td></tr> </table>		Black O1		Graphite O2		Dark Grey O3		Aluminum Silver O4		White O6		Wooden Brown O7
	Black O1												
	Graphite O2												
	Dark Grey O3												
	Aluminum Silver O4												
	White O6												
	Wooden Brown O7												

Light Distribution

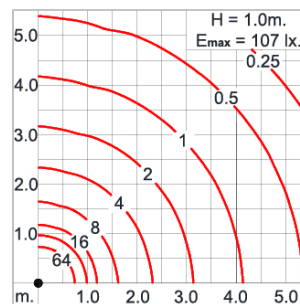
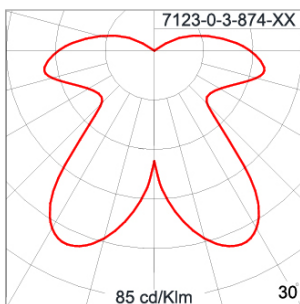

AGAR

AGAR BOLLARD

BOLLARD



LAST UPDATE: 20-05-2024

Bug Report

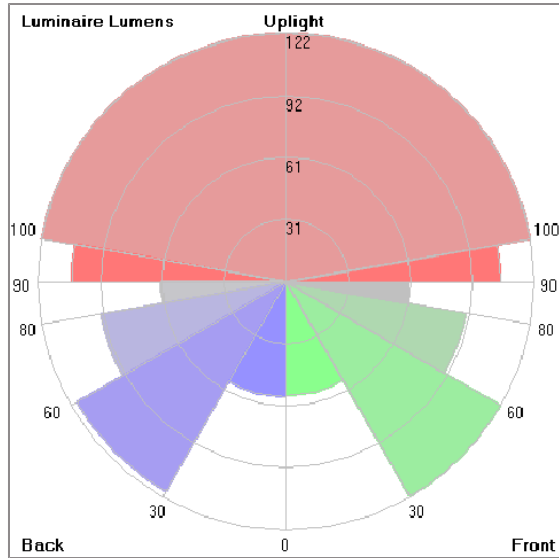

Lum. Classification System [LCS]

LCS	Zone	%Lumens	%Lamp	%Lum
FL	[0-30]	55.9	2.9	6.3
FM	[30-60]	121.6	6.4	13.7
FH	[60-80]	89.8	4.7	10.2
FVH	[80-90]	60.0	3.2	6.8
BL	[0-30]	56.5	3.0	6.4
BM	[30-60]	118.7	6.2	13.4
BH	[60-80]	92.8	4.9	10.5
BVH	[80-90]	61.5	3.2	7.0
UL	[90-100]	105.4	5.5	11.9
UH	[100-180]	122.1	6.4	13.8
Total		884.3	46.4	100.0
BUG Rating				BO-U3-G1

*Due to the constancy of product development,
we reserve the right to alter all specification
without prior notice.

Unilamp Co., Ltd.
461 Ramintra Road, Kannayao, Bangkok 10230 Thailand
Tel : +66[0]2 943 2420-1, +66[0]2 946 4170-1
Fax : +66[0]2 943 2419
online@unilamp.co.th
www.unilamp.co.th

Accessories



Ordering Code:
AUN-CON-0009-00
IP68 connection device,
cable diameter 5-9.5mm,
On-Off



Ordering Code:
AUN-CON-0010-00
IP68 connection device 3
pole, cable diameter
5-9.5mm, with distribution
block



Ordering Code:
AUN-CON-0013-00
IP68 connection device,
cable diameter 7-11.5mm,
On-Off



Ordering Code:
AUN-ACB-0001-00
Anchor bolt kit, bollard