

# AGAR

## AGAR BOLLARD

### BOLLARD



LAST UPDATE: 10-05-2024



AGAR a range of wall light and bollard with COB LED which are generally installed in the walk ways, parks and open spaces. The vandal resistant polycarbonate diffuser is available in prismatic or opal option. AGAR spreads the light evenly on walls and surfaces and at the same time provides glare free comfortable light distribution for the architectural environment as well as being an eye-catching object. Three color temperatures with a high CRI makes AGAR suitable for professional lighting application. The bollard height can be customized according to specific requirement. Version with HID lamps and E27 holder for Led retrofit lamps are also available on request. An anchorage unit is available as an accessory.

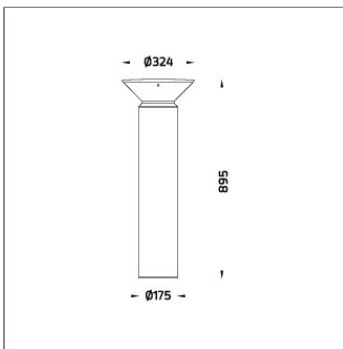

## Technical Data



Ordering Code :	7123-0-3-436-XX
Lamp :	TC-TEL
Socket :	GX24q-4
CCT :	2700-4000 K
Lamp Lumen :	3200 lm
Luminaire Lumen :	3200 lm
Lamp Wattage :	42 W
Luminaire Wattage :	42 W
Ambient Temperature :	25°C
Controller :	On-Off
Energy Class :	A++
Input Voltage :	220-240Vac 50/60Hz
Net Weight :	7.44 kg.

### Ordering code guide

XXXX-X-X-XXX-XX

A B C D E

- A Product Code
- B Reflector
- C Electrical Component
- D Lamp
- E Color





















Icon definition

\*Due to the constancy of product development, we reserve the right to alter all specification without prior notice.

Unilamp Co., Ltd.  
461 Ramintra Road, Kannayao, Bangkok 10230 Thailand  
Tel : +66(0)2 943 2420-1, +66(0)2 946 4170-1  
Fax : +66(0)2 943 2419  
online@unilamp.co.th  
www.unilamp.co.th

### Specification

IEC Standard	IEC 60598-1 General Requirement IEC 60598-2-1 Fixed Luminaires												
Protection	IP54 Class I												
IK Rating	Protection against mechanical impact IK08 on body and optical part.												
Luminaires Body Housing	High-pressure die cast aluminum alloy body and components. Extruded aluminum 56063 alloy body with low copper content.												
Coating Process	Nano Ceramic surface conversion, resistant to corrosive environment. Luminaire primarily coated with epoxy resin and top coated with UV stabilized polyester powder and cured in digital temperature controlled chamber at 200°C.												
Diffuser	Self-extinguishing high impact resistant prismatic polycarbonate diffuser with UV stabilized additive.												
Gasket	Post-cured treated silicone gasket. Temperature and weather resistant. Working temperature -40°C to +200°C.												
External Screws	External screws are in stainless steel with protection grease.												
Cable Entry	Cable entry protected by weather proof grommet. To be used with HO5RN-F/ HO7RN-F cable with 6-13mm. diameter.												
Lamp Holder	G24q/ GX24q lampholder in PBT body. IMQ/ ENEC approved.												
Ballast	Electronic ballast for fluorescent lamp. ENEC approved.												
Internal Wire	Tinned copper conductor with silicone insulated internal wire. IMQ approved. Working temperature -40°C to +180°C.												
Terminal Block	Terminal block in GFR PA6.6 for cable with cross section up to 2.5 sqmm. VDE approved. Class1 luminaire provided with the earth connection.												
Caution	Installation work has to be carried on according to the enclosed installation manual.												
Color	<table border="0"> <tr><td></td><td>Black O1</td></tr> <tr><td></td><td>Graphite O2</td></tr> <tr><td></td><td>Dark Grey O3</td></tr> <tr><td></td><td>Aluminum Silver O4</td></tr> <tr><td></td><td>White O6</td></tr> <tr><td></td><td>Wooden Brown O7</td></tr> </table>		Black O1		Graphite O2		Dark Grey O3		Aluminum Silver O4		White O6		Wooden Brown O7
	Black O1												
	Graphite O2												
	Dark Grey O3												
	Aluminum Silver O4												
	White O6												
	Wooden Brown O7												

### Light Distribution

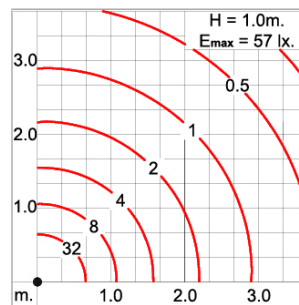
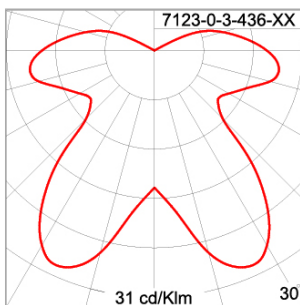

# AGAR

## AGAR BOLLARD

### BOLLARD



LAST UPDATE: 10-05-2024

#### Bug Report

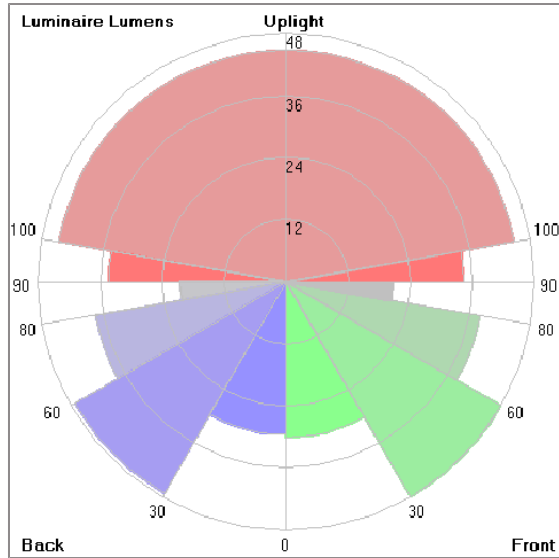

#### Lum. Classification System [LCS]

LCS	Zone	%Lumens	%Lamp	%Lum
FL	[0-30]	29.9	0.9	8.6
FM	[30-60]	47.7	1.5	13.7
FH	[60-80]	37.8	1.2	10.9
FVH	[80-90]	20.5	0.6	5.9
BL	[0-30]	29.4	0.9	8.4
BM	[30-60]	46.8	1.5	13.5
BH	[60-80]	37.2	1.2	10.7
BVH	[80-90]	20.4	0.6	5.9
UL	[90-100]	34.0	1.1	9.8
UH	[100-180]	44.4	1.4	12.7
Total		348.1	10.9	100.0
BUG Rating				BO-U2-G1

\*Due to the constancy of product development, we reserve the right to alter all specification without prior notice.

Unilamp Co., Ltd.  
461 Ramintra Road, Kannayao, Bangkok 10230 Thailand  
Tel : +66[0]2 943 2420-1, +66[0]2 946 4170-1  
Fax : +66[0]2 943 2419  
online@unilamp.co.th  
www.unilamp.co.th

### Accessories



Ordering Code:  
AUN-CON-0009-00  
IP68 Water Tight  
Connecting Device, 3 Pole,  
Cable Diameter 5.0 –  
9.5mm.



Ordering Code:  
AUN-CON-0010-00  
IP68 Water Tight  
Connecting Device with  
Distribution block, 3 pole, 1  
input, 2 outputs, Cable  
Diameter 5.0 – 9.5mm.



Ordering Code:  
AUN-CON-0013-00  
IP68 Water Tight  
Connecting Device, 3 Pole,  
Cable Diameter 7 – 11.5mm.



Ordering Code:  
AUN-ACB-0001-00  
Anchor Bolt Kit for Bollard