

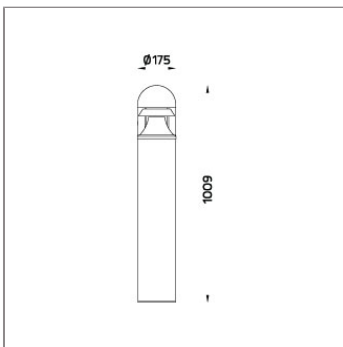

FUJI is a family of shielded bollard with symmetrical light distribution. FUJI is fitted with the latest generation of COB LED with exceptional color consistency. The family is also available in HID version and with E27 holder for Led retrofit lamps. It is generally installed in walkways, parks, commercial areas and open spaces. It provides general lighting for the residential areas where light pollution has to be controlled. The bollard height can be customized according to specific requirement. An anchorage unit is available as an accessory.



Technical Data



Ordering Code :	7120-0-3-887-XX
Lamp :	LED
CCT :	3000 K
CRI :	CRI >80
SDCM :	SDCM = 3
Lamp Lumen :	3300 lm
Luminaire Lumen :	1990 lm
Lamp Wattage :	23 W
Luminaire Wattage :	27 W
Efficacy :	73 lm/W
Ambient Temperature :	50°C
Lumen Maintenance	L70B10 >90,000 h
Controller :	On-Off
Input Voltage :	220-240Vac 50/60Hz
Net Weight :	6.40 kg.

Ordering code guide

XXXX-X-X-XXX-XX

B
D



















A
C
E

- A Product Code
- B Reflector
- C Electrical Component
- D Lamp
- E Color



Icon definition

Specification

IEC Standard	IEC 60598-1 General Requirement IEC 60598-2-1 Fixed Luminaires												
Protection	IP65 Class II												
IK Rating	Protection against mechanical impact IK08 on body and IK10 optical part.												
Luminaires Body Housing	High-pressure die cast aluminum alloy body and components. Extruded aluminum 56063 alloy body with low copper content.												
Coating Process	Nano Ceramic surface conversion, resistant to corrosive environment. Luminaire primarily coated with epoxy resin and top coated with UV stabilized polyester powder and cured in digital temperature controlled chamber at 200°C.												
Diffuser	Self-extinguishing high impact resistant clear polycarbonate diffuser with UV stabilized additive.												
Reflector	Glare shield slanted aluminum louvers.												
Gasket	Weather resistant silicone gasket. Working temperature -40°C to +200°C.												
External Screws	External screws are in stainless steel with protection grease.												
Cable Entry	Cable entry protected by weather proof grommet. To be used with HO5RN-F/ HO7RN-F cable with 6-13mm. diameter.												
Led	High efficiency LED module in COB technology. Assembled on MCPCB and mounted on to heat conductive material.												
Driver	High quality constant current LED driver. Conform to safety standard and electromagnetic compatibility standard.												
Internal Wire	Tinned copper conductor with silicone insulated internal wire. IMQ approved. Working temperature -40°C to +180°C.												
Terminal Block	Terminal block in GFR PA6.6 for cable with cross section up to 2.5 sqmm. VDE approved.												
Pre-Wire Cable	Pre-wired with 2x1.0 sqmm. HO7RN-F neoprene cable. IMQ approved. Equipped with anti-humidity kit.												
Caution	Installation work has to be carried on according to the enclosed installation manual.												
Color	<table border="0"> <tr> <td></td> <td>Black O1</td> </tr> <tr> <td></td> <td>Graphite O2</td> </tr> <tr> <td></td> <td>Dark Grey O3</td> </tr> <tr> <td></td> <td>Aluminum Silver O4</td> </tr> <tr> <td></td> <td>White O6</td> </tr> <tr> <td></td> <td>Wooden Brown O7</td> </tr> </table>		Black O1		Graphite O2		Dark Grey O3		Aluminum Silver O4		White O6		Wooden Brown O7
	Black O1												
	Graphite O2												
	Dark Grey O3												
	Aluminum Silver O4												
	White O6												
	Wooden Brown O7												

Light Distribution

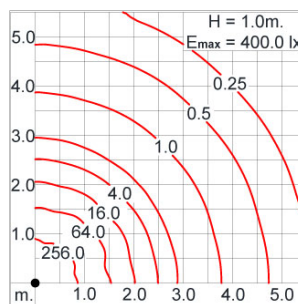
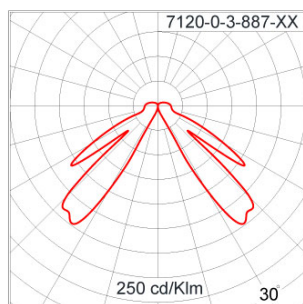

FUJI

DOUBLE FUJI ROUND BOLLARD



LAST UPDATE: 13-09-2024

Bug Report

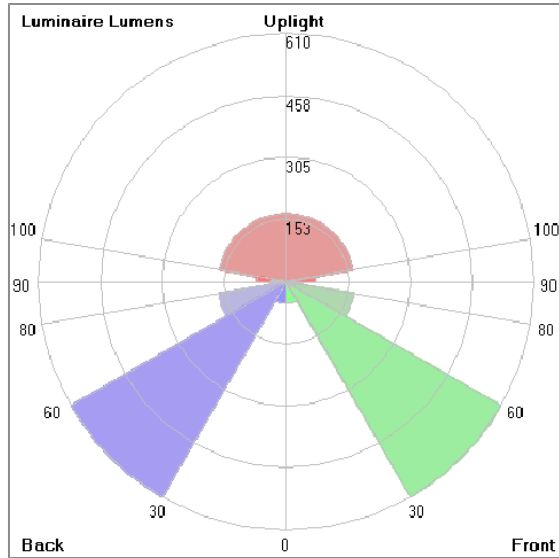

Lum. Classification System [LCS]

LCS	Zone	%Lumens	%Lamp	%Lum
FL	[0-30]	54.3	1.6	2.7
FM	[30-60]	610.3	18.5	30.8
FH	[60-80]	168.3	5.1	8.5
FVH	[80-90]	40.3	1.2	2.0
BL	[0-30]	54.3	1.6	2.7
BM	[30-60]	610.3	18.5	30.8
BH	[60-80]	168.3	5.1	8.5
BVH	[80-90]	40.3	1.2	2.0
UL	[90-100]	71.8	2.2	3.6
UH	[100-180]	166.0	5.0	8.4
Total		1984.2	60.0	100.0
BUG Rating		B1-U3-G1		

*Due to the constancy of product development,
we reserve the right to alter all specification
without prior notice.

Unilamp Co., Ltd.
461 Ramintra Road, Kannayao, Bangkok 10230 Thailand
Tel : +66(0)2 943 2420-1, +66(0)2 946 4170-1
Fax : +66(0)2 943 2419
online@unilamp.co.th
www.unilamp.co.th

Accessories



Ordering Code:
AUN-CON-0009-00
IP68 connection device,
cable diameter 5-9.5mm,
On-Off



Ordering Code:
AUN-CON-0010-00
IP68 connection device 3
pole, cable diameter
5-9.5mm, with distribution
block



Ordering Code:
AUN-CON-0013-00
IP68 connection device,
cable diameter 7-11.5mm,
On-Off

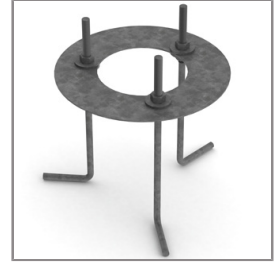

Ordering Code:
AUN-ACB-0001-00
Anchor bolt kit, bollard

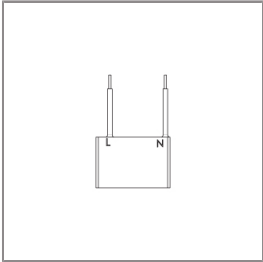

Ordering Code:
AUN-SUR-0004-00
Surge protection, 10kV,
On-Off, pre-assembly from
factory