

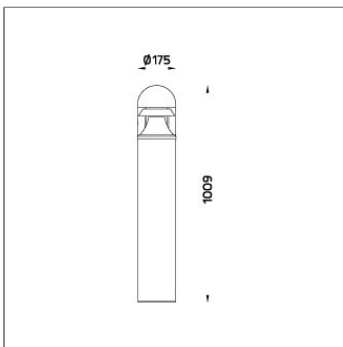

FUJI is a family of shielded bollard with symmetrical light distribution. FUJI is fitted with the latest generation of COB LED with exceptional color consistency. The family is also available in HID version and with E27 holder for Led retrofit lamps. It is generally installed in walkways, parks, commercial areas and open spaces. It provides general lighting for the residential areas where light pollution has to be controlled. The bollard height can be customized according to specific requirement. An anchorage unit is available as an accessory.



Technical Data



Ordering Code :	7120-0-3-505-XX
Lamp :	LED
CCT :	2700 K
CRI :	CRI >80
SDCM :	SDCM = 3
Lamp Lumen :	4590 lm
Luminaire Lumen :	2760 lm
Lamp Wattage :	36 W
Luminaire Wattage :	39 W
Efficacy :	70 lm/W
Ambient Temperature :	40°C
Lumen Maintenance	L70B10 >90,000 h
Controller :	On-Off
Input Voltage :	220-240Vac 50/60Hz
Net Weight :	6.40 kg.

Ordering code guide

XXXX-X-X-XXX-XX

B
D

A
C
E

- A Product Code
- B Reflector
- C Electrical Component
- D Lamp
- E Color



Icon definition

Specification

IEC Standard	IEC 60598-1 General Requirement IEC 60598-2-1 Fixed Luminaires										
Protection	IP65 Class II										
IK Rating	Protection against mechanical impact IK08 on body and IK10 optical part.										
Luminaires Body Housing	High-pressure die cast aluminum alloy body and components. Extruded aluminum 6063 alloy body with low copper content.										
Coating Process	Nano Ceramic surface conversion, resistant to corrosive environment. Luminaire primarily coated with epoxy resin and top coated with UV stabilized polyester powder and cured in digital temperature controlled chamber at 200°C.										
Diffuser	Self-extinguishing high impact resistant clear polycarbonate diffuser with UV stabilized additive.										
Reflector	Glare shield slanted aluminum louvers.										
Gasket	Weather resistant silicone gasket. Working temperature -40°C to +200°C.										
External Screws	External screws are in stainless steel with protection grease.										
Cable Entry	Cable entry protected by weather proof grommet. To be used with HO5RN-F/ HO7RN-F cable with 6-13mm. diameter.										
Led	High efficiency LED module in COB technology. Assembled on MCPCB and mounted on to heat conductive material.										
Driver	High quality constant current LED driver. Conform to safety standard and electromagnetic compatibility standard.										
Internal Wire	Tinned copper conductor with silicone insulated internal wire. IMQ approved. Working temperature -40°C to +180°C.										
Terminal Block	Terminal block in GFR PA6.6 for cable with cross section up to 2.5 sqmm. VDE approved.										
Pre-Wire Cable	Pre-wired with 2x1.0 sqmm. HO7RN-F neoprene cable. IMQ approved. Equipped with anti-humidity kit.										
Caution	Installation work has to be carried on according to the enclosed installation manual.										
Color	<table border="0"> <tr> <td></td> <td>Black 01</td> </tr> <tr> <td></td> <td>Graphite 02</td> </tr> <tr> <td></td> <td>Dark Grey 03</td> </tr> <tr> <td></td> <td>Aluminum Silver 04</td> </tr> <tr> <td></td> <td>White 06</td> </tr> </table>		Black 01		Graphite 02		Dark Grey 03		Aluminum Silver 04		White 06
	Black 01										
	Graphite 02										
	Dark Grey 03										
	Aluminum Silver 04										
	White 06										

Light Distribution

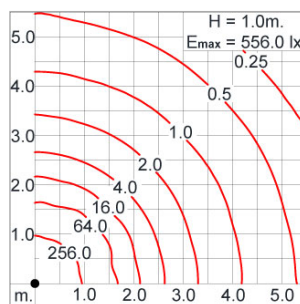
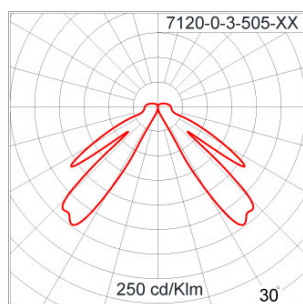

Bug Report

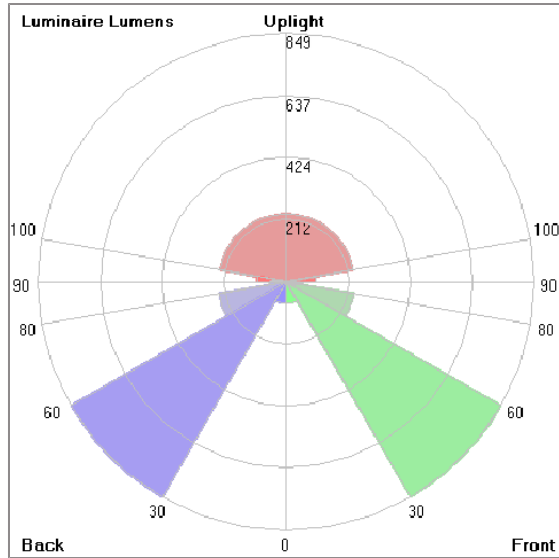

Lum. Classification System [LCS]

LCS	Zone	%Lumens	%Lamp	%Lum
FL	[0-30]	75.5	1.6	2.7
FM	[30-60]	848.9	18.5	30.8
FH	[60-80]	234.1	5.1	8.5
FVH	[80-90]	56.1	1.2	2.0
BL	[0-30]	75.5	1.6	2.7
BM	[30-60]	848.9	18.5	30.8
BH	[60-80]	234.1	5.1	8.5
BVH	[80-90]	56.1	1.2	2.0
UL	[90-100]	99.8	2.2	3.6
UH	[100-180]	230.9	5.0	8.4
Total		2759.9	60.0	100.0
BUG Rating		B1-U3-G1		

Accessories



Ordering Code:
AUN-CON-0009-00
IP68 connection device,
cable diameter 5-9.5mm,
On-Off



Ordering Code:
AUN-CON-0010-00
IP68 connection device 3
pole, cable diameter
5-9.5mm, with distribution
block



Ordering Code:
AUN-CON-0013-00
IP68 connection device,
cable diameter 7-11.5mm,
On-Off



Ordering Code:
AUN-ACB-0001-00
Anchor bolt kit, bollard