

RETINA

NEO MAXI RETINA 6

WALL SURFACE MOUNT



LAST UPDATE: 28-05-2024



RETINA is a round wall/ceiling light with robust aluminium construction and impact resistant polycarbonate diffuser. The LED module is available with built-in microwave motion sensor and hi-low light function. RETINA for compact fluorescent lamp and E27 holder for retrofit solution are also available. The high protection rating of IP65 and IK10 allows RETINA to be installed in rough outdoor environments. With a diffused light distribution, it provides smooth and uniform illumination in private and public areas and is also suitable for commercial use. The front cover is available in various designs; moreover, RETINA is available in two sizes with the choice of six different colors.

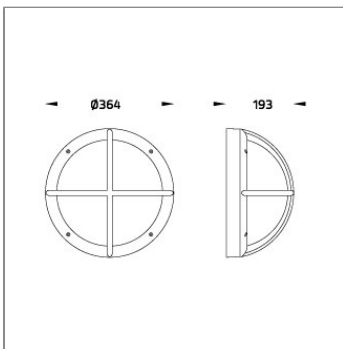

Technical Data



Ordering Code :	7085-0-3-810-XX
Lamp :	LED
CCT :	4000 K
CRI :	CRI >80
SDCM :	SDCM = 5
Lamp Lumen :	2550 lm
Luminaire Lumen :	1530 lm
Lamp Wattage :	23 W
Luminaire Wattage :	28 W
Efficacy :	54 lm/W
Ambient Temperature :	25°C
Lumen Maintenance	L70B10 >36,000 h
Controller :	On-Off with Microwave sensor
Input Voltage :	220-240Vac 50/60Hz
Net Weight :	3.40 kg.

Ordering code guide

XXXX-X-X-XXX-XX

A B C D E

- A Product Code
- B Reflector
- C Electrical Component
- D Lamp
- E Color



Icon definition

*Due to the constancy of product development, we reserve the right to alter all specification without prior notice.

Unilamp Co., Ltd.
461 Ramintra Road, Kannayao, Bangkok 10230 Thailand
Tel : +66(0)2 943 2420-1, +66(0)2 946 4170-1
Fax : +66(0)2 943 2419
online@unilamp.co.th
www.unilamp.co.th

RETINA

NEO MAXI RETINA 6

WALL SURFACE MOUNT



LAST UPDATE: 28-05-2024

Specification

IEC Standard	IEC 60598-1 General Requirement IEC 60598-2-1 Fixed Luminaires												
Protection	IP65 Class II												
IK Rating	Protection against mechanical impact IK10 on body and optical part.												
Luminaires Body Housing	High-pressure die cast aluminum alloy body and components.												
Coating Process	Nano Ceramic surface conversion, resistant to corrosive environment. Luminaire primarily coated with epoxy resin and top coated with UV stabilized polyester powder and cured in digital temperature controlled chamber at 200°C.												
Diffuser	Self-extinguishing high impact resistant opal polycarbonate diffuser with UV stabilized additive.												
Gasket	Weather resistant silicone gasket. Working temperature -40°C to +200°C.												
External Screws	External screws are in stainless steel with protection grease.												
Cable Entry	Cable entry protected by weather proof grommet. To be used with HO5RN-F/ HO7RN-F cable with 6-13mm. diameter.												
Led	High efficiency SMD LED module with built-in constant current LED driver. Replacable module for future upgrade or maintenance. Equipped with motion detector Microwave Sensor.												
Internal Wire	Tinned copper conductor with PTFE insulated internal wire. IMQ approved. Working temperature -40°C to +250°C.												
Terminal Block	Terminal block in GFR PA6.6 for cable with cross section up to 2.5 sqmm. VDE approved.												
Caution	Installation work has to be carried on according to the enclosed installation manual.												
Color	<table><tr><td></td><td>Black O1</td></tr><tr><td></td><td>Graphite O2</td></tr><tr><td></td><td>Dark Grey O3</td></tr><tr><td></td><td>Aluminum Silver O4</td></tr><tr><td></td><td>White O6</td></tr><tr><td></td><td>Wooden Brown O7</td></tr></table>		Black O1		Graphite O2		Dark Grey O3		Aluminum Silver O4		White O6		Wooden Brown O7
	Black O1												
	Graphite O2												
	Dark Grey O3												
	Aluminum Silver O4												
	White O6												
	Wooden Brown O7												

Light Distribution

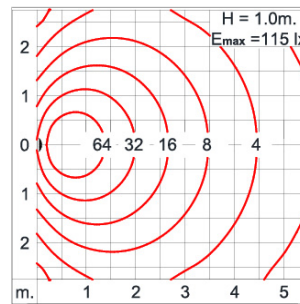
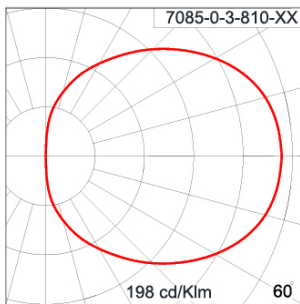

*Due to the constancy of product development, we reserve the right to alter all specification without prior notice.

Unilamp Co., Ltd.
461 Ramintra Road, Kannayao, Bangkok 10230 Thailand
Tel : +66(0)2 943 2420-1, +66(0)2 946 4170-1
Fax : +66(0)2 943 2419
online@unilamp.co.th
www.unilamp.co.th