

# CETUS

## MINI CETUS – U BRACKET

### SPOTLIGHT



LAST UPDATE: 08-05-2026

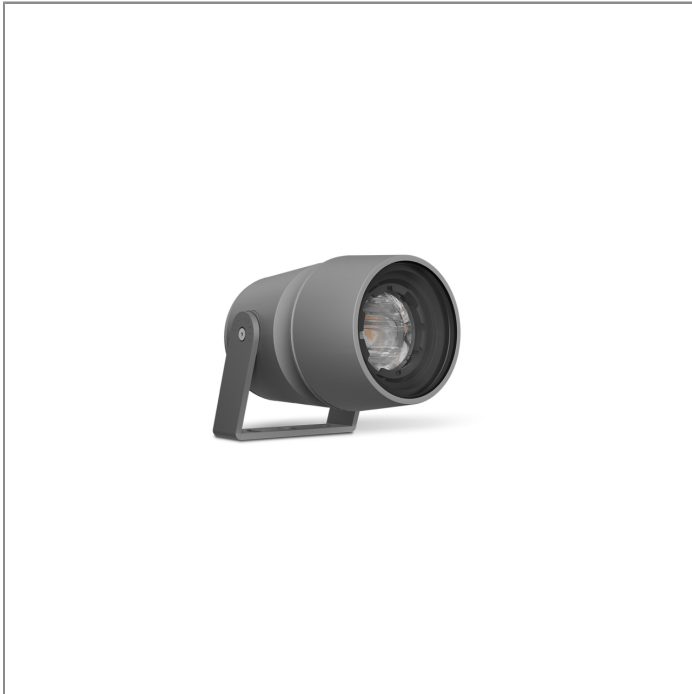

CETUS is the next generation circular shaped projector designed for strict energy efficiency requirements as well as modular and versatile use cases. The control gear lifetime is extended by thermal isolation from the light source. The optional built in surge protection device reinforces CETUS ability to withstand toughest ambient conditions. CETUS is equipped with the Vent to rapidly equalize pressure potential in case of rapidly changing ambient conditions. Ultra-tough silica-boron trioxide glass is used for superior chemical resistance and class leading IK09 impact resistance. The Unilamp modular solutions system allows adoption of CETUS to any type of installation requirement even years after delivery. Circular economy assessment according to CIBSE TM66 is available on request.

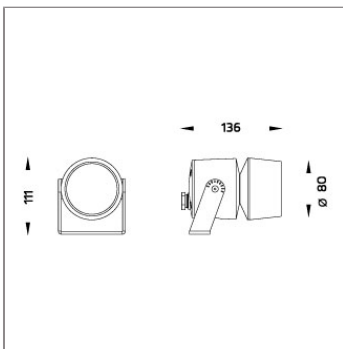

## Technical Data



Ordering Code :	5996-H-3-886-XX
Lamp :	COB LED
Beam :	50°/22°
CCT :	3000 K
CRI :	CRI >80
SDCM :	SDCM = 3
Lamp Lumen :	1390 lm
Luminaire Lumen :	1110 lm
Lamp Wattage :	8.1 W
Luminaire Wattage :	8.8 W
Efficacy :	126 lm/W
Ambient Temperature :	50°C
Lumen Maintenance	L70B10 >60,000 h
Controller :	On-Off
Input Voltage :	220-240Vac 50/60Hz
Net Weight :	- kg.

### Ordering code guide

XXXX-X-X-XXX-XX  
A B C D E

- A Product Code
- B Reflector
- C Electrical Component
- D Lamp
- E Color





















Icon definition

\*Due to the constancy of product development, we reserve the right to alter all specification without prior notice.

Unilamp Co., Ltd.  
461 Ramintra Road, Kannayao, Bangkok 10230 Thailand  
Tel : +66(O)2 943 2420-1, +66(O)2 946 4170-1  
Fax : +66(O)2 943 2419  
online@unilamp.co.th  
www.unilamp.co.th

### Specification

IEC Standard	IEC 60598-1 General Requirement IEC 60598-2-1 Fixed Luminaires												
Protection	IP66 Class I												
IK Rating	Protection against mechanical impact IK10 on body and IK08 on optical part.												
Luminaires Body Housing	Durable high-pressure die-cast aluminum alloy for excellent mechanical performance.												
Coating Process	The luminaire undergoes a Nano Ceramic surface conversion, making it highly resistant to corrosive environments. It is primarily coated with a durable epoxy resin and finished with a UV-stabilized polyester powder top coat. The coating process is completed by curing the luminaire in a digitally controlled temperature chamber at 200°C, ensuring exceptional durability and long-lasting protection aga												
Diffuser	Impact-resistant tempered glass designed for high-temperature environments.												
Lens	Advanced molded PC lens offering diverse light distribution patterns.												
Adjustable Optic	Adjustable aiming mechanism with graduated scale for precision control.												
Gasket	Advanced post-cured silicone gasket offering superior weather and thermal resistance [-40°C to +200°C].												
External Screws	Durable stainless steel screws with anti-corrosion grease for extended lifespan.												
Cable Entry	M20 cable gland for secure cable entry, compatible with H05RN-F/H07RN-F cables (7-13mm).												
Led	COB LED module with high efficiency, mounted on MCPCB for superior thermal management.												
Driver	Certified constant current LED driver meeting all EMC and safety requirements.												
Internal Wire	Reliable silicone-insulated tinned copper internal wire, designed for -40°C to +180°C.												
Terminal Block	Certified GFR PA6.6 terminal block supporting up to 2.5 sqmm cables. Grounded Class 1 luminaire ensuring proper earthing for secure operation.												
Pre-Wire Cable	Certified pre-wired 3x1.0 sqmm cable, featuring H07RN-F neoprene insulation.												
Caution	Installation must be performed as per the provided installation instructions.												
Color	<table border="0"> <tr> <td></td> <td>Black O1</td> </tr> <tr> <td></td> <td>Graphite O2</td> </tr> <tr> <td></td> <td>Dark Grey O3</td> </tr> <tr> <td></td> <td>Aluminum Silver O4</td> </tr> <tr> <td></td> <td>White O6</td> </tr> <tr> <td></td> <td>Corten O8</td> </tr> </table>		Black O1		Graphite O2		Dark Grey O3		Aluminum Silver O4		White O6		Corten O8
	Black O1												
	Graphite O2												
	Dark Grey O3												
	Aluminum Silver O4												
	White O6												
	Corten O8												

### Light Distribution

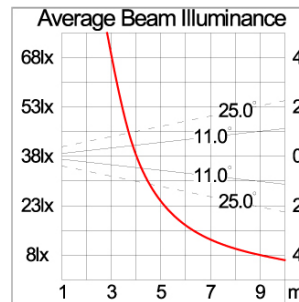
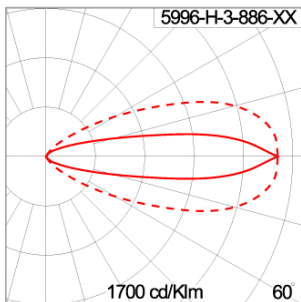

\*Due to the constancy of product development, we reserve the right to alter all specification without prior notice.

# CETUS

## MINI CETUS – U BRACKET SPOTLIGHT



LAST UPDATE: 08-05-2026

### Bug Report

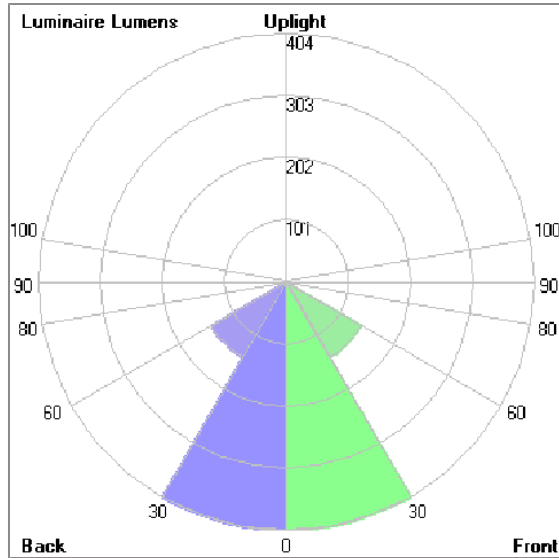

### Lum. Classification System (LCS)

LCS	Zone	%Lumens	%Lamp	%Lum
FL	[0-30]	403.7	29.0	36.6
FM	[30-60]	141.4	10.2	12.8
FH	[60-80]	6.6	0.5	0.6
FVH	[80-90]	0.2	0.0	0.0
BL	[0-30]	403.7	29.0	36.6
BM	[30-60]	141.4	10.2	12.8
BH	[60-80]	6.6	0.5	0.6
BVH	[80-90]	0.2	0.0	0.0
UL	[90-100]	0.0	0.0	0.0
UH	[100-180]	0.0	0.0	0.0
Total		1103.8	79.4	100.0
BUG Rating		B1-U0-G0		

\*Due to the constancy of product development,  
we reserve the right to alter all specification  
without prior notice.

# CETUS

## MINI CETUS – U BRACKET

### SPOTLIGHT



LAST UPDATE: 08-05-2026

#### Accessories



Ordering Code:  
AUN-CON-0009-00  
IP68 connection device,  
cable diameter 5-9.5mm,  
On-Off



Ordering Code:  
AUN-CON-0013-00  
IP68 connection device,  
cable diameter 7-11.5mm,  
On-Off



Ordering Code:  
AUN-GSH-0057-XX  
Glare shield cap,  
pre-assembly from factory

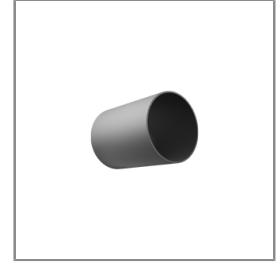

Ordering Code:  
AUN-GSH-0058-XX  
Snoot, pre-assembly from  
factory

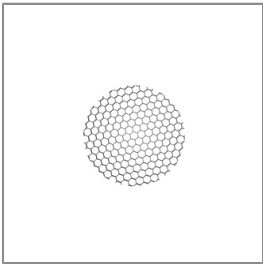

Ordering Code:  
AUN-GSH-0043-00  
Honeycomb louver, COB,  
pre-assembly from factory

\*Due to the constancy of product development,  
we reserve the right to alter all specification  
without prior notice.

Unilamp Co., Ltd.  
461 Ramintra Road, Kannayao, Bangkok 10230 Thailand  
Tel : +66[0]2 943 2420-1, +66[0]2 946 4170-1  
Fax : +66[0]2 943 2419  
online@unilamp.co.th  
www.unilamp.co.th