

# CETUS

## MEGA CETUS – WITHOUT BASE PROJECTOR



LAST UPDATE: 27-03-2025



CETUS is the next generation circular shaped projector designed for strict energy efficiency requirements as well as modular and versatile use cases. The control gear lifetime is extended by thermal isolation from the light source. The optional built in surge protection device reinforces CETUS ability to withstand toughest ambient conditions. CETUS is equipped with the Vent to rapidly equalize pressure potential in case of rapidly changing ambient conditions. Ultra-tough silica-boron trioxide glass is used for superior chemical resistance and class leading IK09 impact resistance. The Unilamp modular solutions system allows adoption of CETUS to any type of installation requirement even years after delivery. Circular economy assessment according to CIBSE TM66 is available on request.

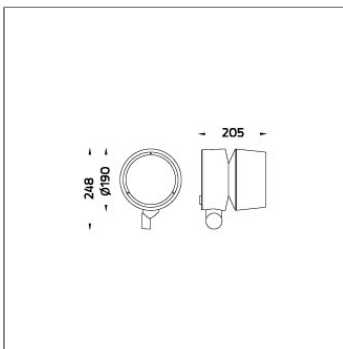

### Technical Data



Ordering Code :	5994-D-3-506-XX
Lamp :	LED
Beam :	55°
CCT :	2700 K
CRI :	CRI >80
SDCM :	SDCM = 3
Lamp Lumen :	4750 lm
Luminaire Lumen :	3190 lm
Lamp Wattage :	31 W
Luminaire Wattage :	36 W
Efficacy :	88 lm/W
Lumen Maintenance	L70B10 >60,000 h
Controller :	On-Off
Input Voltage :	220-240Vac 50/60Hz
Net Weight :	4.20 kg.

#### Ordering code guide

XXXX-X-X-XXX-XX

A B C D E

- A Product Code
- B Reflector
- C Electrical Component
- D Lamp
- E Color



Icon definition

\*Due to the constancy of product development, we reserve the right to alter all specification without prior notice.

Unilamp Co., Ltd.  
461 Ramintra Road, Kannayao, Bangkok 10230 Thailand  
Tel : +66(0)2 943 2420-1, +66(0)2 946 4170-1  
Fax : +66(0)2 943 2419  
online@unilamp.co.th  
www.unilamp.co.th

# CETUS

## MEGA CETUS – WITHOUT BASE PROJECTOR



LAST UPDATE: 27-03-2025

### Specification

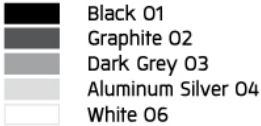
IEC Standard	IEC 60598-1 General Requirement IEC 60598-2-1 Fixed Luminaires
Protection	IP66 Class I
IK Rating	Protection against mechanical impact IK10 on body and IK08 on optical part.
Luminaires Body Housing	High-pressure die cast aluminum alloy body and components.
Coating Process	Nano Ceramic surface conversion, resistant to corrosive environment. Luminaire primarily coated with epoxy resin and top coated with UV stabilized polyester powder and cured in digital temperature controlled chamber at 200°C.
Diffuser	Impact resistant safety tempered glass cover. Able to withstand the temperature up to 250°C.
Lens	Molded PC lens from renowned manufacturers in various light distribution patterns.
Adjustable Optic	Adjustable aiming unit through graduated scale.
Gasket	Post-cured treated silicone gasket. Temperature and weather resistant. Working temperature -40°C to +200°C.
External Screws	External screws are in stainless steel with protection grease.
Cable Entry	Cable entry protected by M20 cable gland. To be used with H05RN-F/ H07RN-F cable with 7-13mm. diameter.
Led	High efficiency LED module in COB technology. Assembled on MCPCB and mounted on to heat conductive material.
Driver	High quality constant current LED driver. Conform to safety standard and electromagnetic compatibility standard.
Internal Wire	Tinned copper conductor with silicone insulated internal wire. IMQ approved. Working temperature -40°C to +180°C.
Terminal Block	Terminal block in GFR PA6.6 for cable with cross section up to 2.5 sqmm. VDE approved. Class1 luminaire provided with the earth connection.
Pre-Wire Cable	Pre-wired with 3x1.0 sqmm. H07RN-F neoprene cable. IMQ approved.
Caution	Installation work has to be carried on according to the enclosed installation manual.
Color	 Black O1 Graphite O2 Dark Grey O3 Aluminum Silver O4 White O6

### Light Distribution

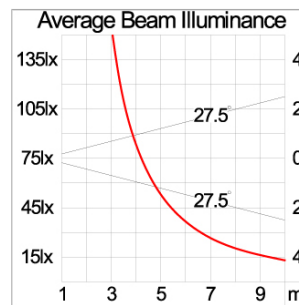
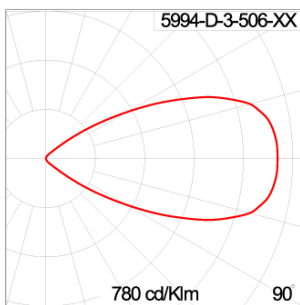

\*Due to the constancy of product development,  
we reserve the right to alter all specification  
without prior notice.

Unilamp Co., Ltd.  
461 Ramintra Road, Kannayao, Bangkok 10230 Thailand  
Tel : +66(0)2 943 2420-1, +66(0)2 946 4170-1  
Fax : +66(0)2 943 2419  
online@unilamp.co.th  
www.unilamp.co.th

# CETUS

## MEGA CETUS – WITHOUT BASE PROJECTOR



LAST UPDATE: 27-03-2025

### Accessories



Ordering Code:  
AUN-ACB-0014-00  
Anchor bolt kit, bollard



Ordering Code:  
AUN-CON-0009-00  
IP68 connection device,  
cable diameter 5-9.5mm,  
On-Off



Ordering Code:  
AUN-CON-0013-00  
IP68 connection device,  
cable diameter 7-11.5mm,  
On-Off



Ordering Code:  
AUN-GSH-0056-00  
Honeycomb louver, LED,  
pre-assembly from factory

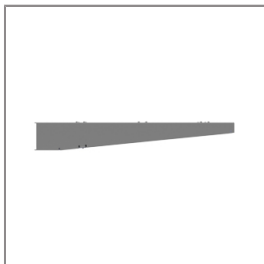

Ordering Code:  
AUN-MOT-0013-XX  
Pole mounting arm, for 1-3  
projector

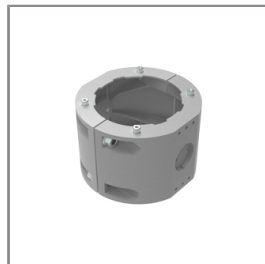

Ordering Code:  
AUN-CLP-0008-XX  
Pole clamp, pole diameter  
102-105mm, for wall or  
pole mounting arm

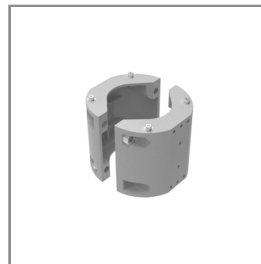

Ordering Code:  
AUN-CLP-0009-XX  
Pole clamp, pole diameter  
60-76mm, for wall or pole  
mounting arm



Ordering Code:  
AUN-ESP-0001-00  
Earth spike, GFR polymer



Ordering Code:  
AUN-TRS-0001-00  
Tree strap, small mounting  
base



Ordering Code:  
AUN-ACB-0008-00  
Anchor bolt kit, pole  
diameter 102mm and  
151x102mm, galvanized  
steel pole



Ordering Code:  
AUN-ACB-0005-00  
Anchor bolt kit, aluminum  
pole



Ordering Code:  
AUN-MOT-0021-XX  
Mounting base, rotateable,  
On-Off, pre-assembly from  
factory

\*Due to the constancy of product development,  
we reserve the right to alter all specification  
without prior notice.

Unilamp Co., Ltd.  
461 Ramintra Road, Kannayao, Bangkok 10230 Thailand  
Tel : +66[0]2 943 2420-1, +66[0]2 946 4170-1  
Fax : +66[0]2 943 2419  
online@unilamp.co.th  
www.unilamp.co.th

# CETUS

## MEGA CETUS – WITHOUT BASE PROJECTOR



LAST UPDATE: 27-03-2025



Ordering Code:  
AUN-POL-0043-XX  
Cylindrical aluminum pole,  
diameter 105mm, H=  
522mm, [pre-assembled  
from factory]

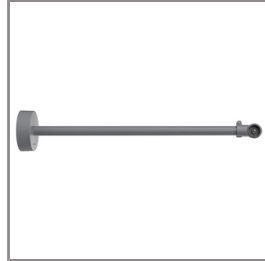

Ordering Code:  
AUN-MOT-0018-XX  
Outrigger arm, L= 740mm,  
On-Off, pre-assembly from  
factory



Ordering Code:  
AUN-ESP-0008-XX  
Earth spike, L= 900mm,  
aluminum, On-Off,  
pre-assembly from factory

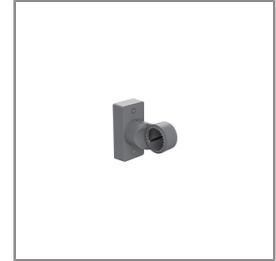

Ordering Code:  
AUN-MOT-0038-XX  
Pole mount adaptor,  
rectangular pole, On-Off,  
pre-assembly from factory

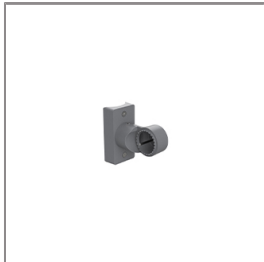

Ordering Code:  
AUN-MOT-0032-XX  
Pole mount adaptor, pole  
diameter 60mm, On-Off,  
pre-assembly from factory

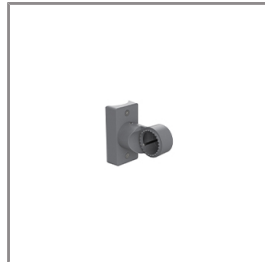

Ordering Code:  
AUN-MOT-0034-XX  
Pole mount adaptor, pole  
diameter 76mm, On-Off,  
pre-assembly from factory

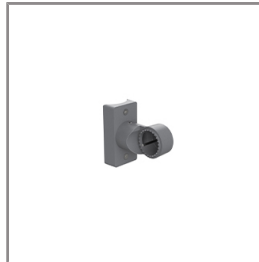

Ordering Code:  
AUN-MOT-0036-XX  
Pole mount adaptor, pole  
diameter 102-105mm,  
On-Off, pre-assembly from  
factory



Ordering Code:  
AUN-CLP-0040-XX  
Pole clamp, pole diameter  
60-76mm, single side  
luminaire mounting ,  
On-Off, pre-assembly from  
factory



Ordering Code:  
AUN-CLP-0042-XX  
Pole clamp, pole diameter  
102-105mm, single side  
luminaire mounting ,  
On-Off, pre-assembly from  
factory

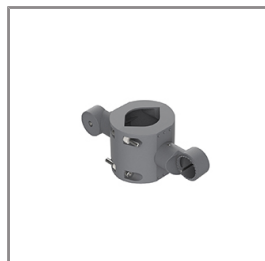

Ordering Code:  
AUN-CLP-0044-XX  
Pole clamp, pole diameter  
60-76mm, double sided  
luminaire mounting ,  
On-Off, pre-assembly from  
factory

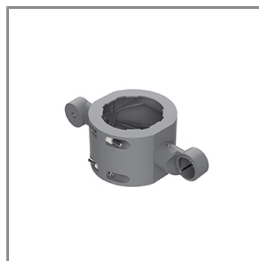

Ordering Code:  
AUN-CLP-0046-XX  
Pole clamp, pole diameter  
102-105mm, double sided  
luminaire mounting ,  
On-Off, pre-assembly from  
factory



Ordering Code:  
AUN-ESP-0023-XX  
Earth spike, L=  
1390-1760mm, aluminum,  
length adjustable, On-Off,  
pre-assembly from factory

\*Due to the constancy of product development,  
we reserve the right to alter all specification  
without prior notice.

Unilamp Co., Ltd.  
461 Ramintra Road, Kannayao, Bangkok 10230 Thailand  
Tel : +66[0]2 943 2420-1, +66[0]2 946 4170-1  
Fax : +66[0]2 943 2419  
online@unilamp.co.th  
www.unilamp.co.th

# CETUS

## MEGA CETUS – WITHOUT BASE PROJECTOR



LAST UPDATE: 27-03-2025



Ordering Code:

ALUMINUM-POLE-FOR-CETUS-SPOTLIGHT

Please contact Sales  
Representative



Ordering Code:

STEEL-POLE-FOR-CETUS-SPOTLIGHT

Please contact Sales  
Representative

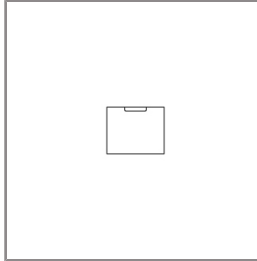

Ordering Code:

AUN-SUR-0001-00

Surge protection, 10kV,  
On-Off, pre-assembly from  
factory



Ordering Code:

AUN-GSH-0049-XX

Glare shield cap



Ordering Code:

AUN-GSH-0051-XX

Snoot

\*Due to the constancy of product development,  
we reserve the right to alter all specification  
without prior notice.

Unilamp Co., Ltd.  
461 Ramintra Road, Kannayao, Bangkok 10230 Thailand  
Tel : +66[0]2 943 2420-1, +66[0]2 946 4170-1  
Fax : +66[0]2 943 2419  
online@unilamp.co.th  
www.unilamp.co.th