

# CETUS

## MEGA CETUS – WITHOUT BASE

### SPOTLIGHT



LAST UPDATE: 20-06-2025



CETUS is the next generation circular shaped projector designed for strict energy efficiency requirements as well as modular and versatile use cases. The control gear lifetime is extended by thermal isolation from the light source. The optional built in surge protection device reinforces CETUS ability to withstand toughest ambient conditions. CETUS is equipped with the Vent to rapidly equalize pressure potential in case of rapidly changing ambient conditions. Ultra-tough silica-boron trioxide glass is used for superior chemical resistance and class leading IK09 impact resistance. The Unilamp modular solutions system allows adoption of CETUS to any type of installation requirement even years after delivery. Circular economy assessment according to CIBSE TM66 is available on request.

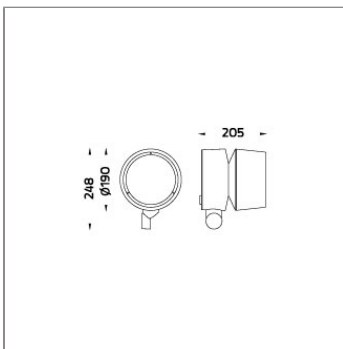

### Technical Data



|                       |                    |
|-----------------------|--------------------|
| Ordering Code :       | 5994-B-5-891-XX    |
| Lamp :                | LED                |
| Beam :                | 24°                |
| CCT :                 | 4000 K             |
| CRI :                 | CRI >80            |
| SDCM :                | SDCM = 3           |
| Lamp Lumen :          | 5190 lm            |
| Luminaire Lumen :     | 4000 lm            |
| Lamp Wattage :        | 31 W               |
| Luminaire Wattage :   | 36 W               |
| Efficacy :            | 111 lm/W           |
| Ambient Temperature : | 50°C               |
| Lumen Maintenance     | L70B10 >60,000 h   |
| Controller :          | DALI               |
| Input Voltage :       | 220-240Vac 50/60Hz |
| Net Weight :          | 4.20 kg.           |

#### Ordering code guide

XXXX-X-X-XXX-XX

- A Product Code
- B Reflector
- C Electrical Component
- D Lamp
- E Color

















Icon definition

\*Due to the constancy of product development, we reserve the right to alter all specification without prior notice.

Unilamp Co., Ltd.  
461 Ramintra Road, Kannayao, Bangkok 10230 Thailand  
Tel : +66(O)2 943 2420-1, +66(O)2 946 4170-1  
Fax : +66(O)2 943 2419  
online@unilamp.co.th  
www.unilamp.co.th

### Specification

|   |  |   |          |   |             |   |              |   |                    |   |          |
|---|--|---|----------|---|-------------|---|--------------|---|--------------------|---|----------|
| IEC Standard  | IEC 60598-1 General Requirement<br>IEC 60598-2-1 Fixed Luminaires  |   |          |   |             |   |              |   |                    |   |          |
| Protection  | IP66 Class I   |   |          |   |             |   |              |   |                    |   |          |
| IK Rating   | Protection against mechanical impact IK10 on body and IK08 on optical part.  |   |          |   |             |   |              |   |                    |   |          |
| Luminaires Body Housing   | High-pressure die cast aluminum alloy body and components.   |   |          |   |             |   |              |   |                    |   |          |
| Coating Process   | Nano Ceramic surface conversion, resistant to corrosive environment. Luminaire primarily coated with epoxy resin and top coated with UV stabilized polyester powder and cured in digital temperature controlled chamber at 200°C.  |   |          |   |             |   |              |   |                    |   |          |
| Diffuser  | Impact resistant safety tempered glass cover. Able to withstand the temperature up to 250°C.   |   |          |   |             |   |              |   |                    |   |          |
| Lens  | Molded PC lens from renowned manufacturers in various light distribution patterns.   |   |          |   |             |   |              |   |                    |   |          |
| Adjustable Optic  | Adjustable aiming unit through graduated scale.  |   |          |   |             |   |              |   |                    |   |          |
| Gasket  | Post-cured treated silicone gasket. Temperature and weather resistant. Working temperature -40°C to +200°C.  |   |          |   |             |   |              |   |                    |   |          |
| External Screws   | External screws are in stainless steel with protection grease.   |   |          |   |             |   |              |   |                    |   |          |
| Cable Entry   | Cable entry protected by M20 cable gland. To be used with H05RN-F/ H07RN-F cable with 7-13mm. diameter.  |   |          |   |             |   |              |   |                    |   |          |
| Led   | High efficiency LED module in COB technology. Assembled on MCPCB and mounted on to heat conductive material.   |   |          |   |             |   |              |   |                    |   |          |
| Driver  | High quality DALI driver in constant current. Conform to applicable safety standards and electromagnetic compatibility.  |   |          |   |             |   |              |   |                    |   |          |
| Internal Wire   | Tinned copper conductor with silicone insulated internal wire. IMQ approved. Working temperature -40°C to +180°C.  |   |          |   |             |   |              |   |                    |   |          |
| Terminal Block  | Terminal block in GFR PA6.6 for cable with cross section up to 2.5 sqmm. VDE approved.<br>Class1 luminaire provided with the earth connection.   |   |          |   |             |   |              |   |                    |   |          |
| Pre-Wire Cable  | Pre-wired with 5-core cable for power (3x1 sqmm.) and dimming signal (2x1 sqmm.).  |   |          |   |             |   |              |   |                    |   |          |
| Caution   | Installation work has to be carried on according to the enclosed installation manual.  |   |          |   |             |   |              |   |                    |   |          |
| Color   | <table border="0"> <tr> <td></td> <td>Black O1</td> </tr> <tr> <td></td> <td>Graphite O2</td> </tr> <tr> <td></td> <td>Dark Grey O3</td> </tr> <tr> <td></td> <td>Aluminum Silver O4</td> </tr> <tr> <td></td> <td>White O6</td> </tr> </table> |  | Black O1 |  | Graphite O2 |  | Dark Grey O3 |  | Aluminum Silver O4 |  | White O6 |
|  | Black O1   |   |          |   |             |   |              |   |                    |   |          |
|  | Graphite O2  |   |          |   |             |   |              |   |                    |   |          |
|  | Dark Grey O3   |   |          |   |             |   |              |   |                    |   |          |
|  | Aluminum Silver O4   |   |          |   |             |   |              |   |                    |   |          |
|  | White O6   |   |          |   |             |   |              |   |                    |   |          |

### Light Distribution

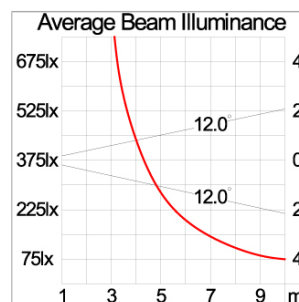
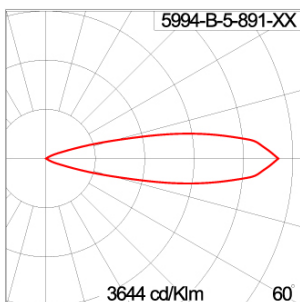

# CETUS

## MEGA CETUS – WITHOUT BASE

### SPOTLIGHT



LAST UPDATE: 20-06-2025

#### Accessories



Ordering Code:  
AUN-ACB-0014-00  
Anchor bolt kit, bollard



Ordering Code:  
AUN-CON-0011-00  
IP68 connection device,  
cable diameter 7.1-13mm,  
1-10V or DALI



Ordering Code:  
AUN-CON-0014-00  
IP68 connection device,  
cable diameter 8-12.5mm,  
1-10V or DALI

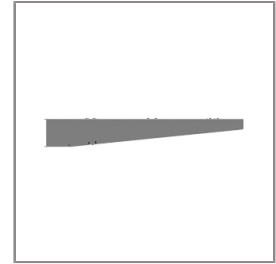

Ordering Code:  
AUN-MOT-0013-XX  
Pole mounting arm, for 1-3  
projector

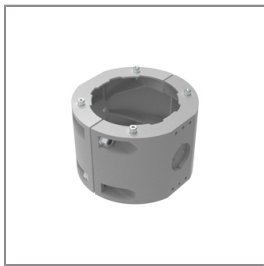

Ordering Code:  
AUN-CLP-0008-XX  
Pole clamp, pole diameter  
102-105mm, for wall or  
pole mounting arm

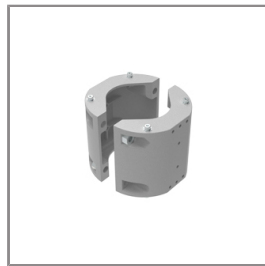

Ordering Code:  
AUN-CLP-0009-XX  
Pole clamp, pole diameter  
60-76mm, for wall or pole  
mounting arm



Ordering Code:  
AUN-ESP-0001-00  
Earth spike, GFR polymer



Ordering Code:  
AUN-TRS-0001-00  
Tree strap, small mounting  
base



Ordering Code:  
AUN-ACB-0008-00  
Anchor bolt kit, pole  
diameter 102mm and  
151x102mm, galvanized  
steel pole



Ordering Code:  
AUN-ACB-0005-00  
Anchor bolt kit, aluminum  
pole



Ordering Code:  
AUN-MOT-0022-XX  
Mounting base, rotateable,  
1-10V or DALI,  
pre-assembly from factory



Ordering Code:  
AUN-POL-0044-XX  
Cylindrical aluminum pole,  
diameter 105mm, H=  
522mm, 1-10V / DALI  
[pre-assembled from  
factory]

\*Due to the constancy of product development,  
we reserve the right to alter all specification  
without prior notice.

Unilamp Co., Ltd.  
461 Ramintra Road, Kannayao, Bangkok 10230 Thailand  
Tel : +66[0]2 943 2420-1, +66[0]2 946 4170-1  
Fax : +66[0]2 943 2419  
online@unilamp.co.th  
www.unilamp.co.th

# CETUS

## MEGA CETUS – WITHOUT BASE

### SPOTLIGHT



LAST UPDATE: 20-06-2025



Ordering Code:  
AUN-MOT-0019-XX  
Outtrigger arm, L= 740mm,  
1-10V or DALI,  
pre-assembly from factory



Ordering Code:  
AUN-ESP-0009-XX  
Earth spike, L= 900mm,  
aluminum, 1-10V or DALI,  
pre-assembly from factory

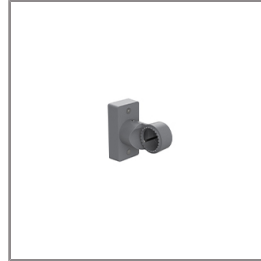

Ordering Code:  
AUN-MOT-0039-XX  
Pole mount adaptor,  
rectangular pole, 1-10V or  
DALI, pre-assembly from  
factory

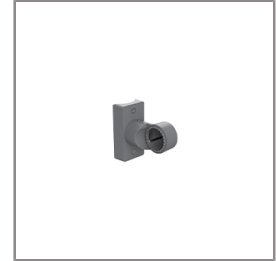

Ordering Code:  
AUN-MOT-0033-XX  
Pole mount adaptor, pole  
diameter 60mm, 1-10V or  
DALI, pre-assembly from  
factory

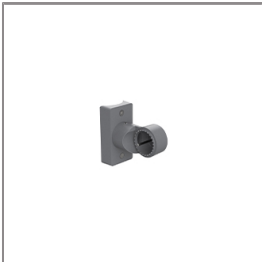

Ordering Code:  
AUN-MOT-0035-XX  
Pole mount adaptor, pole  
diameter 76mm, 1-10V or  
DALI, pre-assembly from  
factory

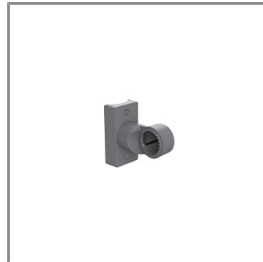

Ordering Code:  
AUN-MOT-0037-XX  
Pole mount adaptor, pole  
diameter 102-105mm,  
1-10V or DALI,  
pre-assembly from factory



Ordering Code:  
AUN-CLP-0041-XX  
Pole clamp, pole diameter  
60-76mm, single side  
luminaire mounting , 1-10V  
or DALI, pre-assembly from  
factory



Ordering Code:  
AUN-CLP-0043-XX  
Pole clamp, pole diameter  
102-105mm, single side  
luminaire mounting , 1-10V  
or DALI, pre-assembly from  
factory



Ordering Code:  
AUN-CLP-0045-XX  
Pole clamp, pole diameter  
60-76mm, double sided  
luminaire mounting , 1-10V  
or DALI, pre-assembly from  
factory

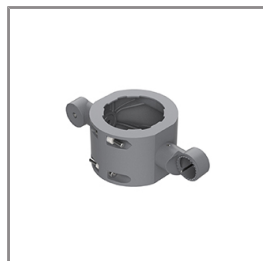

Ordering Code:  
AUN-CLP-0047-XX  
Pole clamp, pole diameter  
102-105mm, double sided  
luminaire mounting , 1-10V  
or DALI, pre-assembly from  
factory

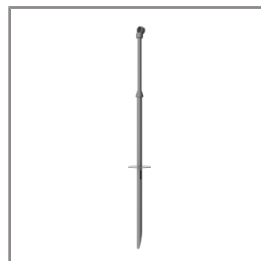

Ordering Code:  
AUN-ESP-0024-XX  
Earth spike, L=  
1390-1760mm, aluminum,  
length adjustable, 1-10V or  
DALI, pre-assembly from  
factory



Ordering Code:  
ALUMINUM-POLE-FOR-CETUS-SPOTLIGHT  
Please contact Sales  
Representative

\*Due to the constancy of product development,  
we reserve the right to alter all specification  
without prior notice.

Unilamp Co., Ltd.  
461 Ramintra Road, Kannayao, Bangkok 10230 Thailand  
Tel : +66(0)2 943 2420-1, +66(0)2 946 4170-1  
Fax : +66(0)2 943 2419  
online@unilamp.co.th  
www.unilamp.co.th

# CETUS

## MEGA CETUS – WITHOUT BASE

### SPOTLIGHT



LAST UPDATE: 20-06-2025



Ordering Code:  
STEEL-POLE-FOR-CETUS-SPOTLIGHT  
Please contact Sales  
Representative

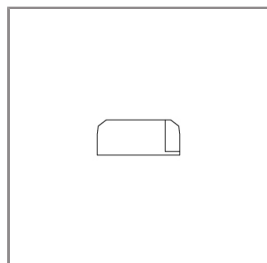

Ordering Code:  
AUN-SUR-0002-00  
Surge protection, 10kV,  
DALI, pre-assembly from  
factory



Ordering Code:  
AUN-GSH-0049-XX  
Glare shield cap

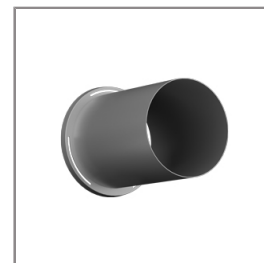

Ordering Code:  
AUN-GSH-0051-XX  
Snoot

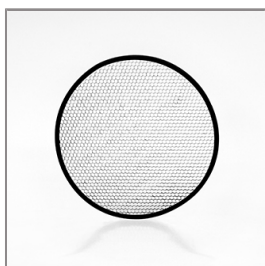

Ordering Code:  
AUN-GSH-0056-00  
Honeycomb louver, LED,  
pre-assembly from factory

\*Due to the constancy of product development,  
we reserve the right to alter all specification  
without prior notice.

Unilamp Co., Ltd.  
461 Ramintra Road, Kannayao, Bangkok 10230 Thailand  
Tel : +66[0]2 943 2420-1, +66[0]2 946 4170-1  
Fax : +66[0]2 943 2419  
online@unilamp.co.th  
www.unilamp.co.th