

ALPHA

MEDIUM ALPHA ROUND – ID SPOTLIGHT



LAST UPDATE: 25-05-2026



ALPHA is an entirely new family of outdoor spotlights/floodlights engineered from scratch. The primary shapes and overall small dimensions make it possible to install ALPHA in most professional and residential lighting applications. High-quality polycarbonate optics provide accurate beam control and offer a wide selection of light distributions. ALPHA can be customized with accessories such as honeycombs, shields and various mounting solutions for poles and surfaces. The minimized amount of needed tools and usage of quick connectors simplifies the installation.



Technical Data



Ordering Code :	5962-H-A-537-XX
Lamp :	LED
Beam :	46°/16°
CCT :	2700 K
CRI :	CRI >80
SDCM :	SDCM = 3
Lamp Lumen :	2300 lm
Luminaire Lumen :	1580 lm
Lamp Wattage :	18 W
Luminaire Wattage :	19 W
Efficacy :	83 lm/W
Ambient Temperature :	40°C
Lumen Maintenance	L80B10 >108,000 h
Controller :	CASAMBI
Input Voltage :	220-240Vac 50/60Hz
Net Weight :	1.40 kg.

Ordering code guide

XXXX-X-X-XXX-XX
A C E

- A Product Code
- B Reflector
- C Electrical Component
- D Lamp
- E Color



Icon definition

*Due to the constancy of product development, we reserve the right to alter all specification without prior notice.

Unilamp Co., Ltd.
461 Ramintra Road, Kannayao, Bangkok 10230 Thailand
Tel : +66(O)2 943 2420-1, +66(O)2 946 4170-1
Fax : +66(O)2 943 2419
online@unilamp.co.th
www.unilamp.co.th

ALPHA

MEDIUM ALPHA ROUND – ID

SPOTLIGHT



LAST UPDATE: 25-05-2026

Specification

IEC Standard	IEC 60598-1 General Requirement IEC 60598-2-1 Fixed Luminaires												
Protection	IP66 Class I												
IK Rating	Protection against mechanical impact IK10 on body and IK08 on optical part.												
Luminaires Body Housing	High-pressure die cast aluminum alloy body and components. Extruded aluminum 56063 alloy body with low copper content.												
Coating Process	Nano Ceramic surface conversion, resistant to corrosive environment. Luminaire primarily coated with epoxy resin and top coated with UV stabilized polyester powder and cured in digital temperature controlled chamber at 200°C.												
Diffuser	Impact resistant safety tempered glass cover. Able to withstand the temperature up to 250°C.												
Lens	Molded PC lens from renowned manufacturers in various light distribution patterns.												
Adjustable Optic	Adjustable aiming unit through graduated scale.												
Gasket	Post-cured treated silicone gasket. Temperature and weather resistant. Working temperature -40°C to +200°C.												
External Screws	External screws are in stainless steel with protection grease.												
Cable Entry	Cable entry protected by M20 cable gland. To be used with H05RN-F/ H07RN-F cable with 7-13mm. diameter.												
Led	High efficiency LED module utilized chips from world renowned manufacturer. Assembled on MCPCB and mounted on to heat conductive material.												
Driver	High quality CASAMBI controllable LED driver with constant current output. Conform to applicable safety standards and electromagnetic compatibility.												
Internal Wire	Tinned copper conductor with silicone insulated internal wire. IMQ approved. Working temperature -40°C to +180°C.												
Terminal Block	Terminal block in GFR PA6.6 for cable with cross section up to 2.5 sqmm. VDE approved. Class1 luminaire provided with the earth connection.												
Caution	Installation work has to be carried on according to the enclosed installation manual.												
Color	<table><tr><td></td><td>Black O1</td></tr><tr><td></td><td>Graphite O2</td></tr><tr><td></td><td>Dark Grey O3</td></tr><tr><td></td><td>Aluminum Silver O4</td></tr><tr><td></td><td>White O6</td></tr><tr><td></td><td>Corten O8</td></tr></table>		Black O1		Graphite O2		Dark Grey O3		Aluminum Silver O4		White O6		Corten O8
	Black O1												
	Graphite O2												
	Dark Grey O3												
	Aluminum Silver O4												
	White O6												
	Corten O8												

Light Distribution

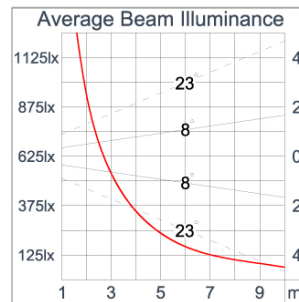
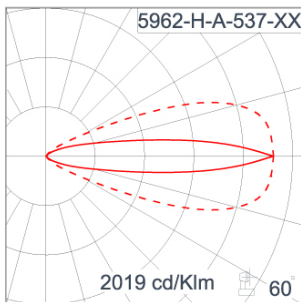

*Due to the constancy of product development, we reserve the right to alter all specification without prior notice.

Unilamp Co., Ltd.
461 Ramintra Road, Kannayao, Bangkok 10230 Thailand
Tel : +66(0)2 943 2420-1, +66(0)2 946 4170-1
Fax : +66(0)2 943 2419
online@unilamp.co.th
www.unilamp.co.th

ALPHA

MEDIUM ALPHA ROUND – ID SPOTLIGHT



LAST UPDATE: 25-05-2026

Bug Report

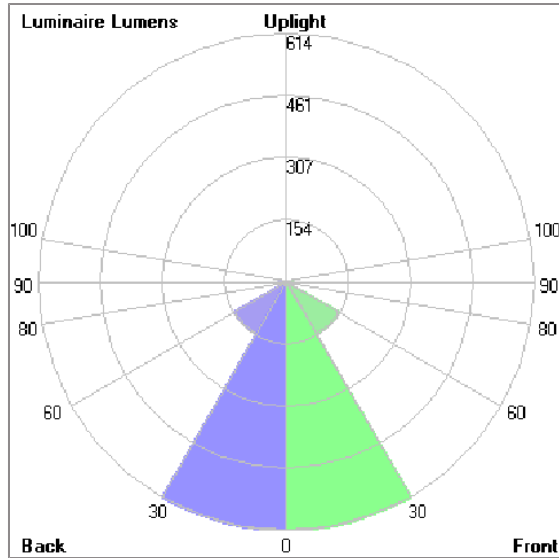

Lum. Classification System (LCS)

LCS	Zone	%Lumens	%Lamp	%Lum
FL	[0-30]	614.3	26.7	39.2
FM	[30-60]	147.8	6.4	9.4
FH	[60-80]	19.4	0.8	1.2
FVH	[80-90]	0.9	0.0	0.1
BL	[0-30]	614.3	26.7	39.2
BM	[30-60]	147.8	6.4	9.4
BH	[60-80]	19.4	0.8	1.2
BVH	[80-90]	0.9	0.0	0.1
UL	[90-100]	0.0	0.0	0.0
UH	[100-180]	2.4	0.1	0.2
Total		1567.2	67.9	100.0
BUG Rating		B2-U1-G0		

*Due to the constancy of product development,
we reserve the right to alter all specification
without prior notice.

ALPHA

MEDIUM ALPHA ROUND – ID

SPOTLIGHT



LAST UPDATE: 25-05-2026

Accessories



Ordering Code:
AUN-GHS-0016-00
Glare shield ring, COB



Ordering Code:
AUN-ACB-0014-00
Anchor bolt kit, bollard



Ordering Code:
AUN-CON-0009-00
IP68 connection device,
cable diameter 5-9.5mm,
On-Off



Ordering Code:
AUN-GSH-0012-00
Honeycomb louver, LED,
pre-assembly from factory



Ordering Code:
AUN-SOF-0026-00
Softening filter, LED,
pre-assembly from factory



Ordering Code:
AUN-CON-0013-00
IP68 connection device,
cable diameter 7-11.5mm,
On-Off



Ordering Code:
AUN-GHS-0028-XX
Glare shield cap



Ordering Code:
AUN-MOT-0013-XX
Pole mounting arm, for 1-3
projector



Ordering Code:
AUN-CLP-0008-XX
Pole clamp, pole diameter
102-105mm, for wall or
pole mounting arm



Ordering Code:
AUN-CLP-0009-XX
Pole clamp, pole diameter
60-76mm, for wall or pole
mounting arm



Ordering Code:
AUN-ESP-0001-00
Earth spike, GFR polymer



Ordering Code:
AUN-TRS-0001-00
Tree strap, small mounting
base

*Due to the constancy of product development,
we reserve the right to alter all specification
without prior notice.

Unilamp Co., Ltd.
461 Ramintra Road, Kannayao, Bangkok 10230 Thailand
Tel : +66[0]2 943 2420-1, +66[0]2 946 4170-1
Fax : +66[0]2 943 2419
online@unilamp.co.th
www.unilamp.co.th

ALPHA

MEDIUM ALPHA ROUND – ID

SPOTLIGHT



LAST UPDATE: 25-05-2026



Ordering Code:
AUN-ACB-0008-00
Anchor bolt kit, pole diameter 102mm and 151x102mm, galvanized steel pole



Ordering Code:
AUN-ACB-0005-00
Anchor bolt kit, aluminum pole



Ordering Code:
ALUMINUM-POLE-FOR-ALPHA-SPOTLIGHT
Please contact Sales Representative



Ordering Code:
STEEL-POLE-FOR-ALPHA-SPOTLIGHT
Please contact Sales Representative



Ordering Code:
AUN-MOT-0021-XX
Mounting base, rotatable, On-Off, pre-assembly from factory



Ordering Code:
AUN-POL-0043-XX
Cylindrical aluminum pole, diameter 105mm, H= 522mm, [pre-assembled from factory]



Ordering Code:
AUN-MOT-0018-XX
Outrigger arm, L= 740mm, On-Off, pre-assembly from factory



Ordering Code:
AUN-ESP-0008-XX
Earth spike, L= 900mm, aluminum, On-Off, pre-assembly from factory



Ordering Code:
AUN-MOT-0038-XX
Pole mount adaptor, rectangular pole, On-Off, pre-assembly from factory



Ordering Code:
AUN-MOT-0032-XX
Pole mount adaptor, pole diameter 60mm, On-Off, pre-assembly from factory



Ordering Code:
AUN-MOT-0034-XX
Pole mount adaptor, pole diameter 76mm, On-Off, pre-assembly from factory



Ordering Code:
AUN-MOT-0036-XX
Pole mount adaptor, pole diameter 102-105mm, On-Off, pre-assembly from factory

*Due to the constancy of product development, we reserve the right to alter all specification without prior notice.

Unilamp Co., Ltd.
461 Ramintra Road, Kannayao, Bangkok 10230 Thailand
Tel : +66[0]2 943 2420-1, +66[0]2 946 4170-1
Fax : +66[0]2 943 2419
online@unilamp.co.th
www.unilamp.co.th

ALPHA

MEDIUM ALPHA ROUND – ID

SPOTLIGHT



LAST UPDATE: 25-05-2026



Ordering Code:
AUN-CLP-0040-XX
Pole clamp, pole diameter
60-76mm, single side
luminaire mounting ,
On-Off, pre-assembly from
factory



Ordering Code:
AUN-CLP-0042-XX
Pole clamp, pole diameter
102-105mm, single side
luminaire mounting ,
On-Off, pre-assembly from
factory



Ordering Code:
AUN-CLP-0044-XX
Pole clamp, pole diameter
60-76mm, double sided
luminaire mounting ,
On-Off, pre-assembly from
factory



Ordering Code:
AUN-CLP-0046-XX
Pole clamp, pole diameter
102-105mm, double sided
luminaire mounting ,
On-Off, pre-assembly from
factory



Ordering Code:
AUN-ESP-0023-XX
Earth spike, L=
1390-1760mm, aluminum,
length adjustable, On-Off,
pre-assembly from factory

*Due to the constancy of product development,
we reserve the right to alter all specification
without prior notice.

Unilamp Co., Ltd.
461 Ramintra Road, Kannayao, Bangkok 10230 Thailand
Tel : +66[0]2 943 2420-1, +66[0]2 946 4170-1
Fax : +66[0]2 943 2419
online@unilamp.co.th
www.unilamp.co.th