

ALPHA

MEDIUM ALPHA ROUND – ID SPOTLIGHT



LAST UPDATE: 03-02-2026



ALPHA is an entirely new family of outdoor spotlights/floodlights engineered from scratch. The primary shapes and overall small dimensions make it possible to install ALPHA in most professional and residential lighting applications. High-quality polycarbonate optics provide accurate beam control and offer a wide selection of light distributions. ALPHA can be customized with accessories such as honeycombs, shields and various mounting solutions for poles and surfaces. The minimized amount of needed tools and usage of quick connectors simplifies the installation.

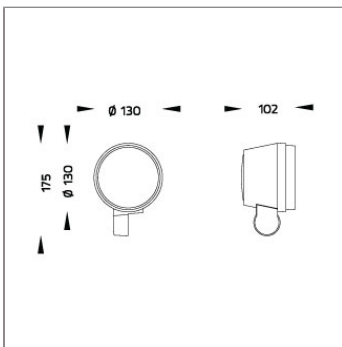

Technical Data



Ordering Code :	5962-D-3-505-XX
Lamp :	LED
Beam :	59°
CCT :	2700 K
CRI :	CRI >80
SDCM :	SDCM = 3
Lamp Lumen :	3160 lm
Luminaire Lumen :	2660 lm
Lamp Wattage :	23 W
Luminaire Wattage :	25 W
Efficacy :	106 lm/W
Ambient Temperature :	25°C
Lumen Maintenance	L70B10 >90,000 h
Controller :	On-Off
Input Voltage :	220-240Vac 50/60Hz
Net Weight :	- kg.

Ordering code guide

XXXX-X-X-XXX-XX

- A Product Code
- B Reflector
- C Electrical Component
- D Lamp
- E Color



Icon definition

*Due to the constancy of product development, we reserve the right to alter all specification without prior notice.

Unilamp Co., Ltd.
461 Ramintra Road, Kannayao, Bangkok 10230 Thailand
Tel : +66(O)2 943 2420-1, +66(O)2 946 4170-1
Fax : +66(O)2 943 2419
online@unilamp.co.th
www.unilamp.co.th

ALPHA

MEDIUM ALPHA ROUND – ID

SPOTLIGHT



LAST UPDATE: 03-02-2026

Specification

IEC Standard	IEC 60598-1 General Requirement IEC 60598-2-1 Fixed Luminaires
Protection	IP66 Class I
IK Rating	Protection against mechanical impact IK10 on body and IK08 on optical part.
Luminaires Body Housing	Durable high-pressure die-cast aluminum alloy for excellent mechanical performance.
Coating Process	The luminaire undergoes a Nano Ceramic surface conversion, making it highly resistant to corrosive environments. It is primarily coated with a durable epoxy resin and finished with a UV-stabilized polyester powder top coat. The coating process is completed by curing the luminaire in a digitally controlled temperature chamber at 200°C, ensuring exceptional durability and long-lasting protection aga
Diffuser	Impact-resistant tempered glass designed for high-temperature environments.
Lens	Advanced molded PC lens offering diverse light distribution patterns.
Adjustable Optic	Adjustable aiming mechanism with graduated scale for precision control.
Gasket	Advanced post-cured silicone gasket offering superior weather and thermal resistance [-40°C to +200°C].
External Screws	Durable stainless steel screws with anti-corrosion grease for extended lifespan.
Cable Entry	M20 cable gland for secure cable entry, compatible with H05RN-F/H07RN-F cables (7-13mm).
Led	COB LED module with high efficiency, mounted on MCPCB for superior thermal management.
Driver	Certified constant current LED driver meeting all EMC and safety requirements.
Internal Wire	Reliable silicone-insulated tinned copper internal wire, designed for -40°C to +180°C.
Terminal Block	Certified GFR PA6.6 terminal block supporting up to 2.5 sqmm cables. Grounded Class 1 luminaire ensuring proper earthing for secure operation.
Caution	Installation must be performed as per the provided installation instructions.
Color	 Black O1 Graphite O2 Dark Grey O3 Aluminum Silver O4 White O6 Corten O8

Light Distribution

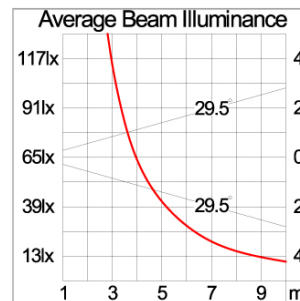
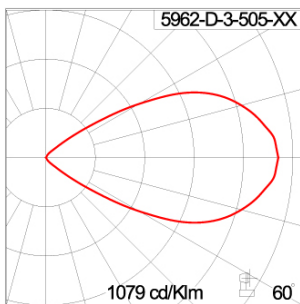

*Due to the constancy of product development, we reserve the right to alter all specification without prior notice.

Unilamp Co., Ltd.
461 Ramintra Road, Kannayao, Bangkok 10230 Thailand
Tel : +66(0)2 943 2420-1, +66(0)2 946 4170-1
Fax : +66(0)2 943 2419
online@unilamp.co.th
www.unilamp.co.th

ALPHA

MEDIUM ALPHA ROUND – ID SPOTLIGHT



LAST UPDATE: 03-02-2026

Bug Report

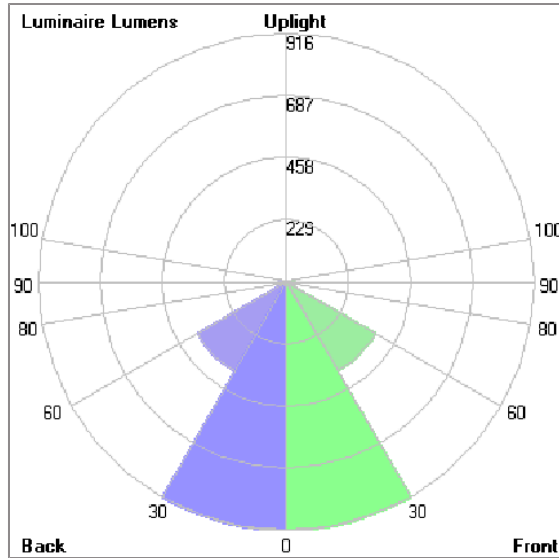

Lum. Classification System [LCS]

LCS	Zone	%Lumens	%Lamp	%Lum
FL	[0-30]	916.1	34.4	34.4
FM	[30-60]	379.9	14.3	14.3
FH	[60-80]	31.8	1.2	1.2
FVH	[80-90]	1.5	0.1	0.1
BL	[0-30]	916.1	34.4	34.4
BM	[30-60]	379.9	14.3	14.3
BH	[60-80]	31.8	1.2	1.2
BVH	[80-90]	1.5	0.1	0.1
UL	[90-100]	< 0.05	0.0	0.0
UH	[100-180]	1.0	0.0	0.0
Total		2659.6	100.0	100.0
BUG Rating		B2-U1-G0		

*Due to the constancy of product development,
we reserve the right to alter all specification
without prior notice.

Unilamp Co., Ltd.
461 Ramintra Road, Kannayao, Bangkok 10230 Thailand
Tel : +66[0]2 943 2420-1, +66[0]2 946 4170-1
Fax : +66[0]2 943 2419
online@unilamp.co.th
www.unilamp.co.th

ALPHA

MEDIUM ALPHA ROUND – ID

SPOTLIGHT



LAST UPDATE: 03-02-2026

Accessories



Ordering Code:
AUN-ACB-0014-00
Anchor bolt kit, bollard



Ordering Code:
AUN-CON-0009-00
IP68 connection device,
cable diameter 5-9.5mm,
On-Off



Ordering Code:
AUN-GSH-0012-00
Honeycomb louver, LED,
pre-assembly from factory



Ordering Code:
AUN-SOF-0026-00
Softening filter, LED,
pre-assembly from factory



Ordering Code:
AUN-CON-0013-00
IP68 connection device,
cable diameter 7-11.5mm,
On-Off



Ordering Code:
AUN-GHS-0028-XX
Glare shield cap



Ordering Code:
AUN-MOT-0013-XX
Pole mounting arm, for 1-3
projector



Ordering Code:
AUN-CLP-0008-XX
Pole clamp, pole diameter
102-105mm, for wall or
pole mounting arm



Ordering Code:
AUN-CLP-0009-XX
Pole clamp, pole diameter
60-76mm, for wall or pole
mounting arm



Ordering Code:
AUN-ESP-0001-00
Earth spike, GFR polymer



Ordering Code:
AUN-TRS-0001-00
Tree strap, small mounting
base



Ordering Code:
AUN-ACB-0008-00
Anchor bolt kit, pole
diameter 102mm and
151x102mm, galvanized
steel pole

*Due to the constancy of product development,
we reserve the right to alter all specification
without prior notice.

Unilamp Co., Ltd.
461 Ramintra Road, Kannayao, Bangkok 10230 Thailand
Tel : +66[0]2 943 2420-1, +66[0]2 946 4170-1
Fax : +66[0]2 943 2419
online@unilamp.co.th
www.unilamp.co.th

ALPHA

MEDIUM ALPHA ROUND – ID

SPOTLIGHT



LAST UPDATE: 03-02-2026



Ordering Code:
AUN-ACB-0005-00
Anchor bolt kit, aluminum pole



Ordering Code:
ALUMINUM-POLE-FOR-ALPHA-SPOTLIGHT
Please contact Sales Representative



Ordering Code:
STEEL-POLE-FOR-ALPHA-SPOTLIGHT
Please contact Sales Representative



Ordering Code:
AUN-MOT-0021-XX
Mounting base, rotateable, On-Off, pre-assembly from factory



Ordering Code:
AUN-POL-0043-XX
Cylindrical aluminum pole, diameter 105mm, H= 522mm, [pre-assembled from factory]



Ordering Code:
AUN-MOT-0018-XX
Outrigger arm, L= 740mm, On-Off, pre-assembly from factory



Ordering Code:
AUN-ESP-0008-XX
Earth spike, L= 900mm, aluminum, On-Off, pre-assembly from factory



Ordering Code:
AUN-MOT-0038-XX
Pole mount adaptor, rectangular pole, On-Off, pre-assembly from factory



Ordering Code:
AUN-MOT-0032-XX
Pole mount adaptor, pole diameter 60mm, On-Off, pre-assembly from factory



Ordering Code:
AUN-MOT-0034-XX
Pole mount adaptor, pole diameter 76mm, On-Off, pre-assembly from factory

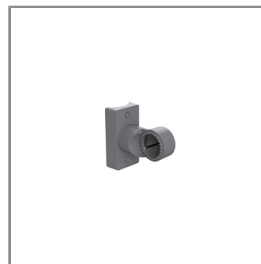

Ordering Code:
AUN-MOT-0036-XX
Pole mount adaptor, pole diameter 102-105mm, On-Off, pre-assembly from factory



Ordering Code:
AUN-CLP-0040-XX
Pole clamp, pole diameter 60-76mm, single side luminaire mounting, On-Off, pre-assembly from factory

*Due to the constancy of product development, we reserve the right to alter all specification without prior notice.

Unilamp Co., Ltd.
461 Ramintra Road, Kannayao, Bangkok 10230 Thailand
Tel : +66[0]2 943 2420-1, +66[0]2 946 4170-1
Fax : +66[0]2 943 2419
online@unilamp.co.th
www.unilamp.co.th

ALPHA

MEDIUM ALPHA ROUND – ID

SPOTLIGHT



LAST UPDATE: 03-02-2026



Ordering Code:
AUN-CLP-0042-XX
Pole clamp, pole diameter
102-105mm, single side
luminaire mounting ,
On-Off, pre-assembly from
factory



Ordering Code:
AUN-CLP-0044-XX
Pole clamp, pole diameter
60-76mm, double sided
luminaire mounting ,
On-Off, pre-assembly from
factory

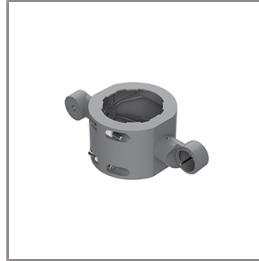

Ordering Code:
AUN-CLP-0046-XX
Pole clamp, pole diameter
102-105mm, double sided
luminaire mounting ,
On-Off, pre-assembly from
factory



Ordering Code:
AUN-ESP-0023-XX
Earth spike, L=
1390-1760mm, aluminum,
length adjustable, On-Off,
pre-assembly from factory