

# KUBIK

## MINI KUBIK – CVDA PROJECTOR



LAST UPDATE: 18-06-2024



KUBIK is a robust cube-shaped/rectangular-shaped spotlight/floodlight with LED and HID light source. The family offers ground/wall mount fixing, pole clamp and wall clamp array, indirect pole and indirect wall light. The front glass cover is flush to the luminaire housing thus dust and water are not accumulated. High-efficiency lenses and reflectors are used in this luminaire family. Aiming can be done through graduated scale by the tool. KUBIK is suitable to light up the object from short to medium distance for example bushes, plants, sculptures, flags, signboards, columns, building facets, playgrounds, open spaces etc. Full list of accessories is available as standard option.

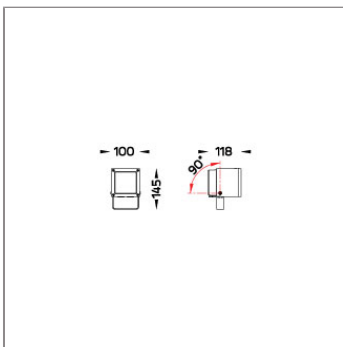

### Technical Data



Ordering Code :	5941-P-7-797-XX
Lamp :	LED
Beam :	Sharp Elliptical H
CCT :	2700 K
CRI :	CRI >80
SDCM :	SDCM = 3
Lamp Lumen :	1040 lm
Luminaire Lumen :	220 lm
Lamp Wattage :	8.4 W[24Vdc]
Luminaire Wattage :	8.4 W
Efficacy :	26 lm/W
Ambient Temperature :	50°C
Lumen Maintenance	L80B10 >108,000 h
Controller :	On-Off / DALI
Input Voltage :	24Vdc
Net Weight :	1.40 kg.

### Ordering code guide

XXXX-X-X-XXX-XX

A B C D E

- A Product Code
- B Reflector
- C Electrical Component
- D Lamp
- E Color



Icon definition









\*Due to the constancy of product development, we reserve the right to alter all specification without prior notice.

Unilamp Co., Ltd.  
461 Ramintra Road, Kannayao, Bangkok 10230 Thailand  
Tel : +66(O)2 943 2420-1, +66(O)2 946 4170-1  
Fax : +66(O)2 943 2419  
online@unilamp.co.th  
www.unilamp.co.th

### Specification

IEC Standard	IEC 60598-1 General Requirement IEC 60598-2-1 Fixed Luminaires
Protection	IP66 Class I
IK Rating	Protection against mechanical impact IK08 on body and IK07 optical part.
Luminaires Body Housing	High-pressure die cast aluminum alloy body and components.
Coating Process	Nano Ceramic surface conversion, resistant to corrosive environment. Luminaire primarily coated with epoxy resin and top coated with UV stabilized polyester powder and cured in digital temperature controlled chamber at 200°C.
Diffuser	Impact resistant safety tempered glass cover. Able to withstand the temperature up to 250°C. Glass flushes to the front cover, no accumulation of dust and water.
Lens	Molded PC lens from renowned manufacturers in various light distribution patterns.
Adjustable Optic	Adjustable aiming unit through graduated scale.
Gasket	Post-cured treated silicone gasket. Temperature and weather resistant. Working temperature -40°C to +200°C.
External Screws	External screws are in stainless steel with protection grease.
Cable Entry	Cable entry protected by M20 cable gland. To be used with H05RN-F/ H07RN-F cable with 7-13mm. diameter.
Led	High efficiency LED module utilized chips from world renowned manufacturer. Assembled on MCPCB and mounted on to heat conductive material.
Driver	Driver is not included and has to be ordered separately.
Internal Wire	Tinned copper conductor with silicone insulated internal wire. IMQ approved. Working temperature -40°C to +180°C.
Terminal Block	Terminal block in GFR PA6.6 for cable with cross section up to 2.5 sqmm. VDE approved.
Pre-Wire Cable	Pre-wired with 5-core cable for power [3x1 sqmm.] and dimming signal [2x0.35 sqmm.]. Equipped with anti-humidity kit.
Caution	Installation work has to be carried on according to the enclosed installation manual.

### Color

	Black 01	2 TONE COLOR		White-Dark Grey 21
	Graphite 02			Silver-Dark Grey 22
	Dark Grey 03			Silver-Graphite 23
	Aluminium Silver 04			
	White 06			
	Wooden Brown 07			

### Light Distribution

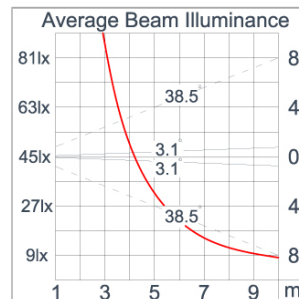
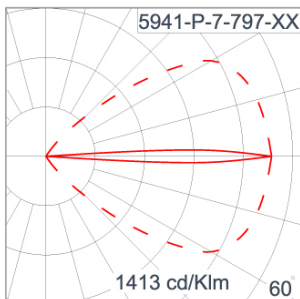

### Accessories

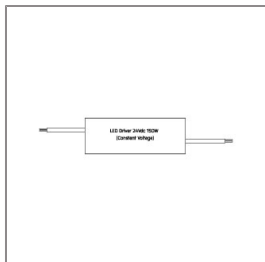

Ordering Code:  
AUN-DRG-0011-00  
LED constant voltage  
driver, 24VDC, 150W



Ordering Code:  
AUN-GHS-0015-XX  
Glare shield cap



Ordering Code:  
AUN-ESP-0005-00  
Earth spike, GFR polymer

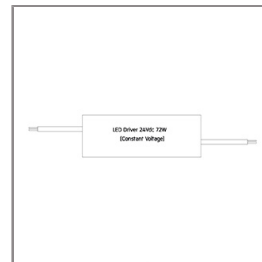

Ordering Code:  
AUN-DRG-0027-00  
LED constant voltage  
driver, 24VDC, 72W



Ordering Code:  
AUN-TRS-0005-00  
Tree strap

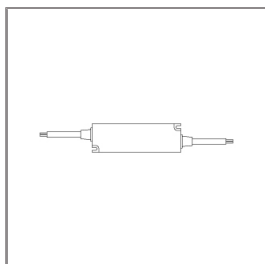

Ordering Code:  
AUN-DRG-0118-00  
LED constant voltage  
driver, 24VDC, 30W