

KUBIK

MINI KUBIK PROJECTOR



LAST UPDATE: 18-06-2024



KUBIK is a robust cube-shaped/rectangular-shaped spotlight/floodlight with LED and HID light source. The family offers ground/wall mount fixing, pole clamp and wall clamp array, indirect pole and indirect wall light. The front glass cover is flush to the luminaire housing thus dust and water are not accumulated. High-efficiency lenses and reflectors are used in this luminaire family. Aiming can be done through graduated scale by the tool. KUBIK is suitable to light up the object from short to medium distance for example bushes, plants, sculptures, flags, signboards, columns, building facets, playgrounds, open spaces etc. Full list of accessories is available as standard option.

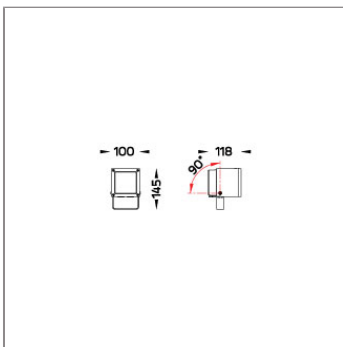

Technical Data



Ordering Code :	5941-A-3-531-XX
Lamp :	LED
Beam :	12°
CCT :	2700 K
CRI :	CRI >80
SDCM :	SDCM = 3
Lamp Lumen :	960 lm
Luminaire Lumen :	860 lm
Lamp Wattage :	8.1 W
Luminaire Wattage :	9.8 W
Efficacy :	87 lm/W
Ambient Temperature :	50°C
Lumen Maintenance	L70B10 >66,000 h
Controller :	On-Off
Input Voltage :	220-240Vac 50/60Hz
Net Weight :	1.60 kg.

Ordering code guide

XXXX-X-X-XXX-XX
A B C D E

- A Product Code
- B Reflector
- C Electrical Component
- D Lamp
- E Color



Icon definition









*Due to the constancy of product development, we reserve the right to alter all specification without prior notice.

Unilamp Co., Ltd.
461 Ramintra Road, Kannayao, Bangkok 10230 Thailand
Tel : +66(O)2 943 2420-1, +66(O)2 946 4170-1
Fax : +66(O)2 943 2419
online@unilamp.co.th
www.unilamp.co.th

Specification

IEC Standard	IEC 60598-1 General Requirement IEC 60598-2-1 Fixed Luminaires
Protection	IP66 Class I
IK Rating	Protection against mechanical impact IK08 on body and IK07 optical part.
Luminaires Body Housing	High-pressure die cast aluminum alloy body and components.
Coating Process	Nano Ceramic surface conversion, resistant to corrosive environment. Luminaire primarily coated with epoxy resin and top coated with UV stabilized polyester powder and cured in digital temperature controlled chamber at 200°C.
Diffuser	Impact resistant safety tempered glass cover. Able to withstand the temperature up to 250°C. Glass flushes to the front cover, no accumulation of dust and water.
Lens	Molded PC lens from renowned manufacturers in various light distribution patterns.
Adjustable Optic	Adjustable aiming unit through graduated scale.
Gasket	Post-cured treated silicone gasket. Temperature and weather resistant. Working temperature -40°C to +200°C.
External Screws	External screws are in stainless steel with protection grease.
Cable Entry	Cable entry protected by M20 cable gland. To be used with H05RN-F/ H07RN-F cable with 7-13mm. diameter.
Led	High efficiency LED module utilized chips from world renowned manufacturer. Assembled on MCPCB and mounted on to heat conductive material.
Driver	High quality constant current LED driver. Conform to safety standard and electromagnetic compatibility standard.
Internal Wire	Tinned copper conductor with silicone insulated internal wire. IMQ approved. Working temperature -40°C to +180°C.
Terminal Block	Terminal block in GFR PA6.6 for cable with cross section up to 2.5 sqmm. VDE approved.
Pre-Wire Cable	Pre-wired with 3x1.0 sqmm. H07RN-F neoprene cable. IMQ approved. Equipped with anti-humidity kit.
Caution	Installation work has to be carried on according to the enclosed installation manual.

Color

	Black 01	2 TONE COLOR		White-Dark Grey 21
	Graphite 02			Silver-Dark Grey 22
	Dark Grey 03			Silver-Graphite 23
	Aluminium Silver 04			
	White 06			
	Wooden Brown 07			

Light Distribution

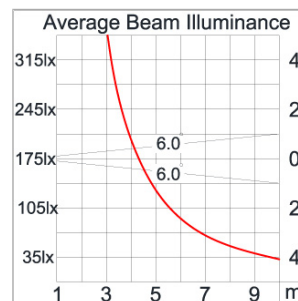
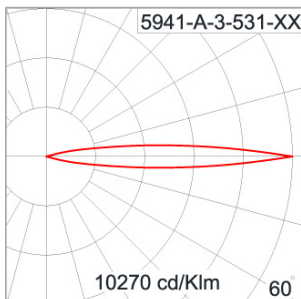

KUBIK

MINI KUBIK PROJECTOR



LAST UPDATE: 18-06-2024

Accessories



Ordering Code:
AUN-GSH-0008-00
Honeycomb louver, LED,
pre-assembly from factory

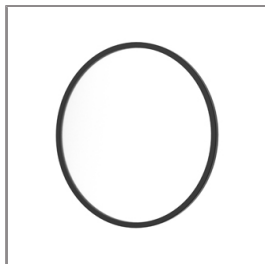

Ordering Code:
AUN-SOF-0022-00
Softening filter, LED,
pre-assembly from factory

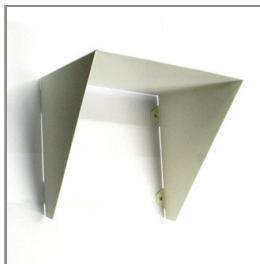

Ordering Code:
AUN-GHS-0015-XX
Glare shield cap



Ordering Code:
AUN-ESP-0005-00
Earth spike, GFR polymer



Ordering Code:
AUN-TRS-0005-00
Tree strap

*Due to the constancy of product development,
we reserve the right to alter all specification
without prior notice.

Unilamp Co., Ltd.
461 Ramintra Road, Kannayao, Bangkok 10230 Thailand
Tel : +66[0]2 943 2420-1, +66[0]2 946 4170-1
Fax : +66[0]2 943 2419
online@unilamp.co.th
www.unilamp.co.th