

SONIC

MEGA SONIC – GEAR ARM

PROJECTOR



LAST UPDATE: 30-05-2024



SONIC is a huge family of spotlight/floodlight with LED, HID and retrofit light source. The family offers ground/wall mount fixing, pole clamp and wall clamp array, indirect pole and wall light. The wide ranges of accessories like glare shield unit, tree strap, earth spike and anchorage bolt kit makes SONIC customizable for most application. Available in three sizes with a choice of six colors. SONIC is fitted with COB LED with high CRI in 2700K, 3000K or 4000K color temperature with 3 SDCM. The front glass cover is flush to the luminaire housing thus dust and water are not accumulated. High specular reflectors are used in this luminaire family to achieve an outstanding light output ratio. Aiming can be done through graduated scale by tool. For ease of installation and improved thermal performance the control gear compartment is housed separately to the light engine. SONIC is an ideal choice to accentuate sculptures, walls, building facades, bushes and trees.



Technical Data



Ordering Code :	5936-7-5-508-XX
Lamp :	LED
Beam :	37°
CCT :	2700 K
CRI :	CRI >80
SDCM :	SDCM = 3
Lamp Lumen :	7110 lm
Luminaire Lumen :	6320 lm
Lamp Wattage :	52 W
Luminaire Wattage :	57 W
Efficacy :	110 lm/W
Ambient Temperature :	25°C
Lumen Maintenance	L70B10 >90,000 h
Controller :	DALI
Input Voltage :	220-240Vac 50/60Hz
Net Weight :	7.60 kg.

Ordering code guide

XXXX-X-X-XXX-XX
A B C D E

- A Product Code
- B Reflector
- C Electrical Component
- D Lamp
- E Color



Icon definition

*Due to the constancy of product development, we reserve the right to alter all specification without prior notice.

Unilamp Co., Ltd.
461 Ramintra Road, Kannayao, Bangkok 10230 Thailand
Tel : +66(O)2 943 2420-1, +66(O)2 946 4170-1
Fax : +66(O)2 943 2419
online@unilamp.co.th
www.unilamp.co.th

Specification

IEC Standard	IEC 60598-1 General Requirement IEC 60598-2-1 Fixed Luminaires												
Protection	IP65 Class I												
IK Rating	Protection against mechanical impact IK08 on body and IK06 optical part.												
Luminaires Body Housing	High-pressure die cast aluminum alloy body and components. Extruded aluminum 56063 alloy body with low copper content.												
Coating Process	Nano ceramic surface conversion, resistant to corrosive environment. Luminaire primarily coated with epoxy resin and top coated with UV stabilized polyester powder and cured in digital temperature controlled chamber at 200°C.												
Diffuser	Impact resistant safety tempered glass cover. Able to withstand the temperature up to 250°C.												
Reflector	High performance anodized spun aluminum reflector.												
Adjustable Optic	Adjustable aiming unit through graduated scale.												
Gasket	Post-cured treated silicone gasket. Temperature and weather resistant. Working temperature -40°C to +200°C.												
External Screws	External screws are in stainless steel with protection grease.												
Cable Entry	Cable entry protected by M20 cable gland. To be used with H05RN-F/ H07RN-F cable with 7-13mm. diameter.												
Led	High efficiency LED module in COB technology. Assembled on MCPCB and mounted on to heat conductive material.												
Driver	High quality DALI Driver in constant current. Conform to applicable safety standards and electromagnetic compatibility.												
Internal Wire	Tinned copper conductor with silicone insulated internal wire. IMQ approved. Working temperature -40°C to +180°C. Tinned copper conductor with PTFE insulated internal wire. IMQ approved. Working temperature -40°C to +250°C.												
Terminal Block	Terminal block in GFR PA6.6 for cable with cross section up to 2.5 sqmm. VDE approved. Class1 luminaire provided with the earth connection.												
Caution	Installation work has to be carried on according to the enclosed installation manual.												
Color	<table border="0"> <tr><td></td><td>Black O1</td></tr> <tr><td></td><td>Graphite O2</td></tr> <tr><td></td><td>Dark Grey O3</td></tr> <tr><td></td><td>Aluminum Silver O4</td></tr> <tr><td></td><td>White O6</td></tr> <tr><td></td><td>Wooden Brown O7</td></tr> </table>		Black O1		Graphite O2		Dark Grey O3		Aluminum Silver O4		White O6		Wooden Brown O7
	Black O1												
	Graphite O2												
	Dark Grey O3												
	Aluminum Silver O4												
	White O6												
	Wooden Brown O7												

Light Distribution

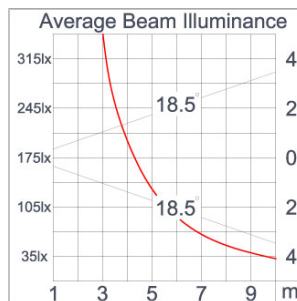
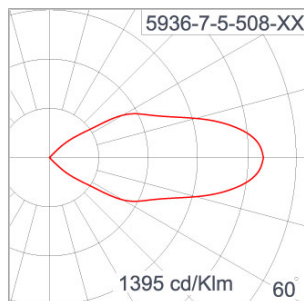

SONIC

MEGA SONIC – GEAR ARM PROJECTOR



LAST UPDATE: 30-05-2024

Accessories

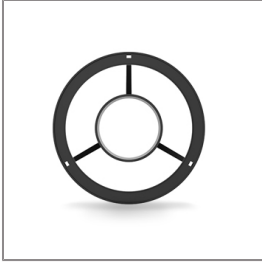

Ordering Code:
AUN-GHS-0022-00
Glare shield ring, COB



Ordering Code:
AUN-CAB-0003-00
Cable 3x1sqmm and
2x0.35sqmm, L= 2000,
with UniBlock
anti-humidity kit,
pre-assembly from factory

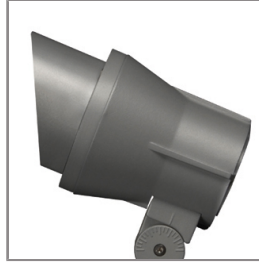

Ordering Code:
AUN-GHS-0003-XX
Glare shield cap

*Due to the constancy of product development,
we reserve the right to alter all specification
without prior notice.

Unilamp Co., Ltd.
461 Ramintra Road, Kannayao, Bangkok 10230 Thailand
Tel : +66(0)2 943 2420-1, +66(0)2 946 4170-1
Fax : +66(0)2 943 2419
online@unilamp.co.th
www.unilamp.co.th