

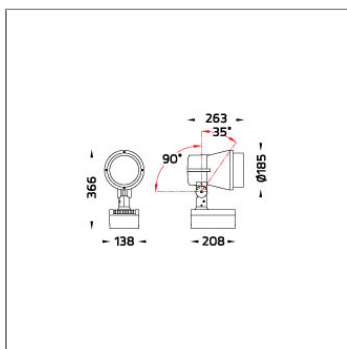

SONIC is a huge family of spotlight/floodlight with LED, HID and retrofit light source. The family offers ground/wall mount fixing, pole clamp and wall clamp array, indirect pole and wall light. The wide ranges of accessories like glare shield unit, tree strap, earth spike and anchorage bolt kit makes SONIC customizable for most application. Available in three sizes with a choice of six colors. SONIC is fitted with COB LED with high CRI in 2700K, 3000K or 4000K color temperature with 3 SDCM. The front glass cover is flush to the luminaire housing thus dust and water are not accumulated. High specular reflectors are used in this luminaire family to achieve an outstanding light output ratio. Aiming can be done through graduated scale by tool. For ease of installation and improved thermal performance the control gear compartment is housed separately to the light engine. SONIC is an ideal choice to accentuate sculptures, walls, building facades, bushes and trees.



Technical Data



Ordering Code :	5935-7-3-753-XX
Lamp :	HIT-CE
Socket :	G12
Beam :	38°
CCT :	3000-4200 K
Lamp Lumen :	14500 lm
Luminaire Lumen :	14500 lm
Lamp Wattage :	150 W
Luminaire Wattage :	150 W
Ambient Temperature :	25°C
Controller :	On-Off
Input Voltage :	230Vac 50Hz
Net Weight :	6.50 kg.

Ordering code guide

XXXX-X-X-XXX-XX

B
D

A
C
E

- A Product Code
- B Reflector
- C Electrical Component
- D Lamp
- E Color



Icon definition

Specification

IEC Standard	IEC 60598-1 General Requirement IEC 60598-2-1 Fixed Luminaires
Protection	IP65 Class I
IK Rating	Protection against mechanical impact IK08 on body and IK06 optical part.
Luminaires Body Housing	High-pressure die cast aluminum alloy body and components.
Coating Process	Nano ceramic surface conversion, resistant to corrosive environment. Luminaire primarily coated with epoxy resin and top coated with UV stabilized polyester powder and cured in digital temperature controlled chamber at 200°C.
Diffuser	Impact resistant safety tempered glass cover. Able to withstand the temperature up to 250°C.
Reflector	High performance anodized spun aluminum reflector.
Adjustable Optic	Adjustable aiming unit through graduated scale.
Gasket	Post-cured treated silicone gasket. Temperature and weather resistant. Working temperature -40°C to +200°C.
External Screws	External screws are in stainless steel with protection grease.
Cable Entry	Cable entry protected by M20 cable gland. To be used with H05RN-F/ H07RN-F cable with 7-13mm. diameter.
Lamp Holder	G12 lampholder in ceramic body. VDE/ ENEC approved.
Ballast	Vacuum impregnated magnetic ballast for HID lamp. ENEC approved.
Capacitor	Aluminium case capacitor with over pressure safety device. ENEC approved.
Ignitor	Electronic ignitor with automatic switch-off function. ENEC approved.
Internal Wire	Tinned copper conductor with silicone insulated internal wire. IMQ approved. Working temperature -40°C to +180°C. Tinned copper conductor with PTFE insulated internal wire. IMQ approved. Working temperature -40°C to +250°C.
Terminal Block	Terminal block in GFR PA6.6 for cable with cross section up to 2.5 sqmm. VDE approved. Class1 luminaire provided with the earth connection.
Caution	Installation work has to be carried on according to the enclosed installation manual.

Color	 Black O1  Graphite O2  Dark Grey O3  Aluminum Silver O4  White O6  Wooden Brown O7
-------	--

Light Distribution

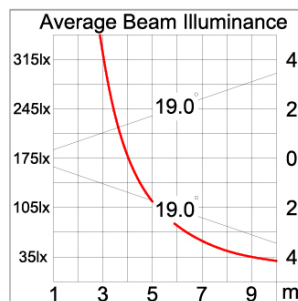
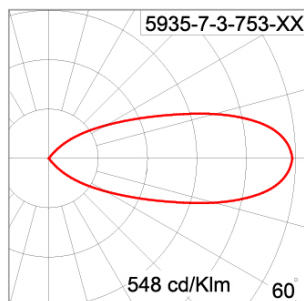

Accessories



Ordering Code:
AUN-CON-0009-00
IP68 connection device,
cable diameter 5-9.5mm,
On-Off



Ordering Code:
AUN-CON-0013-00
IP68 connection device,
cable diameter 7-11.5mm,
On-Off



Ordering Code:
AUN-CAB-0002-00
Cable H07RN-F 3x1sqmm,
L= 2000, with UniBlock
anti-humidity kit,
pre-assembly from factory



Ordering Code:
AUN-CLP-0004-XX
Pole clamp, pole diameter
102-105mm



Ordering Code:
AUN-MOT-0005-XX
Wall array, for 2 projector

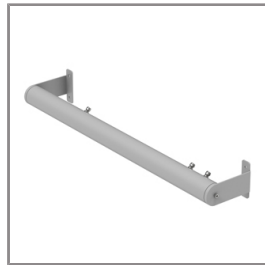

Ordering Code:
AUN-MOT-0006-XX
Wall array, for 4 projector

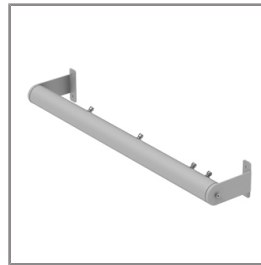

Ordering Code:
AUN-MOT-0007-XX
Wall array, for 6 projector

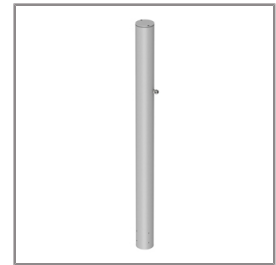

Ordering Code:
AUN-POL-0025-XX
Pole array for 2 projector



Ordering Code:
AUN-POL-0026-XX
Pole array for 4 projector

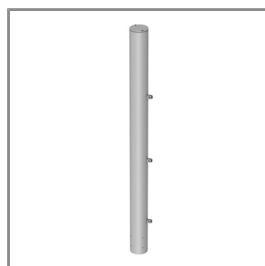

Ordering Code:
AUN-POL-0027-XX
Pole array for 6 projector



Ordering Code:
AUN-CAB-0004-00
Cable H07RN-F 3x1sqmm,
L= 500, with UniBlock
anti-humidity kit,
pre-assembly from factory

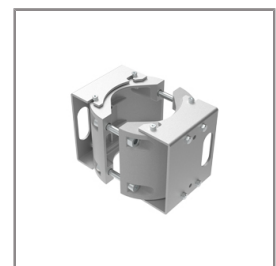

Ordering Code:
AUN-CLP-0006-XX
Pole clamp, pole diameter
60-76mm

SONIC

MEGA SONIC PROJECTOR



LAST UPDATE: 30-05-2024



Ordering Code:
AUN-MOT-0013-XX
Pole mounting arm, for 1-3
projector

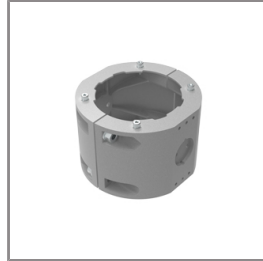

Ordering Code:
AUN-CLP-0008-XX
Pole clamp, pole diameter
102-105mm, for wall or
pole mounting arm

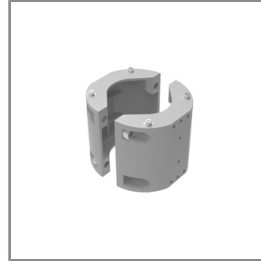

Ordering Code:
AUN-CLP-0009-XX
Pole clamp, pole diameter
60-76mm, for wall or pole
mounting arm

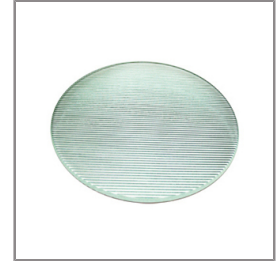

Ordering Code:
AUN-SOF-0005-00
Flat beam lens,
HIT-TC-CE, pre-assembly
from factory

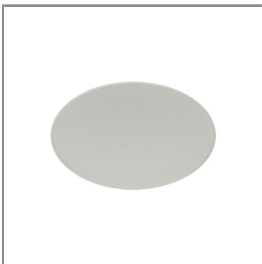

Ordering Code:
AUN-SOF-0012-00
Softening lens, HIT-CE,
pre-assembly from factory



Ordering Code:
AUN-GHS-0003-XX
Glare shield cap



Ordering Code:
AUN-GHS-0006-11
Glare shield ring, HIT-CE



Ordering Code:
AUN-ESP-0001-00
Earth spike, GFR polymer



Ordering Code:
AUN-TRS-0002-00
Tree strap, big mounting
base



Ordering Code:
ALUMINUM-POLE-FOR-MEGA-SONIC-POLE-ARRAY
Please contact Sales
Representative



Ordering Code:
ALUMINUM-POLE-FOR-MEGA-SONIC-POLE-ARRAY
Please contact Sales
Representative

*Due to the constancy of product development,
we reserve the right to alter all specification
without prior notice.

Unilamp Co., Ltd.
461 Ramintra Road, Kannayao, Bangkok 10230 Thailand
Tel : +66[0]2 943 2420-1, +66[0]2 946 4170-1
Fax : +66[0]2 943 2419
online@unilamp.co.th
www.unilamp.co.th