

SONIC

MEGA SONIC PROJECTOR



LAST UPDATE: 10-02-2025



SONIC is a huge family of spotlight/floodlight with LED, HID and retrofit light source. The family offers ground/wall mount fixing, pole clamp and wall clamp array, indirect pole and wall light. The wide ranges of accessories like glare shield unit, tree strap, earth spike and anchorage bolt kit makes SONIC customizable for most application. Available in three sizes with a choice of six colors. SONIC is fitted with COB LED with high CRI in 2700K, 3000K or 4000K color temperature with 3 SDCM. The front glass cover is flush to the luminaire housing thus dust and water are not accumulated. High specular reflectors are used in this luminaire family to achieve an outstanding light output ratio. Aiming can be done through graduated scale by tool. For ease of installation and improved thermal performance the control gear compartment is housed separately to the light engine. SONIC is an ideal choice to accentuate sculptures, walls, building facades, bushes and trees.



Technical Data



| | |
|-----------------------|--------------------|
| Ordering Code : | 5935-5-4-508-XX |
| Lamp : | LED |
| Beam : | 17° |
| CCT : | 2700 K |
| CRI : | CRI >80 |
| SDCM : | SDCM = 3 |
| Lamp Lumen : | 7110 lm |
| Luminaire Lumen : | 6470 lm |
| Lamp Wattage : | 52 W |
| Luminaire Wattage : | 57 W |
| Efficacy : | 113 lm/W |
| Ambient Temperature : | 50°C |
| Lumen Maintenance | L70B10 >90,000 h |
| Controller : | DIM 1-10V |
| Input Voltage : | 220-240Vac 50/60Hz |
| Net Weight : | 6.50 kg. |

Ordering code guide

XXXX-X-X-XXX-XX
A C E

- A Product Code
- B Reflector
- C Electrical Component
- D Lamp
- E Color



Icon definition

*Due to the constancy of product development, we reserve the right to alter all specification without prior notice.

Unilamp Co., Ltd.
461 Ramintra Road, Kannayao, Bangkok 10230 Thailand
Tel : +66(0)2 943 2420-1, +66(0)2 946 4170-1
Fax : +66(0)2 943 2419
online@unilamp.co.th
www.unilamp.co.th

Specification

| | | | | | | | | | | | | | |
|---|---|---|----------|---|-------------|---|--------------|---|--------------------|---|----------|---|-----------------|
| IEC Standard | IEC 60598-1 General Requirement IEC 60598-2-1 Fixed Luminaires | | | | | | | | | | | | |
| Protection | IP65 Class I | | | | | | | | | | | | |
| IK Rating | Protection against mechanical impact IK08 on body and IK06 optical part. | | | | | | | | | | | | |
| Luminaires Body Housing | High-pressure die cast aluminum alloy body and components. | | | | | | | | | | | | |
| Coating Process | Nano ceramic surface conversion, resistant to corrosive environment. Luminaire primarily coated with epoxy resin and top coated with UV stabilized polyester powder and cured in digital temperature controlled chamber at 200°C. | | | | | | | | | | | | |
| Diffuser | Impact resistant safety tempered glass cover. Able to withstand the temperature up to 250°C. | | | | | | | | | | | | |
| Reflector | High performance anodized spun aluminum reflector. | | | | | | | | | | | | |
| Adjustable Optic | Adjustable aiming unit through graduated scale. | | | | | | | | | | | | |
| Gasket | Post-cured treated silicone gasket. Temperature and weather resistant. Working temperature -40°C to +200°C. | | | | | | | | | | | | |
| External Screws | External screws are in stainless steel with protection grease. | | | | | | | | | | | | |
| Cable Entry | Cable entry protected by M20 cable gland. To be used with H05RN-F/ H07RN-F cable with 7-13mm. diameter. | | | | | | | | | | | | |
| Led | High efficiency LED module in COB technology. Assembled on MCPCB and mounted on to heat conductive material. | | | | | | | | | | | | |
| Driver | High quality Dimmable Driver [1-10V] in constant current. Conform to applicable safety standards and electromagnetic compatibility. | | | | | | | | | | | | |
| Internal Wire | Tinned copper conductor with silicone insulated internal wire. IMQ approved. Working temperature -40°C to +180°C. Tinned copper conductor with PTFE insulated internal wire. IMQ approved. Working temperature -40°C to +250°C. | | | | | | | | | | | | |
| Terminal Block | Terminal block in GFR PA6.6 for cable with cross section up to 2.5 sqmm. VDE approved. Class1 luminaire provided with the earth connection. | | | | | | | | | | | | |
| Caution | Installation work has to be carried on according to the enclosed installation manual. | | | | | | | | | | | | |
| Color | <table border="0"> <tr> <td></td> <td>Black O1</td> </tr> <tr> <td></td> <td>Graphite O2</td> </tr> <tr> <td></td> <td>Dark Grey O3</td> </tr> <tr> <td></td> <td>Aluminum Silver O4</td> </tr> <tr> <td></td> <td>White O6</td> </tr> <tr> <td></td> <td>Wooden Brown O7</td> </tr> </table> |  | Black O1 |  | Graphite O2 |  | Dark Grey O3 |  | Aluminum Silver O4 |  | White O6 |  | Wooden Brown O7 |
|  | Black O1 | | | | | | | | | | | | |
|  | Graphite O2 | | | | | | | | | | | | |
|  | Dark Grey O3 | | | | | | | | | | | | |
|  | Aluminum Silver O4 | | | | | | | | | | | | |
|  | White O6 | | | | | | | | | | | | |
|  | Wooden Brown O7 | | | | | | | | | | | | |

Light Distribution

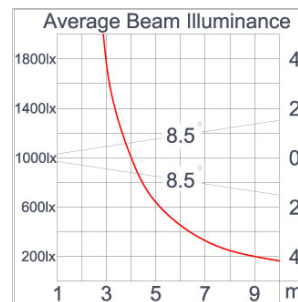
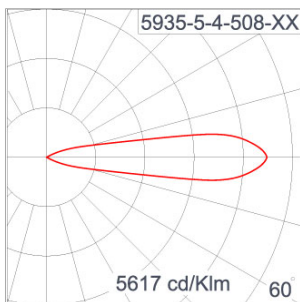

Accessories



Ordering Code:
AUN-CON-0011-00
IP68 connection device,
cable diameter 7.1-13mm,
1-10V or DALI



Ordering Code:
AUN-GHS-0022-00
Glare shield ring, COB



Ordering Code:
AUN-CON-0014-00
IP68 connection device,
cable diameter 8-12.5mm,
1-10V or DALI



Ordering Code:
AUN-CAB-0003-00
Cable 3x1sqmm and
2x0.35sqmm, L= 2000,
with UniBlock
anti-humidity kit,
pre-assembly from factory



Ordering Code:
AUN-CLP-0004-XX
Pole clamp, pole diameter
102-105mm



Ordering Code:
AUN-MOT-0005-XX
Wall array, for 2 projector



Ordering Code:
AUN-MOT-0006-XX
Wall array, for 4 projector



Ordering Code:
AUN-MOT-0007-XX
Wall array, for 6 projector



Ordering Code:
AUN-POL-0025-XX
Pole array for 2 projector



Ordering Code:
AUN-POL-0026-XX
Pole array for 4 projector



Ordering Code:
AUN-POL-0027-XX
Pole array for 6 projector



Ordering Code:
AUN-CLP-0006-XX
Pole clamp, pole diameter
60-76mm

SONIC

MEGA SONIC PROJECTOR



LAST UPDATE: 10-02-2025



Ordering Code:
AUN-MOT-0013-XX
Pole mounting arm, for 1-3
projector



Ordering Code:
AUN-CLP-0008-XX
Pole clamp, pole diameter
102-105mm, for wall or
pole mounting arm



Ordering Code:
AUN-CLP-0009-XX
Pole clamp, pole diameter
60-76mm, for wall or pole
mounting arm



Ordering Code:
AUN-GHS-0003-XX
Glare shield cap



Ordering Code:
AUN-ESP-0001-00
Earth spike, GFR polymer



Ordering Code:
AUN-TRS-0002-00
Tree strap, big mounting
base



Ordering Code:
ALUMINUM-POLE-FOR-MEGA-SONIC-POLE-ARRAY
Please contact Sales
Representative



Ordering Code:
STEEL-POLE-FOR-MEGA-SONIC-POLE-ARRAY
Please contact Sales
Representative

*Due to the constancy of product development,
we reserve the right to alter all specification
without prior notice.

Unilamp Co., Ltd.
461 Ramintra Road, Kannayao, Bangkok 10230 Thailand
Tel : +66(0)2 943 2420-1, +66(0)2 946 4170-1
Fax : +66(0)2 943 2419
online@unilamp.co.th
www.unilamp.co.th