

SPOTT

SPOTT – LED PROJECTOR



LAST UPDATE: 11-03-2025



SPOTT is a ground and wall mount spotlight. Accessories such as earth spike and tree strap are available for portable or temporary use. SPOTT is usually used to illuminate plants and trees, as well as signboards and other architectural tasks. It is suitable to light up objects from short to medium distance. The choices of beam angles are narrow, medium and wide. LED module and driver are made from market leader manufacturers.



Technical Data



| | |
|-----------------------|--------------------|
| Ordering Code : | 5901-7-4-887-XX |
| Lamp : | LED |
| Beam : | 48° |
| CCT : | 3000 K |
| CRI : | CRI >80 |
| SDCM : | SDCM = 3 |
| Lamp Lumen : | 3300 lm |
| Luminaire Lumen : | 2000 lm |
| Lamp Wattage : | 23 W |
| Luminaire Wattage : | 27 W |
| Efficacy : | 74 lm/W |
| Ambient Temperature : | 50°C |
| Lumen Maintenance | L70B10 >90,000 h |
| Controller : | DIM 1-10V |
| Input Voltage : | 220-240Vac 50/60Hz |
| Net Weight : | 2.90 kg. |

Ordering code guide

XXXX-X-X-XXX-XX
A B C D E

- A Product Code
- B Reflector
- C Electrical Component
- D Lamp
- E Color

















Icon definition

*Due to the constancy of product development, we reserve the right to alter all specification without prior notice.

Unilamp Co., Ltd.
461 Ramintra Road, Kannayao, Bangkok 10230 Thailand
Tel : +66(O)2 943 2420-1, +66(O)2 946 4170-1
Fax : +66(O)2 943 2419
online@unilamp.co.th
www.unilamp.co.th

Specification

| | | | | | | | | | | | |
|---|--|---|----------|---|-------------|---|--------------|---|--------------------|---|----------|
| IEC Standard | IEC 60598-1 General Requirement IEC 60598-2-1 Fixed Luminaires | | | | | | | | | | |
| Protection | IP65 Class I | | | | | | | | | | |
| IK Rating | Protection against mechanical impact IK10 on body and IK07 on optical part. | | | | | | | | | | |
| Luminaires Body Housing | High-pressure die cast aluminum alloy body and components. Extruded aluminum 56063 alloy body with low copper content. | | | | | | | | | | |
| Coating Process | Nano ceramic surface conversion, resistant to corrosive environment. Luminaire primarily coated with epoxy resin and top coated with UV stabilized polyester powder and cured in digital temperature controlled chamber at 200°C. | | | | | | | | | | |
| Diffuser | Impact resistant safety tempered glass cover. Able to withstand the temperature up to 250°C. | | | | | | | | | | |
| Reflector | High performance anodized spun aluminium reflector. | | | | | | | | | | |
| Adjustable Optic | Adjustable aiming unit through graduated scale. | | | | | | | | | | |
| Gasket | Post-cured treated silicone gasket. Temperature and weather resistant. Working temperature -40°C to +200°C. | | | | | | | | | | |
| External Screws | External screws are in stainless steel with protection grease. | | | | | | | | | | |
| Cable Entry | Cable entry protected by M20 cable gland. To be used with H05RN-F/ H07RN-F cable with 7-13mm. diameter. | | | | | | | | | | |
| Led | High efficiency LED module in COB technology. Assembled on MCPCB and mounted on to heat conductive material. | | | | | | | | | | |
| Driver | High quality Dimmable Driver (1-10V) in constant current. Conform to applicable safety standards and electromagnetic compatibility. | | | | | | | | | | |
| Internal Wire | Tinned copper conductor with silicone insulated internal wire. IMQ approved. Working temperature -40°C to +180°C. | | | | | | | | | | |
| Terminal Block | Terminal block in GFR PA6.6 for cable with cross section up to 2.5 sqmm. VDE approved. Class1 luminaire provided with the earth connection. | | | | | | | | | | |
| Caution | Installation work has to be carried on according to the enclosed installation manual. | | | | | | | | | | |
| Color | <table border="0"> <tr> <td></td> <td>Black 01</td> </tr> <tr> <td></td> <td>Graphite 02</td> </tr> <tr> <td></td> <td>Dark Grey 03</td> </tr> <tr> <td></td> <td>Aluminum Silver 04</td> </tr> <tr> <td></td> <td>White 06</td> </tr> </table> |  | Black 01 |  | Graphite 02 |  | Dark Grey 03 |  | Aluminum Silver 04 |  | White 06 |
|  | Black 01 | | | | | | | | | | |
|  | Graphite 02 | | | | | | | | | | |
|  | Dark Grey 03 | | | | | | | | | | |
|  | Aluminum Silver 04 | | | | | | | | | | |
|  | White 06 | | | | | | | | | | |

Light Distribution

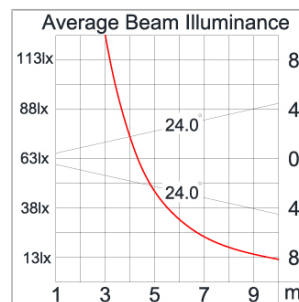
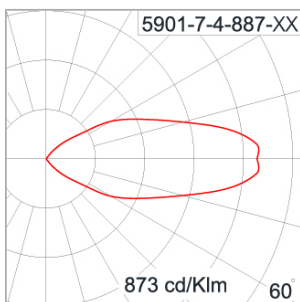

SPOTT

SPOTT – LED PROJECTOR



LAST UPDATE: 11-03-2025

Accessories



Ordering Code:
AUN-CON-0011-00
IP68 connection device,
cable diameter 7.1-13mm,
1-10V or DALI



Ordering Code:
AUN-CON-0014-00
IP68 connection device,
cable diameter 8-12.5mm,
1-10V or DALI



Ordering Code:
AUN-GHS-0025-00
Glare shield ring, COB



Ordering Code:
AUN-CAB-0003-00
Cable 3x1sqmm and
2x0.35sqmm, L= 2000,
with UniBlock
anti-humidity kit,
pre-assembly from factory



Ordering Code:
AUN-CLP-0004-XX
Pole clamp, pole diameter
102-105mm



Ordering Code:
AUN-CLP-0006-XX
Pole clamp, pole diameter
60-76mm



Ordering Code:
AUN-MOT-0013-XX
Pole mounting arm, for 1-3
projector



Ordering Code:
AUN-CLP-0008-XX
Pole clamp, pole diameter
102-105mm, for wall or
pole mounting arm



Ordering Code:
AUN-CLP-0009-XX
Pole clamp, pole diameter
60-76mm, for wall or pole
mounting arm



Ordering Code:
AUN-ESP-0001-00
Earth spike, GFR polymer



Ordering Code:
AUN-TRS-0001-00
Tree strap, small mounting
base



Ordering Code:
ALUMINUM-POLE-FOR-SPOTT
Please contact Sales
Representative

*Due to the constancy of product development,
we reserve the right to alter all specification
without prior notice.

Unilamp Co., Ltd.
461 Ramintra Road, Kannayao, Bangkok 10230 Thailand
Tel : +66[0]2 943 2420-1, +66[0]2 946 4170-1
Fax : +66[0]2 943 2419
online@unilamp.co.th
www.unilamp.co.th

SPOTT

SPOTT – LED
PROJECTOR

 **Unilamp**

LAST UPDATE: 11-03-2025



Ordering Code:
STEEL-POLE-FOR-SPOTT
Please contact Sales
Representative

*Due to the constancy of product development,
we reserve the right to alter all specification
without prior notice.

Unilamp Co., Ltd.
461 Ramintra Road, Kannayao, Bangkok 10230 Thailand
Tel : +66[0]2 943 2420-1, +66[0]2 946 4170-1
Fax : +66[0]2 943 2419
online@unilamp.co.th
www.unilamp.co.th