

SPOTT

SPOTT – LED PROJECTOR



LAST UPDATE: 30-05-2024



SPOTT is a ground and wall mount spotlight. Accessories such as earth spike and tree strap are available for portable or temporary use. SPOTT is usually used to illuminate plants and trees, as well as signboards and other architectural tasks. It is suitable to light up objects from short to medium distance. The choices of beam angles are narrow, medium and wide. LED module and driver are made from market leader manufacturers.

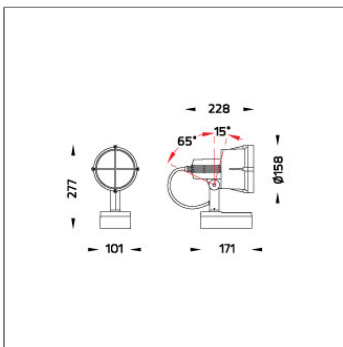

Technical Data



Ordering Code :	5901-5-4-506-XX
Lamp :	LED
Beam :	12°
CCT :	2700 K
CRI :	CRI >80
SDCM :	SDCM = 3
Lamp Lumen :	3160 lm
Luminaire Lumen :	2500 lm
Lamp Wattage :	23 W
Luminaire Wattage :	27 W
Efficacy :	92 lm/W
Ambient Temperature :	50°C
Lumen Maintenance	L70B10 >90,000 h
Controller :	DIM 1-10V
Input Voltage :	220-240Vac 50/60Hz
Net Weight :	2.90 kg.

Ordering code guide

XXXX-X-X-XXX-XX
A B C D E

- A Product Code
- B Reflector
- C Electrical Component
- D Lamp
- E Color





















Icon definition

*Due to the constancy of product development, we reserve the right to alter all specification without prior notice.

Unilamp Co., Ltd.
461 Ramintra Road, Kannayao, Bangkok 10230 Thailand
Tel : +66(O)2 943 2420-1, +66(O)2 946 4170-1
Fax : +66(O)2 943 2419
online@unilamp.co.th
www.unilamp.co.th

Specification

IEC Standard	IEC 60598-1 General Requirement IEC 60598-2-1 Fixed Luminaires												
Protection	IP65 Class I												
IK Rating	Protection against mechanical impact IK10 on body and IK07 on optical part.												
Luminaires Body Housing	High-pressure die cast aluminum alloy body and components. Extruded aluminum 56063 alloy body with low copper content.												
Coating Process	Nano ceramic surface conversion, resistant to corrosive environment. Luminaire primarily coated with epoxy resin and top coated with UV stabilized polyester powder and cured in digital temperature controlled chamber at 200°C.												
Diffuser	Impact resistant safety tempered glass cover. Able to withstand the temperature up to 250°C.												
Reflector	High performance anodized spun aluminium reflector.												
Adjustable Optic	Adjustable aiming unit through graduated scale.												
Gasket	Post-cured treated silicone gasket. Temperature and weather resistant. Working temperature -40°C to +200°C.												
External Screws	External screws are in stainless steel with protection grease.												
Cable Entry	Cable entry protected by M20 cable gland. To be used with H05RN-F/ H07RN-F cable with 7-13mm. diameter.												
Led	High efficiency LED module in COB technology. Assembled on MCPCB and mounted on to heat conductive material.												
Driver	High quality Dimmable Driver (1-10V) in constant current. Conform to applicable safety standards and electromagnetic compatibility.												
Internal Wire	Tinned copper conductor with silicone insulated internal wire. IMQ approved. Working temperature -40°C to +180°C.												
Terminal Block	Terminal block in GFR PA6.6 for cable with cross section up to 2.5 sqmm. VDE approved. Class1 luminaire provided with the earth connection.												
Caution	Installation work has to be carried on according to the enclosed installation manual.												
Color	<table border="0"> <tr> <td></td> <td>Black O1</td> </tr> <tr> <td></td> <td>Graphite O2</td> </tr> <tr> <td></td> <td>Dark Grey O3</td> </tr> <tr> <td></td> <td>Aluminum Silver O4</td> </tr> <tr> <td></td> <td>White O6</td> </tr> <tr> <td></td> <td>Wooden Brown O7</td> </tr> </table>		Black O1		Graphite O2		Dark Grey O3		Aluminum Silver O4		White O6		Wooden Brown O7
	Black O1												
	Graphite O2												
	Dark Grey O3												
	Aluminum Silver O4												
	White O6												
	Wooden Brown O7												

Light Distribution

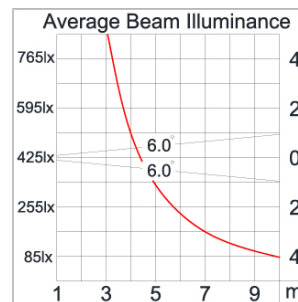
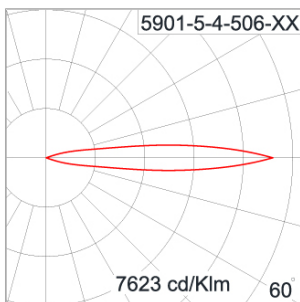

SPOTT

SPOTT – LED PROJECTOR



LAST UPDATE: 30-05-2024

Accessories



Ordering Code:
AUN-CON-0011-00
IP68 connection device,
cable diameter 7.1-13mm,
1-10V or DALI



Ordering Code:
AUN-CON-0014-00
IP68 connection device,
cable diameter 8-12.5mm,
1-10V or DALI



Ordering Code:
AUN-GHS-0025-00
Glare shield ring, COB



Ordering Code:
AUN-CAB-0003-00
Cable 3x1sqmm and
2x0.35sqmm, L= 2000,
with UniBlock
anti-humidity kit,
pre-assembly from factory



Ordering Code:
AUN-CLP-0004-XX
Pole clamp, pole diameter
102-105mm



Ordering Code:
AUN-CLP-0006-XX
Pole clamp, pole diameter
60-76mm



Ordering Code:
AUN-MOT-0013-XX
Pole mounting arm, for 1-3
projector



Ordering Code:
AUN-CLP-0008-XX
Pole clamp, pole diameter
102-105mm, for wall or
pole mounting arm



Ordering Code:
AUN-CLP-0009-XX
Pole clamp, pole diameter
60-76mm, for wall or pole
mounting arm



Ordering Code:
AUN-ESP-0001-00
Earth spike, GFR polymer



Ordering Code:
AUN-TRS-0001-00
Tree strap, small mounting
base



Ordering Code:
ALUMINUM-POLE-FOR-SPOTT
Please contact Sales
Representative

*Due to the constancy of product development,
we reserve the right to alter all specification
without prior notice.

Unilamp Co., Ltd.
461 Ramintra Road, Kannayao, Bangkok 10230 Thailand
Tel : +66[0]2 943 2420-1, +66[0]2 946 4170-1
Fax : +66[0]2 943 2419
online@unilamp.co.th
www.unilamp.co.th

SPOTT

SPOTT – LED
PROJECTOR

 **Unilamp**

LAST UPDATE: 30-05-2024



Ordering Code:
STEEL-POLE-FOR-SPOTT
Please contact Sales
Representative

*Due to the constancy of product development,
we reserve the right to alter all specification
without prior notice.

Unilamp Co., Ltd.
461 Ramintra Road, Kannayao, Bangkok 10230 Thailand
Tel : +66[0]2 943 2420-1, +66[0]2 946 4170-1
Fax : +66[0]2 943 2419
online@unilamp.co.th
www.unilamp.co.th