

NEOS

NEOS PROJECTOR



LAST UPDATE: 18-06-2024



NEOS is a small sized high performing area light. Outstanding optical efficacy, high ambient temperature rating and a wide range of mounting accessory makes NEOS a highly competitive product. The smooth curved design eliminates accumulation of water and dust. The unobtrusive slim design is a great match for commercial and residential lighting tasks. The area light can be either equipped with a photocell, DALI-2 control or basic on-off control gear. NEOS can be equipped with mounting accessories for pole integrated mounting, pole bracket, wall and wall corner. The pole bracket is suitable for Pole diameters up to 105mm.



Technical Data



Ordering Code :	2356-I-A-669-XX
Lamp :	LED
Beam :	T2
CCT :	4000 K
CRI :	CRI >80
SDCM :	SDCM = 3
Lamp Lumen :	4440 lm
Luminaire Lumen :	3570 lm
Lamp Wattage :	23 W
Luminaire Wattage :	25 W
Efficacy :	142 lm/W
Ambient Temperature :	50°C
Lumen Maintenance	L70B10 >72,000 h
Controller :	CASAMBI
Input Voltage :	220-240Vac 50/60Hz
Net Weight :	2.80 kg.

Ordering code guide

XXXX-X-X-XXX-XX
A B C D E

- A Product Code
- B Reflector
- C Electrical Component
- D Lamp
- E Color



Icon definition

*Due to the constancy of product development, we reserve the right to alter all specification without prior notice.

Unilamp Co., Ltd.
461 Ramintra Road, Kannayao, Bangkok 10230 Thailand
Tel : +66(O)2 943 2420-1, +66(O)2 946 4170-1
Fax : +66(O)2 943 2419
online@unilamp.co.th
www.unilamp.co.th

Specification

IEC Standard	IEC 60598-1 General Requirement IEC 60598-2-1 Fixed Luminaires												
Protection	IP66 Class I												
IK Rating	Protection against mechanical impact IK08 on body and optical part.												
Luminaires Body Housing	High-pressure die cast aluminum alloy body and components.												
Coating Process	Nano Ceramic surface conversion, resistant to corrosive environment. Luminaire primarily coated with epoxy resin and top coated with UV stabilized polyester powder and cured in digital temperature controlled chamber at 200°C.												
Diffuser	Impact resistant safety tempered glass cover. Able to withstand the temperature up to 250°C.												
Lens	Molded PC lens from renowned manufacturers in various light distribution patterns.												
Adjustable Optic	Adjustable aiming unit through graduated scale.												
Gasket	Post-cured treated silicone gasket. Temperature and weather resistant. Working temperature -40°C to +200°C.												
External Screws	External screws are in stainless steel with protection grease.												
Cable Entry	Cable entry protected by weather proof grommet. To be used with HO5RN-F/ HO7RN-F cable with 6-13mm. diameter.												
Led	High efficiency LED module utilized chips from world renowned manufacturer. Assembled on MCPCB and mounted on to heat conductive material.												
Driver	High quality CASAMBI controllable LED driver with constant current output. Conform to applicable safety standards and electromagnetic compatibility.												
Enhanced Protection	The luminaire is equipped with a 10kV surge protection device, the function of the protector is indicated by a LED, performance in compliance with IEC61643-11.												
Internal Wire	Tinned copper conductor with silicone insulated internal wire. IMQ approved. Working temperature -40°C to +180°C.												
Terminal Block	Terminal block in GFR PA6.6 for cable with cross section up to 2.5 sqmm. VDE approved. Class1 luminaire provided with the earth connection.												
Pre-Wire Cable	Pre-wired with 3x1.0 sqmm. HO7RN-F neoprene cable. IMQ approved.												
Caution	Installation work has to be carried on according to the enclosed installation manual.												
Color	<table border="0"> <tr> <td></td> <td>Black O1</td> </tr> <tr> <td></td> <td>Graphite O2</td> </tr> <tr> <td></td> <td>Dark Grey O3</td> </tr> <tr> <td></td> <td>Aluminum Silver O4</td> </tr> <tr> <td></td> <td>White O6</td> </tr> <tr> <td></td> <td>Wooden Brown O7</td> </tr> </table>		Black O1		Graphite O2		Dark Grey O3		Aluminum Silver O4		White O6		Wooden Brown O7
	Black O1												
	Graphite O2												
	Dark Grey O3												
	Aluminum Silver O4												
	White O6												
	Wooden Brown O7												

Light Distribution

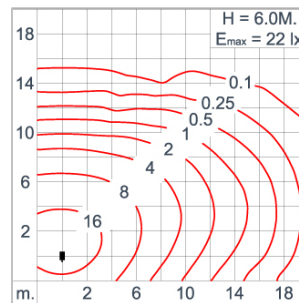
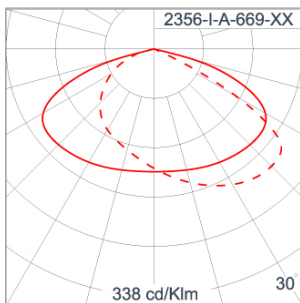

NEOS

NEOS PROJECTOR



LAST UPDATE: 18-06-2024

Accessories



Ordering Code:
AUN-CON-0009-00
IP68 connection device,
cable diameter 5-9.5mm,
On-Off



Ordering Code:
AUN-CON-0010-00
IP68 connection device 3
pole, cable diameter
5-9.5mm, with distribution
block



Ordering Code:
AUN-CON-0013-00
IP68 connection device,
cable diameter 7-11.5mm,
On-Off



Ordering Code:
AUN-SEN-0001-00
Photocell, On-Off,
pre-assembly from factory



Ordering Code:
AUN-MOT-0008-XX
Pole mount adaptor,
rectangular pole



Ordering Code:
AUN-MOT-0009-XX
Pole mount adaptor, pole
diameter 60mm



Ordering Code:
AUN-MOT-0010-XX
Pole mount adaptor, pole
diameter 76mm



Ordering Code:
AUN-MOT-0011-XX
Pole mount adaptor for
pole dia 102-105mm.



Ordering Code:
AUN-RCH-0012-XX
Mounting base, rotateable



Ordering Code:
AUN-MOT-0020-XX
Mounting base, rotateable



Ordering Code:
AUN-MOT-0012-XX
Wall spacer



Ordering Code:
AUN-BRK-0002-XX
Corner mounting bracket

*Due to the constancy of product development,
we reserve the right to alter all specification
without prior notice.

Unilamp Co., Ltd.
461 Ramintra Road, Kannayao, Bangkok 10230 Thailand
Tel : +66[0]2 943 2420-1, +66[0]2 946 4170-1
Fax : +66[0]2 943 2419
online@unilamp.co.th
www.unilamp.co.th

NEOS

NEOS

PROJECTOR

 **Unilamp**

LAST UPDATE: 18-06-2024



Ordering Code:

AUN-GHS-0032-XX

Glare shield cap,

pre-assembly from factory

*Due to the constancy of product development,
we reserve the right to alter all specification
without prior notice.

Unilamp Co., Ltd.
461 Ramintra Road, Kannayao, Bangkok 10230 Thailand
Tel : +66[0]2 943 2420-1, +66[0]2 946 4170-1
Fax : +66[0]2 943 2419
online@unilamp.co.th
www.unilamp.co.th