

FIN

FIN ARM HID PROJECTOR



LAST UPDATE: 29-05-2024



FIN is a series of floodlights with Symmetric and Bi-symmetric light distribution. Fin is equipped with High Power LED module available in 2700K, 3000K and 4000K with high CRI. It is also available in traditional HID light source. The aluminium reflectors and PC lenses used in this luminaire are designed by high-end lighting engineering software. The graduated scale provides precise aiming of the luminaire. The range of accessories such as ground mount spike, tree strap and glare shield cap makes FIN a dynamic floodlight choice. FIN is suitable to light up small to medium sized objects or areas such as signage boards, ceiling, building facades, etc.

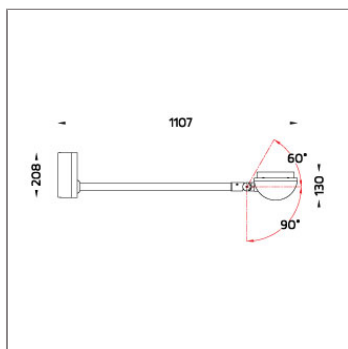

Technical Data



Ordering Code :	2303-7-3-784-XX
Lamp :	HIT-DE-CE
Socket :	RX7s-24
Beam :	Bi-Symmetric
CCT :	3000-4200 K
Lamp Lumen :	14200 lm
Luminaire Lumen :	14200 lm
Lamp Wattage :	150 W
Luminaire Wattage :	150 W
Ambient Temperature :	25°C
Controller :	On-Off
Input Voltage :	220-240Vac 50/60Hz
Net Weight :	7.50 kg.

Ordering code guide

XXXX-X-X-XXX-XX

A B C D E

- A Product Code
- B Reflector
- C Electrical Component
- D Lamp
- E Color





















Icon definition

*Due to the constancy of product development, we reserve the right to alter all specification without prior notice.

Unilamp Co., Ltd.
461 Ramintra Road, Kannayao, Bangkok 10230 Thailand
Tel : +66(O)2 943 2420-1, +66(O)2 946 4170-1
Fax : +66(O)2 943 2419
online@unilamp.co.th
www.unilamp.co.th

Specification

IEC Standard	IEC 60598-1 General Requirement IEC 60598-2-1 Fixed Luminaires												
Protection	IP65 Class I												
IK Rating	Protection against mechanical impact IK08 on body and IK07 optical part.												
Luminaires Body Housing	High-pressure die cast aluminum alloy body and components. Extruded aluminum 56063 alloy body with low copper content.												
Coating Process	Nano Ceramic surface conversion, resistant to corrosive environment. Luminaire primarily coated with epoxy resin and top coated with UV stabilized polyester powder and cured in digital temperature controlled chamber at 200°C.												
Diffuser	Impact resistant safety tempered glass cover. Able to withstand the temperature up to 250°C.												
Reflector	High performance CNC forming aluminum reflector sheet.												
Adjustable Optic	Adjustable aiming unit through graduated scale.												
Gasket	Post-cured treated silicone gasket. Temperature and weather resistant. Working temperature -40°C to +200°C.												
External Screws	External screws are in stainless steel with protection grease.												
Cable Entry	Cable entry protected by M20 cable gland. To be used with H05RN-F/ H07RN-F cable with 7-13mm. diameter.												
Lamp Holder	RX7s/ RX7s-24 in ceramic body. IMQ/ ENEC approved.												
Ballast	Electronic ballast for HID lamp. ENEC approved.												
Internal Wire	Tinned copper conductor with silicone insulated internal wire. IMQ approved. Working temperature -40°C to +180°C. HID control gear wired with double insulated silicone cable and compatible to be operated under ignition voltage up to 5KV.												
Terminal Block	Terminal block in GFR PA6.6 for cable with cross section up to 2.5 sqmm. VDE approved. Class1 luminaire provided with the earth connection.												
Caution	Installation work has to be carried on according to the enclosed installation manual.												
Color	<table border="0"> <tr> <td></td> <td>Black O1</td> </tr> <tr> <td></td> <td>Graphite O2</td> </tr> <tr> <td></td> <td>Dark Grey O3</td> </tr> <tr> <td></td> <td>Aluminum Silver O4</td> </tr> <tr> <td></td> <td>White O6</td> </tr> <tr> <td></td> <td>Wooden Brown O7</td> </tr> </table>		Black O1		Graphite O2		Dark Grey O3		Aluminum Silver O4		White O6		Wooden Brown O7
	Black O1												
	Graphite O2												
	Dark Grey O3												
	Aluminum Silver O4												
	White O6												
	Wooden Brown O7												

Light Distribution

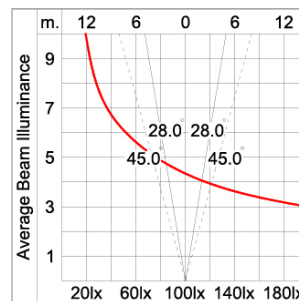
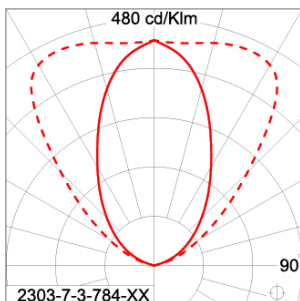

FIN

FIN ARM HID PROJECTOR



LAST UPDATE: 29-05-2024

Accessories



Ordering Code:
AUN-CAB-0002-00
Cable H07RN-F 3x1sqmm,
L= 2000, with UniBlock
anti-humidity kit,
pre-assembly from factory



Ordering Code:
AUN-CAB-0004-00
Cable H07RN-F 3x1sqmm,
L= 500, with UniBlock
anti-humidity kit,
pre-assembly from factory

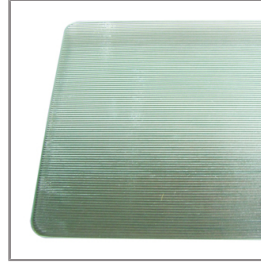

Ordering Code:
AUN-SOF-0013-00
Flat beam lens, Non LED,
pre-assembly from factory

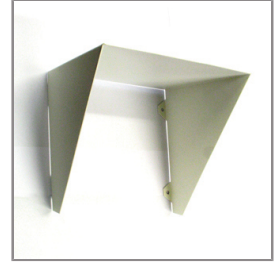

Ordering Code:
AUN-GHS-0014-XX
Glare shield cap